

# FLEXIBLE STORAGE SOLUTIONS

---



# WHY CHOOSE US?

## ROUSSEAU IS THE LEADING DESIGNER AND MANUFACTURER OF FLEXIBLE AND HIGH-QUALITY STORAGE SOLUTIONS. READ ON TO FIND OUT WHY:

### INNOVATIVE PRODUCTS AND PROCESSES

Innovation runs through the whole company! Every team within Rousseau is focused on developing products, continuously improving processes and integrating the latest technology.

At Rousseau, we proudly implement sustainable development initiatives in terms of both our products and manufacturing processes.

### FLEXIBLE AND CUSTOMIZED SOLUTIONS

Whatever the industry and whoever the customer, Rousseau understands that there is no one-size-fits-all solution. That's why all our product lines allow for custom configurations.

With our vast range of components and accessories, you can build your own solution, be it a customized cabinet, shelving system or workstation.

### MODULAR AND SCALABLE DESIGN

Our products are modular. They fit together easily to form complete systems. Furthermore, they are designed to accept a wide range of accessories, which allows highly personalized solutions to be created.

Our products are scalable. Our products are scalable and our solutions will grow along with your business. For example, if you already have a shelving system, you can add banks of drawers for storing small parts.

### MYMODEL-R

With the MyModel-r configuration tool, in just a few clicks you can build an R toolbox (stationary or mobile), shelving unit (with or without drawers), TekZone Hutch or R2V Vertical Drawer Cabinet.

As a Rousseau distributor, you can use a banner and/or personalized URL to link your website and the MyModel-r web page, so that a customer from your website is easily referred to you when they configure a model. Contact our Customer Service for your banner and personalized URL.

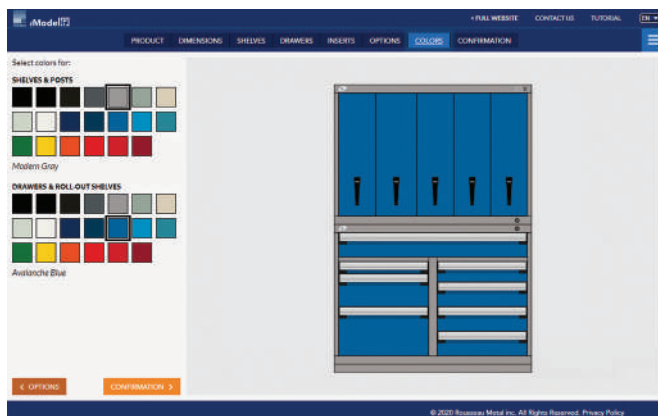

### DESIGNED AND MANUFACTURED IN NORTH AMERICA

By designing and manufacturing our products in North America, we have complete control over the quality produced.

In addition, we can accept orders on demand and offer excellent shipping times. We are also able to manufacture more tailored solutions for customers' special requests.

### UNRIVALED QUALITY AND DURABILITY

400 lb. capacity per drawer, lifetime warranty on the sliding system, meticulous designers, advanced technology and exceptional customer service. These are just some of the value-added benefits that come with Rousseau products.

By choosing Rousseau as a partner for your project, you are guaranteeing decades of satisfaction.

### CUSTOMER-FOCUSED IN EVERYTHING WE DO

The customer is always a key factor in Rousseau's decision making. Right from a product's initial concept phase, our team consults customers to find out what they really need.

For manufacturing, Rousseau uses quality materials and strict standards to ensure each customer can benefit from the best return on investment.



New Product



New Dimensions



New Model



Improved



Patented



Patent Pending



Design Patent



Design Patent Pending



Registered Trademark

## MANUFACTURING TOOL STORAGE

At Rousseau, we are always looking for innovative ways to optimize storage and maximize use of space. As we work in the metal transformation and manufacturing sector, we fully appreciate the challenges of storing the associated tools, such as punches and dies used for punching and bending metal.

Because we already had a section dedicated to NC tool storage, we have simply expanded and renamed it to "Manufacturing Tool Storage." [See pages 268 to 297.](#)



### VTZ (VERTICAL TOOL ZONE) CABINET

With VTZ (Vertical Tool Zone) Vertical Storage, you can store many different tools used for machining and bending in a relatively small floor area. [See pages 273 and 289.](#)



### BENDING TOOLS

The tools used for bending sheet metal are heavy and come in many different forms. To store them regardless of their shape, size or weight, we offer a RF62 reinforced drawer fitted with a structural partition. [See page 291.](#)

In addition, we have designed adjustable trays for storing tools upright. [See page 285.](#)

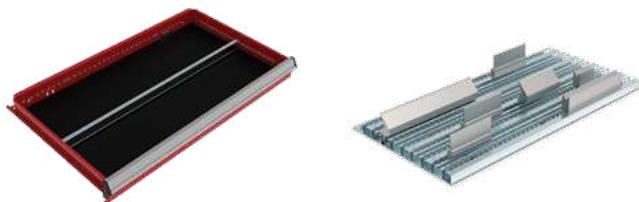

### PUNCHING TOOLS

Easy-to-use partitions, dividers and groove trays are great options for storing punching tools. As well as these accessories, we have designed storage racks for these tools. [See page 280.](#)

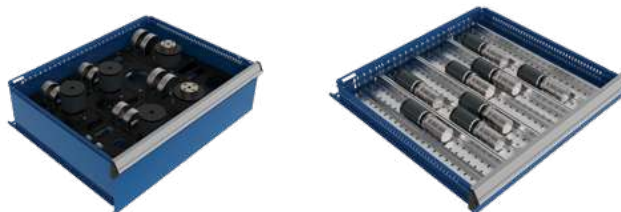

### SHELVING WITH SLIDING PANELS

Compatible with open and closed Spider® Shelving, this type of storage is ideal for hanging a wide range of items: tools, straps, cables, pipes, gaskets, etc. [See pages 89 and 103.](#)

The panels are compatible with many 5S accessories, including light-duty and heavy-duty hooks, tool holders and can holders.

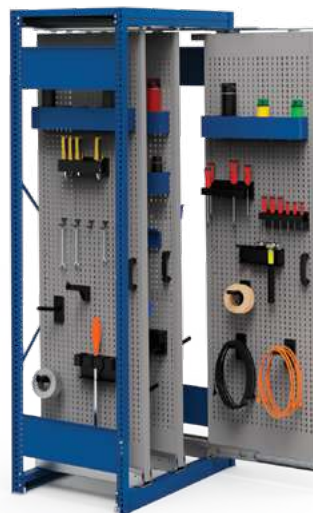

### POWER FEED PANELS

We have upgraded the USB ports included on our power feed panels. The panels now have one type "A" USB port and one type "C" USB port.



# TABLE OF CONTENTS

## CABINETS

### R HEAVY-DUTY MODULAR CABINET

INTRODUCTION ..... 4-5

#### PRECONFIGURED MODELS

24" Wide ..... 6  
 30" Wide ..... 6-7  
 36" Wide ..... 7  
 48" Wide ..... 8  
 54" Wide ..... 9  
 60" Wide ..... 10

#### ACCESSORIES

Security Accessories and Recommendations ..... 11  
 Cabinet Tops ..... 12-14  
 Stacking Cabinets ..... 14  
 Power Feed Panels and Cover Panels ..... 15  
 Computer Mounts ..... 16  
 Side Panels ..... 17  
 ESD Protection ..... 17  
 Waste & Recycling Cabinets and Sink Cabinet ..... 18

#### COMPONENTS

Housings ..... 19  
 Bases ..... 20-21  
 Drawers, Shelves and Locking/Security Mechanisms ..... 21-22  
 Doors, Handle and Locks ..... 23-25

### L COMPACT CABINET

INTRODUCTION ..... 26

#### PRECONFIGURED MODELS

24" High/28" High ..... 27  
 34" High/40" High ..... 28  
 Drawer Compartments ..... 29-30

#### ACCESSORIES

Security Accessories ..... 31  
 Drawer and Handle Accessories ..... 32-33  
 Cabinet Tops ..... 34  
 ESD Protection ..... 35  
 Bases ..... 35  
 Stacking Cabinets ..... 35

#### COMPONENTS

..... 36-37

## MOBILE CABINET

### R HEAVY-DUTY MOBILE CABINET

INTRODUCTION ..... 38-39

#### PRECONFIGURED MODELS

24" Wide ..... 40  
 30" and 36" Wide ..... 41-42  
 48" Wide ..... 42  
 54" Wide ..... 43  
 60" Wide ..... 43  
 48"(2x24) and 60"(2x30) ..... 44

#### ACCESSORIES

Security Accessories and Recommendations ..... 44-45  
 Cabinet Tops ..... 46-47  
 Tops Accessories ..... 47  
 Hanging Side Cabinets ..... 48  
 Side Panels ..... 49  
 Available Combinations ..... 49

#### COMPONENTS

Housings ..... 50  
 Doors ..... 51  
 Drawers, Shelves and Locking/Security Mechanisms ..... 52-53  
 Mobility ..... 54

### SMART COMPACT MOBILE L CABINET

INTRODUCTION ..... 55

#### PRECONFIGURED MODELS

18" Wide ..... 56  
 36" Wide ..... 57  
 54" Wide ..... 57

#### ACCESSORIES

Security mechanisms ..... 58-59  
 Drawer and Handle Accessories ..... 59-60  
 Cabinets Tops ..... 61  
 Top Accessories ..... 62

#### COMPONENTS

Housings/Doors ..... 63  
 Mobility ..... 64-65

## R MULTI-DRAWER CABINET

INTRODUCTION ..... 66-67

#### PRECONFIGURED MODELS –

##### R MULTI-DRAWER MOBILE CABINETS

48" Wide ..... 68  
 54" Wide ..... 69  
 60" Wide ..... 70

#### PRECONFIGURED MODELS –

##### R MULTI-DRAWER STATIONARY CABINETS

48" Wide ..... 71-72  
 54" Wide ..... 72  
 60" Wide ..... 73

#### ACCESSORIES

Side Panels ..... 74  
 Security Mechanisms ..... 75

## R2V VERTICAL STORAGE

INTRODUCTION ..... 76-79

#### PRECONFIGURED MODELS

24" Wide ..... 79  
 30" Wide ..... 80  
 36" Wide ..... 80  
 48" Wide ..... 80  
 54" Wide ..... 81  
 60" Wide ..... 81  
 Vertical Drawer Interiors ..... 82

#### ACCESSORIES

..... 83

#### COMPONENTS

..... 84-85

## SPIDER® SHELVING SYSTEM

INTRODUCTION ..... 86-87

#### PRECONFIGURED MODELS

##### INDUSTRIAL SHELVING

36"W, 42"W and 48"W Single Shelving Units, Open and Closed ..... 88  
 36"W, 42"W and 48"W Back-to-Back Shelving, Open and Closed ..... 89  
 87"H Closed Shelving with Accessories ..... 89  
 Shelving with Sliding Panels ..... 90

##### SHELVING WITH MODULAR DRAWERS

Shelving with 18"H, 24"H, 36"H and 48"H Banks of Modular Drawers ..... 91-92

#### ACCESSORIES

Dividers ..... 93  
 Label Holders ..... 93  
 Panels ..... 94-95  
 LED Lights ..... 95  
 Doors, Handles and Locks ..... 95-96  
 Miscellaneous Rails and Holders ..... 97-98  
 Modular Drawers and Roll-Out Shelves ..... 99  
 Locking and Security Mechanisms ..... 100

#### COMPONENTS

Structural Components ..... 101-103  
 Installation Accessories ..... 103  
 Shelves and Shelf Accessories ..... 103-105

## SHELVING WITH SLOPED SHELVES

INTRODUCTION ..... 106

#### PRECONFIGURED MODELS

Open and Closed Shelving ..... 107  
 Back-to-Back Open and Closed Shelving ..... 108  
 FIFO Open Shelving ..... 109

#### COMPONENTS

Shelves and Shelf Accessories ..... 110-111  
 Structural Components ..... 111-113  
 Installation Accessories ..... 113

## MINI-RACKING

INTRODUCTION ..... 114-115

#### PRECONFIGURED MODELS

Mini-Racking with Choice of Decking ..... 116-117  
 Mini-Racking for Standard-Sized Wood Decking ..... 118

#### ACCESSORIES

..... 119-121

#### COMPONENTS

Structural Components ..... 122  
 Beams and Tie Bars ..... 123  
 Mini-Racking Decking ..... 124-125

## MOBILE SHELVING AND MINI-RACKING

INTRODUCTION ..... 126

#### PRECONFIGURED MODELS

Mobile Shelving ..... 127  
 Mobile Mini-Racking ..... 128

#### COMPONENTS - MOBILITY

..... 129

## DRAWERS FOR SHELVING

INTRODUCTION ..... 130-131

#### PRECONFIGURED MODELS

..... 132-133

#### COMPONENTS

Drawers, Shelves and Locking or Security Mechanisms ..... 134  
 Mounting Brackets ..... 135

#### ACCESSORIES

..... 136

#### ASSEMBLY AND SECURITY RECOMMENDATIONS

Stacking Brackets and Assembly ..... 137

## BASIC WORKBENCH

INTRODUCTION ..... 138-139

#### PRECONFIGURED MODELS

Basic Workbenches ..... 140-143

#### COMPONENTS

Work Surfaces ..... 144-146

#### COMPONENTS - STRUCTURE

##### UNDER THE WORK SURFACE

Structural Component ..... 146-151  
 Preconfigured Cabinets ..... 152  
 Standard Drawer Units ..... 153  
 Heavy-Duty Drawer Units ..... 153

## WORK CENTERS WS / WM

INTRODUCTION ..... 154-155

#### PRECONFIGURED MODELS

Workbench with Riser Shelves ..... 156  
 Workbench with WM Bench Frames ..... 156-160

#### COMPONENTS

##### STRUCTURE ABOVE THE WORK SURFACE

Riser Shelves ..... 161-162  
 WM Bench Frame ..... 163-168  
 Polycarbonate Protective Panels ..... 168-169  
 Storage Cabinets ..... 169-170  
 Electronic Components ..... 171

## TEKZONE HUTCH

INTRODUCTION ..... 172

#### PRECONFIGURED MODELS

..... 173-174

#### STEP BY STEP

4 Easy Steps ..... 175  
 Dimensions and Panel Types ..... 176  
 Power Feed Panel ..... 176-177  
 Choice of Top ..... 177

#### ACCESSORIES

..... 178-179

## WORK CENTER R

INTRODUCTION ..... 180

#### COMPONENTS

..... 181-183

## CORNER WORKSTATION

INTRODUCTION ..... 184

#### PRECONFIGURED MODELS

..... 185-186

#### STEP BY STEP

Corner Workstations - 0030 ..... 187  
 Corner Workstations - 0630 ..... 188  
 Corner Workstations - 1230 ..... 189  
 Corner Workstations - 1830 ..... 190

#### ACCESSORIES

Corner Workstation Accessories ..... 191

#### TAKE INSPIRATION FROM THE ALPHABET

..... 191

## MULTITEK CART

**INTRODUCTION** . . . . . 192-193  
 Shelf and Intermediate Shelf Dimensions . . . . . 194  
 Drawer and Roll-Out Shelf Dimensions . . . . . 195

**DRAWER COMPARTMENTS**  
 25" x 16" Carts. . . . . 196  
 31" x 21" Carts. . . . . 197-198

**PRECONFIGURED MODELS**  
 25" x 16" Carts. . . . . 199-200  
 31" x 21" Carts. . . . . 201-202  
 36" x 24" Carts. . . . . 203  
 48" x 24" Carts. . . . . 204

**ACCESSORIES** . . . . . 205-207

## FREESTANDING STATION

**INTRODUCTION** . . . . . 208

**PRECONFIGURED MODELS** . . . . . 209-210

**COMPONENTS** . . . . . 211

## 5S AND WALL-MOUNTED STORAGE

**INTRODUCTION** . . . . . 212

**COMPONENTS**  
 Organizational Wall Structures. . . . . 213  
 Hooks and Holders . . . . . 214-215  
 5S Identification. . . . . 216  
 Drawer Accessories. . . . . 216  
 Wall Mounted Workstation. . . . . 217

## MODULAR DRAWER

**INTRODUCTION** . . . . . 218-219  
 Modular Drawers and Roll-Out Shelves. . . . . 220  
 Drawer and Roll-Out Shelf Dimensions . . . . . 220-222  
 How to Order a Drawer . . . . . 223  
 How to Order a Roll-Out Shelf . . . . . 223

**PRECONFIGURED MODELS**  
 18" x 21" (W x D) Drawers. . . . . 224  
 18" x 24" (W x D) Drawers. . . . . 224  
 18" x 27" (W x D) Drawers. . . . . 225  
 24" x 21" (W x D) Drawers. . . . . 225  
 24" x 24" (W x D) Drawers. . . . . 226  
 24" x 27" (W x D) Drawers. . . . . 227  
 30" x 18" (W x D) Drawers. . . . . 227  
 30" x 21" (W x D) Drawers. . . . . 228  
 30" x 24" (W x D) Drawers. . . . . 228  
 30" x 27" (W x D) Drawers . . . . . 229  
 36" x 18" (W x D) Drawers. . . . . 230  
 36" x 24" (W x D) Drawers. . . . . 231  
 36" x 27" (W x D) Drawers. . . . . 232  
 42" x 18" (W x D) Drawers. . . . . 233  
 42" x 24" (W x D) Drawers. . . . . 234  
 48" x 18" (W x D) Drawers. . . . . 235  
 48" x 24" (W x D) Drawers. . . . . 236  
 48" x 27" (W x D) Drawers. . . . . 237  
 54" x 24" (W x D) Drawers. . . . . 238  
 54" x 27" (W x D) Drawers. . . . . 239  
 60" x 24" (W x D) Drawers. . . . . 240  
 60" x 27" (W x D) Drawers . . . . . 241

**ACCESSORIES**  
 Subdividing Accessories . . . . . 242  
 Label Holders and Handle Protector. . . . . 243  
 Drawer Accessories. . . . . 244-246  
 Locking and Security Mechanisms. . . . . 247

## COMPUTER STATION

**INTRODUCTION** . . . . . 248

**PRECONFIGURED MODELS**  
 Computer Cabinet . . . . . 249-250  
 Wall-Mounted Computer Cabinet . . . . . 251  
 Workstation . . . . . 252  
 Freestanding stations . . . . . 253

**COMPONENTS**  
 Computer Cabinet . . . . . 254-256  
 Accessories Under the Work Surface . . . . . 256  
 Computer Mounts for Work Surfaces. . . . . 257  
 Computer Mounts for WM Frames and Wall Mounted Applications. . . . . 258-259

## RECORD STORAGE

**INTRODUCTION** . . . . . 260

**PRECONFIGURED MODELS**  
 Shelving for Record Storage . . . . . 261  
 Mini-Racking for Record Storage. . . . . 261

**COMPONENTS**  
 Posts, Braces and Box Shelves . . . . . 262  
 Beams, Tie Bars and Wood Decking . . . . . 263  
 Installation Accessories . . . . . 263

## MULTI-LEVEL STORAGE

### MULTI-LEVEL SHELVING

**INTRODUCTION** . . . . . 264

**EXPERTISE THAT LEAVES NOTHING TO CHANCE** . . . . . 265

**SOLUTIONS** . . . . . 265

### STACK & STORE CABINET MEZZANINE

**INTRODUCTION** . . . . . 266

**STACK & STORE COMPONENTS** . . . . . 267

## MANUFACTURING TOOL STORAGE

**INTRODUCTION** . . . . . 268-269

**MACHINING TOOL STORAGE SOLUTIONS**

**INTRODUCTION** . . . . . 270

**PRECONFIGURED MODELS** . . . . . 271-273

**COMPONENTS**  
 Tool Racks . . . . . 274-276  
 Tool Rack Adaptors . . . . . 277-279

### PUNCH TOOL STORAGE SOLUTIONS

**INTRODUCTION** . . . . . 280

**PRECONFIGURED MODELS/COMPONENTS**  
Stationary Cabinets  
 32" High . . . . . 281  
 40" High . . . . . 281  
 60" High . . . . . 281  
Mobile Cabinets  
 37½" High . . . . . 282  
 41½" High . . . . . 282  
Drawer Interiors  
 30"W x 27"D Drawers . . . . . 283  
 36"W x 27"D Drawers . . . . . 284  
 Punching Tool Racks . . . . . 284

### BENDING TOOL STORAGE SOLUTIONS

**INTRODUCTION** . . . . . 285

**PRECONFIGURED MODELS** . . . . . 286-289  
 Stationary Cabinets. . . . . 286  
 Mobile Cabinets. . . . . 287  
 Change Cart. . . . . 288  
 VTZ Cabinets for Bending Tools. . . . . 289

**COMPONENTS** . . . . . 290-291  
Bending Tool Shelves and Trays  
 Universal Shelf for VTZ Cabinets. . . . . 290  
 Adjustable Shelves for VTZ Cabinets . . . . . 290  
 Adjustable Trays for R Drawers . . . . . 290  
Drawer Components  
 Heavy-Duty Divider . . . . . 291  
 Rubber Mat . . . . . 291  
 Heavy-Duty Tool Drawer. . . . . 291

## CABINET FOR TWO USERS 292-293

## KEY TYPES - L3 / L50 294-296

## SUSTAINABLE DEVELOPMENT 297-298

## SHOWCASE 299-303

## NOTES 304

## STANDARD COLORS 305

# R HEAVY-DUTY MODULAR CABINET



INDEX	PAGE(S)
<b>R Heavy-Duty</b>	
<b>Modular Cabinet</b>	<b>4 - 5</b>
Preconfigured Models . . . . .	6 - 10
Accessories . . . . .	11 - 18
Components . . . . .	19 - 25
<b>L Compact Cabinet</b>	<b>26</b>
Preconfigured Models	
- Cabinets . . . . .	27 - 28
- Drawer compartments . . . . .	29 - 30
Accessories . . . . .	31 - 35
Components . . . . .	36 - 37

## R HEAVY-DUTY MODULAR CABINET

Specially designed for intensive use, R Heavy-Duty Stationary Cabinets are the ideal solution for the diverse needs of our customers. They are market-leading products thanks to the wide range of dimensions and accessories available, their modular design and, above all, their durability.

Each of the 7 widths come in different depths for a total of 15 different work surface sizes. Each of these is available in 7 heights. And with 10 different drawer heights, you have an incredible choice of possible configurations to suit the intended purpose of the cabinet.

Rousseau's R cabinet was tested by an independent laboratory and proved to be the most durable on the market. The tests also showed the superiority of our drawers. This is why we proudly and confidently offer a lifetime warranty on the drawer rolling system.

The unique design of the R drawer is a trademark of Rousseau Metal Inc.

As well as being built for the toughest tasks, Rousseau cabinets boast stylish and distinctive aesthetics that stand the test of time: a timeless design, designed to last.



R5XEE-1006



**LIFETIME WARRANTY**

The Rousseau drawer rolling mechanism is covered by a lifetime warranty.

# R HEAVY-DUTY MODULAR CABINET

## THE ROUSSEAU DIFFERENCE



A robust and distinctive design that is ideal for all environments.



10 drawer heights and 7 door heights available.



True North American dimensions allow for perfect modularity.



The housings have predefined fixing zones for installation of add-ons such as work surfaces, shelves, etc.



Industry-leading 400lb. load capacity per drawer.

## GENERAL DIMENSIONS

### HEIGHTS AVAILABLE

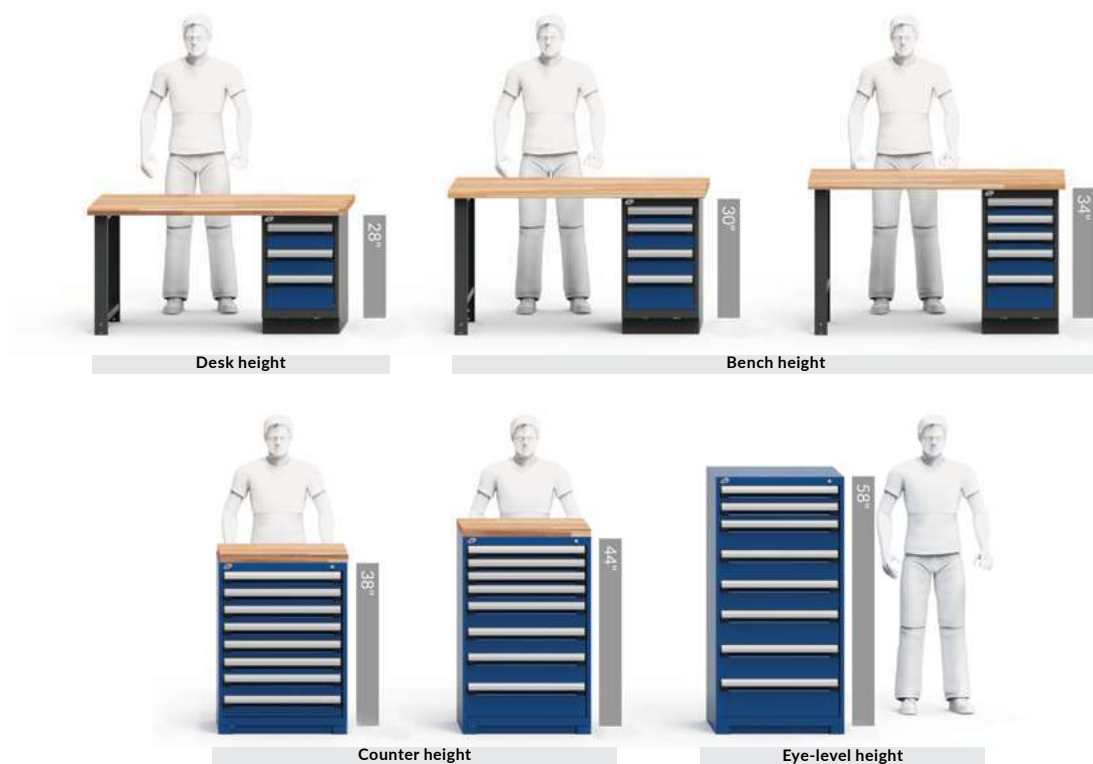

NOTE: The height specified excludes the base.

### WIDTH × DEPTH × HEIGHT

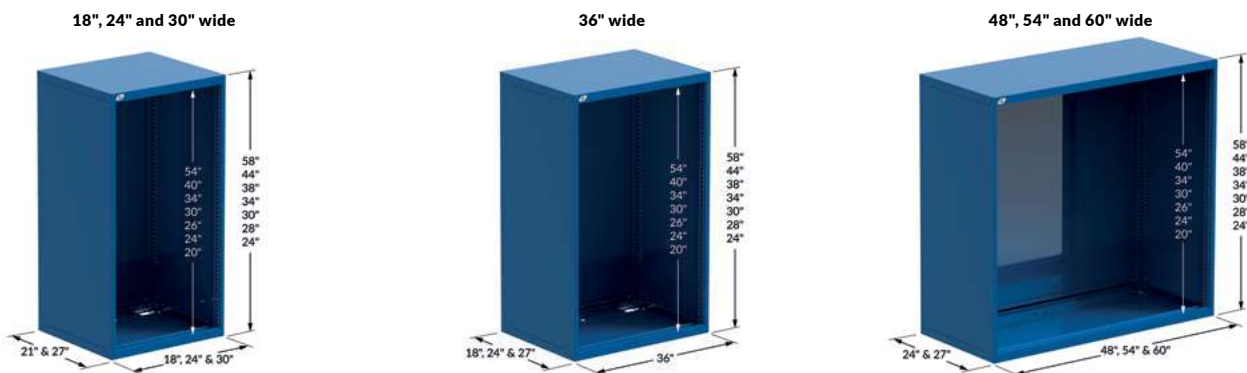

# PRECONFIGURED MODELS

HERE ARE SOME OF OUR MOST POPULAR PRECONFIGURED MODELS OF THE R HEAVY-DUTY STATIONARY CABINETS

- The preconfigured models in this section include a 2"H front-access forklift base and a lock on the cabinet housing (models with more than one drawer) and on the door
- The doors are factory installed with hinges on the right-hand side. They can be installed on the left upon request
- To add an L50 electronic lock to a door or to your R cabinet, [see page 11](#)



NOTE: For interior drawer dimensions, [see pages 226-228](#).

### IMPORTANT

Drawer compartments are included in all models. See the number of compartments and suggested layouts below.

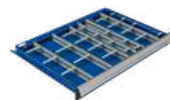

For drawers without compartments, replace the last two digits of the model number with the next even number up

e.g., R5ACD-2801 with R5ACD-2802 without



### NUMBER OF COMPARTMENTS (LAYOUT CODE)

DRAWER DIMENSIONS	3"H TO 5"H	6"H TO 8"H	9"H AND HIGHER
24"W x 21"D	12 (0308)	9 (0206)	4 (0102)
24"W x 27"D	20 (0316)	12 (0209)	6 (0104)
30"W x 21"D	24 (0518)	12 (0308)	6 (0203)
30"W x 27"D	25 (0420)	12 (0308)	9 (0206)
36"W x 18"D	24 (0518)	8 (0304)	6 (0203)
36"W x 24"D	30 (0524)	12 (0308)	9 (0206)
48"W x 24"D	40 (0732)	15 (0410)	8 (0304)
48"W x 27"D	32 (0724)	15 (0410)	8 (0304)
54"W x 24"D	40 (0930)	18 (0512)	10 (0405)
54"W x 27"D	40 (0930)	18 (0512)	10 (0405)
60"W x 24"D	70 (1356)	24 (0716)	12 (0308)
60"W x 27"D	84 (1370)	21 (0614)	12 (0308)

## 24" WIDE (W x D x H)



4 DRAWERS  
R5ACD-2801 24" x 21" x 30"  
R5ACG-2801 24" x 27" x 30"



4 DRAWERS  
R5ACD-2813 24" x 21" x 30"  
R5ACG-2813 24" x 27" x 30"



4 DRAWERS  
R5ACD-2805 24" x 21" x 30"  
R5ACG-2805 24" x 27" x 30"



6 DRAWERS  
R5ACD-3001 24" x 21" x 32"  
R5ACG-3001 24" x 27" x 32"



4 DRAWERS  
R5ACD-3005 24" x 21" x 32"  
R5ACG-3005 24" x 27" x 32"



1 DOOR /  
1 ADJUSTABLE SHELF /  
1 BOTTOM SHELF  
R5ACD-3009 24" x 21" x 32"  
R5ACG-3009 24" x 27" x 32"



3 DRAWERS  
R5ACD-3405 24" x 21" x 36"  
R5ACG-3405 24" x 27" x 36"



5 DRAWERS  
R5ACD-3403 24" x 21" x 36"  
R5ACG-3403 24" x 27" x 36"



9 DRAWERS  
R5ACD-3805 24" x 21" x 40"  
R5ACG-3805 24" x 27" x 40"



5 DRAWERS  
R5ACD-3807 24" x 21" x 40"  
R5ACG-3807 24" x 27" x 40"

## 30" WIDE (W x D x H)



5 DRAWERS  
R5ADD-2801 30" x 21" x 30"  
R5ADG-2801 30" x 27" x 30"



4 DRAWERS  
R5ADD-2803 30" x 21" x 30"  
R5ADG-2803 30" x 27" x 30"



5 DRAWERS  
R5ADD-2805 30" x 21" x 30"  
R5ADG-2805 30" x 27" x 30"



5 DRAWERS  
R5ADD-3003 30" x 21" x 32"  
R5ADG-3003 30" x 27" x 32"



6 DRAWERS  
R5ADD-3007 30" x 21" x 32"  
R5ADG-3007 30" x 27" x 32"



# PRECONFIGURED MODELS



1 DRAWER / 1 DOOR /  
1 BOTTOM SHELF  
R5ADD-3009 30" x 21" x 32"  
R5ADG-3009 30" x 27" x 32"



5 DRAWERS  
R5ADD-3815 30" x 21" x 40"  
R5ADG-3815 30" x 27" x 40"



7 DRAWERS  
R5ADD-3803 30" x 21" x 40"  
R5ADG-3803 30" x 27" x 40"



8 DRAWERS  
R5ADD-4401 30" x 21" x 46"  
R5ADG-4401 30" x 27" x 46"



5 DRAWERS  
R5ADD-4411 30" x 21" x 46"  
R5ADG-4411 30" x 27" x 46"



9 DRAWERS  
R5ADD-5805 30" x 21" x 60"  
R5ADG-5805 30" x 27" x 60"



9 DRAWERS  
R5ADD-5809 30" x 21" x 60"  
R5ADG-5809 30" x 27" x 60"



6 DRAWERS  
R5ADD-5843 30" x 21" x 60"  
R5ADG-5843 30" x 27" x 60"



9 DRAWERS  
R5ADD-5813 30" x 21" x 60"  
R5ADG-5813 30" x 27" x 60"



1 DOOR /  
1 BOTTOM SHELF / 5 DRAWERS  
R5ADD-5845 30" x 21" x 60"  
R5ADG-5845 30" x 27" x 60"

## 36" WIDE (W x D x H)



4 DRAWERS  
R5AEC-2801 36" x 18" x 30"  
R5AEE-2801 36" x 24" x 30"



4 DRAWERS  
R5AEC-2803 36" x 18" x 30"  
R5AEE-2803 36" x 24" x 30"



5 DRAWERS  
R5AEC-3005 36" x 18" x 32"  
R5AEE-3005 36" x 24" x 32"



2 DRAWERS  
R5AEC-3021 36" x 18" x 32"  
R5AEE-3021 36" x 24" x 32"



5 DRAWERS  
R5AEC-3805 36" x 18" x 40"  
R5AEE-3805 36" x 24" x 40"



5 DRAWERS  
R5AEC-3807 36" x 18" x 40"  
R5AEE-3807 36" x 24" x 40"



7 DRAWERS  
R5AEC-4403 36" x 18" x 46"  
R5AEE-4403 36" x 24" x 46"



11 DRAWERS  
R5AEC-4405 36" x 18" x 46"  
R5AEE-4405 36" x 24" x 46"



1 DOUBLE DOOR /  
1 ADJUSTABLE SHELF /  
1 BOTTOM SHELF  
R5AEC-4412 36" x 18" x 46"  
R5AEE-4412 36" x 24" x 46"



8 DRAWERS  
R5AEC-4415 36" x 18" x 46"  
R5AEE-4415 36" x 24" x 46"



11 DRAWERS  
R5AEC-5803 36" x 18" x 60"  
R5AEE-5803 36" x 24" x 60"



9 DRAWERS  
R5AEC-5813 36" x 18" x 60"  
R5AEE-5813 36" x 24" x 60"



6 DRAWERS  
R5AEC-5859 36" x 18" x 60"  
R5AEE-5859 36" x 24" x 60"



8 DRAWERS  
R5AEC-5825 36" x 18" x 60"  
R5AEE-5825 36" x 24" x 60"



7 DRAWERS  
R5AEC-5861 36" x 18" x 60"  
R5AEE-5861 36" x 24" x 60"

# PRECONFIGURED MODELS

## 48" WIDE (W x D x H)

R CABINET



5 DRAWERS		
R5AHE-3003	48" x 24" x 32"	
R5AHG-3003	48" x 27" x 32"	



7 DRAWERS		
R5AHE-3801	48" x 24" x 40"	
R5AHG-3801	48" x 27" x 40"	



1 SLIDING DOOR / 1 ADJUSTABLE SHELF / 1 BOTTOM SHELF		
R5AHE-3803	48" x 24" x 40"	
R5AHG-3803	48" x 27" x 40"	



5 DRAWERS		
R5AHE-3807	48" x 24" x 40"	
R5AHG-3807	48" x 27" x 40"	



9 DRAWERS		
R5AHE-4405	48" x 24" x 46"	
R5AHG-4405	48" x 27" x 46"	



7 DRAWERS		
R5AHE-4407	48" x 24" x 46"	
R5AHG-4407	48" x 27" x 46"	



1 DOUBLE DOOR / 1 ADJUSTABLE SHELF / 1 BOTTOM SHELF		
R5AHE-4414	48" x 24" x 46"	
R5AHG-4414	48" x 27" x 46"	



5 DRAWERS		
R5AHE-4427	48" x 24" x 46"	
R5AHG-4427	48" x 27" x 46"	



15 DRAWERS		
R5AHE-5805	48" x 24" x 60"	
R5AHG-5805	48" x 27" x 60"	



6 DRAWERS		
R5AHE-5807	48" x 24" x 60"	
R5AHG-5807	48" x 27" x 60"	



8 DRAWERS		
R5AHE-5809	48" x 24" x 60"	
R5AHG-5809	48" x 27" x 60"	



9 DRAWERS		
R5AHE-5813	48" x 24" x 60"	
R5AHG-5813	48" x 27" x 60"	



## 54" WIDE (W x D x H)



6 DRAWERS  
 R5AJE-3401 54" x 24" x 36"  
 R5AJG-3401 54" x 27" x 36"



7 DRAWERS  
 R5AJE-3403 54" x 24" x 36"  
 R5AJG-3403 54" x 27" x 36"



5 DRAWERS  
 R5AJE-3801 54" x 24" x 40"  
 R5AJG-3801 54" x 27" x 40"



6 DRAWERS  
 R5AJE-3803 54" x 24" x 40"  
 R5AJG-3803 54" x 27" x 40"



5 DRAWERS / 1 ROLL-OUT SHELF  
 R5AJE-4401 54" x 24" x 46"  
 R5AJG-4401 54" x 27" x 46"



5 DRAWERS  
 R5AJE-4405 54" x 24" x 46"  
 R5AJG-4405 54" x 27" x 46"



7 DRAWERS  
 R5AJE-4403 54" x 24" x 46"  
 R5AJG-4403 54" x 27" x 46"



1 DOUBLE DOOR /  
 3 ADJUSTABLE SHELVES /  
 1 BOTTOM SHELF  
 R5AJE-5802 54" x 24" x 60"  
 R5AJG-5802 54" x 27" x 60"



8 DRAWERS  
 R5AJE-5803 54" x 24" x 60"  
 R5AJG-5803 54" x 27" x 60"

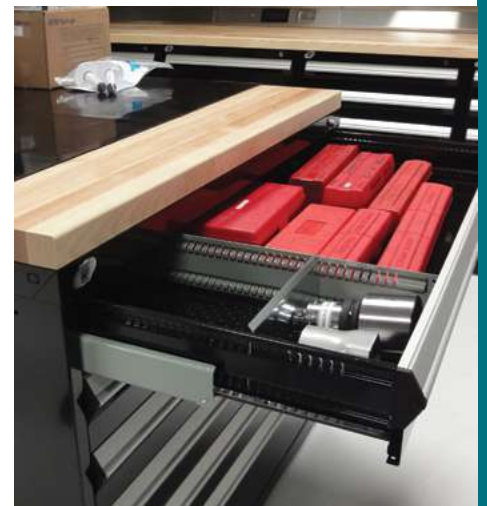

# PRECONFIGURED MODELS

## 60" WIDE (W x D x H)



5 DRAWERS  
 R5AKE-3805 60" x 24" x 40"  
 R5AKG-3805 60" x 27" x 40"



7 DRAWERS  
 R5AKE-3807 60" x 24" x 40"  
 R5AKG-3807 60" x 27" x 40"



6 DRAWERS  
 R5AKE-4401 60" x 24" x 46"  
 R5AKG-4401 60" x 27" x 46"



1 SLIDING DOOR /  
 2 ADJUSTABLE SHELVES /  
 1 BOTTOM SHELF  
 R5AKE-4406 60" x 24" x 46"  
 R5AKG-4406 60" x 27" x 46"



5 DRAWERS / 1 ROLL-OUT SHELF  
 R5AKE-5801 60" x 24" x 60"  
 R5AKG-5801 60" x 27" x 60"



9 DRAWERS  
 R5AKE-5803 60" x 24" x 60"  
 R5AKG-5803 60" x 27" x 60"



## SECURITY ACCESSORIES AND RECOMMENDATIONS

### VERTICAL SECURITY BAR RB10



- Locks all drawers in a cabinet with a padlock on the right (A) or left (B)
- Safety hasp is located at the top of the bar to facilitate access
- Covers a bank of drawers from 20"H to 54"H
- Allows full access to drawers even when installed against a wall
- More than one bar on the same cabinet can be installed (for different users)
- To order: Specify which side the bar is to be installed on, e.g., RB10-20LPA for the right-hand side

PRODUCT NO.	HEIGHT
RB10-20LP_	20"
RB10-24LP_	24"
RB10-26LP_	26"
RB10-30LP_	30"
RB10-34LP_	34"
RB10-40LP_	40"
RB10-54LP_	54"

NOTE: Vertical security bar A is not compatible with a drawer lock

### TRUE ONE-DRAWER-AT-A-TIME SYSTEM RB15



- Prevents multiple drawers from opening at the same time, which ensures the cabinet's stability and users' safety
- To order: Add A to the cabinet product number, e.g., RA30-302758A
- To retrofit this mechanism, order an RB15 and specify the number of drawers and roll-out shelves in the cabinet, e.g., RB15-58-07 for a cabinet with seven drawers
- One kit per cabinet

PRODUCT NO.	CABINET HEIGHT
RB15-28-__	28"
RB15-30-__	30"
RB15-34-__	34"
RB15-38-__	38"
RB15-44-__	44"
RB15-58-__	58"



Recommended for mobile cabinets and cabinets not anchored to the floor

### ELECTRONIC LOCK FOR CABINET WITH DRAWERS L50



- Electronically locks all drawers in the cabinet at the same time
- No key required
- Up to 20 different users can be programmed
- 4- to 8-digit access codes
- Simplifies access management to drawers
- To order the complete mechanism with a cabinet with drawers, order an RB00-DDHHL50
- To order as a replacement lock, order an HA62-L50



PRODUCT NO.  
L50

### SECURITY PANEL RF91



- Blocks access between two drawers with locks
- Usable space in the cabinet is reduced by 1"
- Installs between two drawers
- Divides the cabinet up for use by more than one user
- To order: Specify the width and depth required, e.g., RF91-3624 for a 36"W x 24"D panel

PRODUCT NO.  
RF91-\_\_ \_

### CENTRAL LOCKING SYSTEM L3



- Locks all drawers and roll-out shelves in the cabinet at the same time
- Drawer and roll-out shelf positions can be reconfigured
- Easy to retrofit
- To order: Add L3 to the cabinet product number, e.g., RA30-302758L3
- For replacement parts or to retrofit this mechanism, order an RB00-DDHHL3

PRODUCT NO.  
L3



### CABINET SAFETY HASP LP



- Locks all drawers and roll-out shelves in the cabinet at the same time
- Drawer and roll-out shelf positions can be reconfigured
- An alternative to an RB10 Vertical Security Bar
- Easy to retrofit
- To order: Add LP to the cabinet product number, e.g., RA30-302738LP
- For replacement parts or to retrofit this mechanism, order an RB00-DDHHLP

PRODUCT NO.  
LP

### ELECTRONIC LOCK FOR DOORS L50



- Electronically locks a cabinet door
- No key required
- Up to 20 different users can be programmed
- 4- to 8-digit access codes
- Compatible with single, double and polycarbonate swing doors, with or without frame (RB61, RB62, RB67, RB66, RB75 and RB76)
- To order: Add L50 to the door product code, e.g. RB61-3620L50



PRODUCT NO.  
L50

# ACCESSORIES

## CABINET TOPS

### STEEL TOP WITH RUBBER MAT

RC32



- ½"-thick non-slip neoprene surface
- Includes edges on the sides and back
- Height: 1"

### LAMINATED HARDWOOD TOP

WS14



- Top for general industrial applications
- Made from varnished hardwood slats
- Includes a 90° radius front edge for extra comfort
- High impact resistance
- Attractive appearance
- Thickness: 1¾"

### STAINLESS STEEL TOP

RC35



- 16ga stainless steel: RC35-WWDD
- 12ga stainless steel: RC35-WWDD-12
- Acts as a work surface and protects the cabinet from impacts
- Particle board top with stainless steel cover (#4 brushed finish)
- Excellent corrosion and chemical resistance
- Top complies with CARB regulations on formaldehyde emissions
- Includes welded corners for an attractive appearance
- Thickness: 1¾"
- To order a 12ga stainless steel top, add 12 to the product number

### MARINE EDGE STAINLESS STEEL TOP

RC35



- Marine edge 16ga stainless steel: RC35-WWDD-16M
- Marine edge 12ga stainless steel: RC35-WWDD-12M
- Prevents small objects or liquids from falling or spilling from the work surface
- Acts as a work surface and protects the cabinet from impacts
- Particle board top with stainless steel cover (#4 brushed finish)
- Excellent corrosion and chemical resistance
- Top complies with CARB regulations on formaldehyde emissions
- Includes welded corners for an attractive appearance
- Thickness: 1¾"
- To order: Specify the steel gauge required, e.g., RC35-WWDD-16M for a marine edge 16ga stainless steel top

### PAINTED STEEL TOP

RC37



- Acts as a work surface and protects the cabinet from impacts
- Particle board top with painted steel cover
- Top complies with CARB regulations on formaldehyde emissions
- Includes welded corners for an attractive appearance
- Thickness: 1¾"



DIMENSIONS		TYPE OF TOP				
W	D	STEEL TOP WITH RUBBER MAT	LAMINATED HARDWOOD TOP*	STAINLESS STEEL TOP	MARINE EDGE STAINLESS STEEL TOP*	PAINTED STEEL TOP
18"	21"	RC32-1821-01	WS14-1821A	RC35-1821-__**		RC37-1821
	27"	RC32-1827-01	WS14-1827A	RC35-1827-__**		RC37-1827
24"	21"	RC32-2421-01	WS14-2421A	RC35-2421-__**		RC37-2421
	27"	RC32-2427-01	WS14-2427A	RC35-2427-__		RC37-2427
30"	21"	RC32-3021-01	WS14-3021A	RC35-3021-__**		RC37-3021
	24"	RC32-3024-01	WS14-3027A	RC35-3024-__**		RC37-3024
	27"	RC32-3027-01	WS14-3027A	RC35-3027-__	RC35-3027-__M	RC37-3027
	30"	RC32-3030-01	WS14-3030A	RC35-3030-__	RC35-3030-__M	RC37-3030
36"	18"	RC32-3618-01	WS14-3618A			RC37-3618
	21"	RC32-3621-01	WS14-3621A	RC35-3621-__**		RC37-3621
	24"	RC32-3624-01	WS14-3624A	RC35-3624-__	RC35-3624-__M	RC37-3624
	27"	RC32-3627-01	WS14-3627A	RC35-3627-__	RC35-3627-__M	RC37-3627
	30"	RC32-3630-01	WS14-3630A	RC35-3630-__	RC35-3630-__M	RC37-3630
48"	24"	RC32-4824-01	WS14-4824A	RC35-4824-__	RC35-4824-__M	RC37-4824
	27"	RC32-4827-01	WS14-4827A	RC35-4827-__	RC35-4827-__M	RC37-4827
	30"	RC32-4830-01	WS14-4830A	RC35-4830-__	RC35-4830-__M	RC37-4830
54"	24"	RC32-5424-01	WS14-5424A	RC35-5424-__	RC35-5424-__M	RC37-5424
	27"	RC32-5427-01	WS14-5427A	RC35-5427-__	RC35-5427-__M	RC37-5427
	30"	RC32-5430-01	WS14-5430A	RC35-5430-__	RC35-5430-__M	RC37-5430
60"	24"	RC32-6024-01	WS14-6024A	RC35-6024-__	RC35-6024-__M	RC37-6024
	27"	RC32-6027-01	WS14-6027A	RC35-6027-__	RC35-6027-__M	RC37-6027
	30"	RC32-6030-01	WS14-6030A	RC35-6030-__	RC35-6030-__M	RC37-6030
72"	24"	RC32-7224-01	WS14-7224A	RC35-7224-__	RC35-7224-__M	RC37-7224
	27"	RC32-7227-01	WS14-7227A	RC35-7227-__	RC35-7227-__M	RC37-7227
	30"	RC32-7230-01	WS14-7230A	RC35-7230-__	RC35-7230-__M	RC37-7230

NOTES: \* Please check with your Customer Service representative for lead times.

\*\* 16ga only

For compatibility with doors with frame, choose a top 3" deeper than your cabinet, e.g., 27"D cabinet + door with 3"D frame = 30"D top

## SLOPED TOP

## RC30

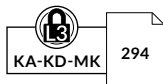

- The 30° sloped surface opens so documents and other items can be stored inside
- Compatible with a ½" dia. articulated lamp
- Load capacity: 100lb. (evenly distributed)
- For compatibility with doors with frame, choose a top 3" deeper than your cabinet, e.g., 27"D cabinet + door with 3"D frame = 30"D top
- Standard lock included

PRODUCT NO.	W x D x H	COMPATIBLE DIVIDER
RC30-242708L3	24" x 27" x 8"	SH52-1506
RC30-302708L3	30" x 27" x 8"	SH52-1506
RC30-303008L3	30" x 30" x 8"	SH52-1806
RC30-362408L3	36" x 24" x 8"	SH52-1206
RC30-362708L3	36" x 27" x 8"	SH52-1506
RC30-363008L3	36" x 30" x 8"	SH52-1806
RC30-482408L3	48" x 24" x 8"	SH52-1206
RC30-482708L3	48" x 27" x 8"	SH52-1506
RC30-483008L3	48" x 30" x 8"	SH52-1806

## PARTIAL DIVIDER

## SH52



- Unique patented design for easy position changes
- Height: 5½"
- Easy tool-free installation

### Dimensions for sloped tops

PRODUCT NO.	ACTUAL DEPTH	FOR RC30
SH52-1206	7½"	24" Deep
SH52-1506	10½"	27" Deep
SH52-1806	13½"	30" Deep

### Dimensions for RB shelves

PRODUCT NO.	ACTUAL DEPTH	FOR SHELVES
SH52-1506	10½"	18" Deep
SH52-1806	13½"	21" Deep
SH52-2106	16½"	24" Deep
SH52-2406	19½"	27" Deep

Includes pictograms for easy installation

NOTE: Requires a minimum space of 8" between shelves.

# ACCESSORIES

## BACK OR SIDE STOP

WS18 / WS98



- Painted steel: WS18
- Stainless steel: WS98
- Can be installed on back or sides depending on top dimensions
- Installs on WS14 and RC37 tops
- Height: 5"
- Clears top by approx. 3 1/4"
- To order: Add the type of steel required to the product number

PRODUCT NO.	LENGTH
WS__-1805	18"
WS__-2405	24"
WS__-2705	27"
WS__-3005	30"
WS__-3605	36"
WS__-4805	48"
WS__-5405	54"
WS__-6005	60"
WS__-7205	72"

NOTE: Not compatible with RC32 and RC35 tops.



## STACKING CABINETS

### STACKING CABINETS



- One shelf, adjustable in 1" increments c/c
- One bottom shelf
- Standard lock included on each door
- Heights available: 24", 30" and 34"
- Includes hardware kit for stacking
- To order: Specify the cabinet height and door type required according to the chart, e.g., R5HEE-2403 for a 36"W x 24"D x 24"H cabinet with double integrated doors

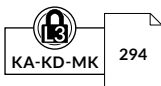

PRODUCT NO.	W x D
R5HBD-___	18" x 21"
R5HBG-___	18" x 27"
R5HCD-___	24" x 21"
R5HCG-___	24" x 27"
R5HDD-___	30" x 21"
R5HDG-___	30" x 27"
R5HEC-___	36" x 18"
R5HEE-___	36" x 24"

PRODUCT NO.	W x D
R5HEG-___	36" x 27"
R5HHE-___	48" x 24"
R5HHG-___	48" x 27"
R5HJE-___	54" x 24"
R5HJG-___	54" x 27"
R5HKE-___	60" x 24"
R5HKG-___	60" x 27"



R5XHE-1002

DOOR REQUIRED	CABINET WIDTH				
	18" & 24"	30" & 36"	48"	54"	60"
00 Without door	X	X	X	X	X
01 Single integrated door	X	X			
02 Single integrated polycarbonate door	X	X			
03 Double integrated doors		X	X	X	X
04 Double integrated polycarbonate doors		X	X	X	X
05 Double doors with frame		X	X	X	X
06 Double polycarbonate doors with frame		X	X	X	X
07 Integrated sliding doors			X	X	X
08 Integrated sliding polycarbonate doors			X	X	X
09 Sliding doors with frame			X		X
10 Sliding polycarbonate doors with frame			X		X





## POWER FEED PANELS AND COVER PANELS

PANEL	FINISH	
	PAINTED STEEL	STAINLESS STEEL
Power feed	RC64	RC65
Finishing	RC66	RC67
Finishing panel for computer mount	RC68	RC69

BACK PANEL	PRODUCT NO.	ENDS WITH
Without	01	
With	02	

### POWER FEED PANEL



- Painted steel: RC64
- Stainless steel: RC65
- Includes a power bar with three 12A outlets for a 15A circuit
- Three additional versions available: with a knockout for a pneumatic connection and a perforation (with a cover plate) for a telephone/Ethernet jack; or with two USB ports; or with knockout, perforation and two USB ports
- Installs on RC35, RC37, WS08, WS14 and WS16 tops only
- To order: Specify the panel width required: 30", 36", 48", 54", 60", 72" e.g., RC64-301001 for a 30"W panel
- To order: Specify with or without a back finishing panel: Without: 01 With: 02 e.g., RC64-301001 without back finishing panel

PRODUCT NO.	OPTIONS
RC64-__10__	3 power outlets (12A)
RC64-__11__	3 power outlets (12A) and perforation
RC64-__12__	3 power outlets (12A), 2 USB ports (1 A, 1 C)
RC64-__13__	3 power outlets (12A), 2 USB ports (1 A, 1 C), knockout and perforation
RC65-__10__	3 power outlets (12A)
RC65-__11__	3 power outlets (12A) and perforation
RC65-__12__	3 power outlets (12A), 2 USB ports (1 A, 1 C)
RC65-__13__	3 power outlets (12A), 2 USB ports (1 A, 1 C), knockout and perforation



Pneumatic connection



USB ports



Phone/Ethernet jacks



R5XHG-1056

### COVER PANEL FOR COMPUTER MOUNT

RC68 / RC69



- Painted steel: RC68
- Stainless steel: RC69
- Can be combined with a power feed panel or a cover panel on the same workstation or cabinet
- To order: Specify the type of finish required, e.g., RC68-2401 for painted steel
- Available with or without a back finishing panel
- Installs on RC35, RC37, WS08, WS14 and WS16 tops only
- Includes a perforation in the middle for installation of RC59 computer mounts

PRODUCT NO.	WIDTH	WITH OR WITHOUT BACK PANEL
RC__-1801	18"	Without back panel
RC__-1802	18"	With back panel
RC__-2401	24"	Without back panel
RC__-2402	24"	With back panel

### COVER PANEL

RC66 / RC67



- Painted steel: RC66
- Stainless steel: RC67
- Can be combined with a power feed panel or a cover panel, on the same workstation or cabinet
- Available with or without a back finishing panel
- Installs on RC35, RC37, WS08, WS14 and WS16 tops only
- To order: Specify the type of finish required, e.g., RC66-3001 for painted steel

PRODUCT NO.	WIDTH	WITH OR WITHOUT BACK PANEL
RC__-1801	18"	Without back panel
RC__-1802	18"	With back panel
RC__-2401	24"	Without back panel
RC__-2402	24"	With back panel
RC__-3001	30"	Without back panel
RC__-3002	30"	With back panel
RC__-3601	36"	Without back panel
RC__-3602	36"	With back panel
RC__-4801	48"	Without back panel
RC__-4802	48"	With back panel
RC__-5401	54"	Without back panel
RC__-5402	54"	With back panel
RC__-6001	60"	Without back panel
RC__-6002	60"	With back panel
RC__-7201	72"	Without back panel
RC__-7202	72"	With back panel

# ACCESSORIES

## COMPUTER MOUNTS

All models featured here have the following characteristics:

- Installs on the work surface with an RC68 or RC69 cover panel for computer mounts
- Compatible with the following work surfaces: WS08, WS14, WS16, RC35 and RC37
- Includes an 18"H pole for height adjustment to suit each user

### LCD MONITOR ARM



- Supports most LCD monitors on the market (max. 21")
- Includes one or two arms with two-section articulation
- Complies with VESA 75 and 100 monitor mounting standards
- The two-section articulating arm allows for increased adjustability
- The screen can also be tilted for better ergonomics
- One or two arms can be ordered

PRODUCT NO.	FOR
RC59-03	Single screen
RC59-04	Two screens

### LCD MONITOR, KEYBOARD & MOUSE MOUNT



- Holds a computer monitor, keyboard and mouse
- Tray's usable area: 23 $\frac{5}{8}$ "W  $\times$  8 $\frac{1}{2}$ "D
- Includes an articulating arm and mount for a keyboard, and mount for a screen
- Complies with VESA 75 and 100 monitor mounting standards
- Supports most LCD monitors on the market (max. 21")
- The tray and screen can also be tilted for better ergonomics

PRODUCT NO.
RC59-21

- The work surface must extend beyond the rear by 1 $\frac{1}{2}$ "
- Articulating arms, adapters and trays are painted black
- Does not install directly on the housing

### LAPTOP ARM



- Holds a laptop computer, papers, binders or any other object
- Tray's usable area: 14"W  $\times$  12"D
- Includes a two-section articulating arm and a tray
- The two-section articulating arm allows for increased adjustability
- The tray can also be tilted for better ergonomics

PRODUCT NO.
RC59-42

### TABLET ARM



- Supports most tablets on the market
- Includes a two-section articulating arm and a tablet mount
- The clamps and mount have a non-slip surface to keep the tablet stable
- The two-section articulating arm allows for increased adjustability
- The mount can also be tilted for better ergonomics
- Compatible tablet sizes:
  - Small: 7 $\frac{5}{8}$ "W to 10"W
  - Large: 9 $\frac{7}{8}$ "W to 12 $\frac{1}{4}$ "W

PRODUCT NO.	FOR
RC59-62-01	Small
RC59-62-02	Large



## SIDE PANELS

### SIDE UTILITY PANEL

RC02

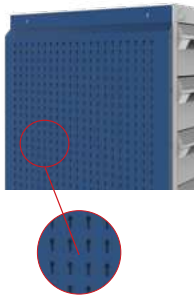

- 5S storage accessory
- Maximizes the cabinet's storage space
- Installs on the sides of R cabinets
- Quick and easy installation
- Includes perforations spaced 1" apart c/c for hanging a range of hooks
- Load capacity: 50lb./sq. ft., 500lb. max. per panel
- Compatible with WM9F, WM9G, WM9H, WM9J and WM9L light-duty hooks, and WM9A and WM9B heavy-duty hooks
- Compatible with WM9Q tool holders, WM9C bin rails, WM9D can holders, WM9M and WM9N hooks, WM9P spool and roll holders, and WM21 shelves
- Available in all standard R cabinet dimensions (depth, height)
- To order: Specify the housing height required, e.g., RC02-2434 for a 24"D x 34"H housing

PRODUCT NO.	CABINET DEPTH	NO. OF HOLES
RC02-18 __	18"	15
RC02-21 __	21"	18
RC02-24 __	24"	21
RC02-27 __	27"	24

NOTE: Full height installation only.

### SIDE PANEL FOR PLASTIC BINS

RC04

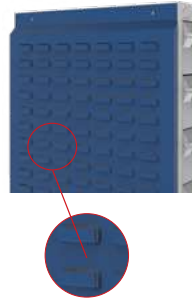

- 5S storage accessory
- Maximizes the cabinet's storage space
- Installs on the sides of R cabinets
- Quick and easy installation
- Holds RG20 plastic bins
- Compatible with all commercially available brands of plastic bins with a hanging lip
- Available in all standard R cabinet dimensions (depth, height)
- To order: Specify the housing height required: RC04-2434 for a 24"D x 34"H housing

PRODUCT NO.	CABINET DEPTH
RC04-18 __	18"
RC04-21 __	21"
RC04-24 __	24"
RC04-27 __	27"

NOTE: Full height installation only.

## ESD PROTECTION

### ESD CABINET

RC50



- Special paint dissipates electric charges (Black 090)
- Includes a grounding cord with 1MΩ resistance and a socket for a grounding wrist strap
- To order a cabinet with ESD protection, please order an RC50-01 grounding kit and specify dissipative paint color Black 090

PRODUCT NO.  
RC50-01



NOTE: Contact Customer Service for ESD paint prices.

### GROUNDING WRIST STRAP



- Made of stretch fabric
- Includes a 6' cord with 1MΩ resistance
- Dissipates electric charges that can damage electronic components

PRODUCT NO.  
70000320

### CONDUCTIVE PLASTIC BINS



245

### DISSIPATIVE TOP



144

## WASTE & RECYCLING CABINETS AND SINK CABINET

### WASTE & RECYCLING CABINET



- Can be used as a standalone unit, as part of a cabinet configuration (e.g., counter cabinets) or integrated underneath a work surface
- Used for sorting waste and items for recycling
- Includes one 26"H drawer with labeled drawer handle to facilitate sorting

- Includes two 15¼"W × 11"D × 20"H containers: a black container for waste (RK09-02) and a blue container for recycling (RK09-01)
- The drawer includes a divider which secures the containers and also allows items to be stored behind

PRODUCT NO.	W × D × H
R5XCG-1100	24" × 27" × 30"
R5XDG-1100	30" × 27" × 30"

### WASTE & RECYCLING DRAWER



- Used for sorting waste and items for recycling
- Includes a labeled drawer handle to facilitate sorting
- Drawer heights available: 17" and 26"
- The 17"H drawer includes two 14¾"W × 10¼"D × 15"H containers: a black container for waste and a blue container for recycling
- The 26"H drawer includes two 15¼"W × 11"D × 20"H containers: a black container for waste and a blue container for recycling

- The drawer includes a divider which secures the containers and also allows items to be stored behind
- To add a locking or security mechanism, complete the product number with the locking mechanism product number required, e.g., R51CG-X1701A to add an integrated lock-in mechanism

PRODUCT NO.	W × D × H
R51CG-X1701_	24" × 27" × 17"
R51CG-X2601_	24" × 27" × 26"
R51DG-X1701_	30" × 27" × 17"
R51DG-X2601_	30" × 27" × 26"

NOTE: The drawer is also available separately; see RF53 for a painted steel front and RF54 for a stainless steel front

### SINK CABINET



- The top is open to allow for installation of a sink
- Includes an opening on the back of the housing to allow for installation of a drain and pipes
- One bottom shelf
- Models with a door with frame are compatible with drawers and roll-out shelves
- Standard lock included on each door
- Compatible with bases, [see page 20](#)

- Heights available: 28", 30" and 34"
- To order: Specify the cabinet height and door type required according to the chart below, e.g., R5TDD-28 01

PRODUCT NO.	W × D	DOOR REQUIRED
R5TCD-___*	24" × 21"	01 Single integrated door
R5TCG-___*	24" × 27"	02 Double integrated doors
R5TDD-___**	30" × 21"	03 Double doors with frame
R5TDG-___**	30" × 27"	04 Integrated sliding doors
R5THD-___	48" × 21"	05 Sliding doors with frame
R5THG-___	48" × 27"	

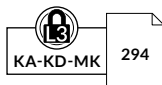

NOTES: \*\* Available with single door only

\*\* These models are not compatible with sliding doors

Work surfaces must be ordered separately (work surface cutting is not provided by Rousseau), [see page 12 and 144](#).

Sink not included.



R5XTG-3002

HOUSINGS

R HEAVY-DUTY CABINET HOUSING

RA30

- Compatible with modular drawers, roll-out shelves, adjustable shelves and bottom shelves
- Compatible with integrated doors and doors with frame
- The housing units include knockouts
  - on the top for stacking cabinets and installing accessories or work surfaces
  - on the sides and back for anchoring cabinets side by side or back to back and for attaching accessories
- Includes a concrete-floor anchoring kit for cabinet housings and bases, and hardware for stacking cabinets

- A cabinet lock allows users to lock all drawers and roll-out shelves in the cabinet at the same time. To order, add **L3** to the product number, [see page 11](#);
- To order a safety hasp, add **LP** to the product number, [see page 11](#)
- For factory installation of an electronic lock, order a **RB00-DDHHL50**, [see page 11](#);
- To order a true One-Drawer-at-a-Time mechanism, add **A** to the product number

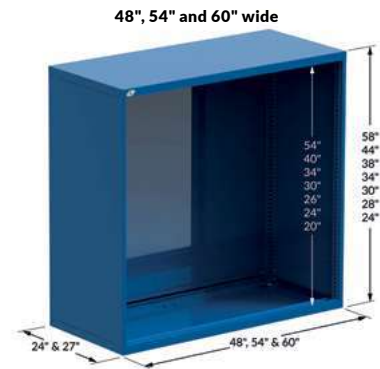
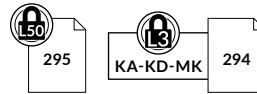

PRODUCT NO.	TOTAL HEIGHT	INSIDE HEIGHT
<b>18" x 21"</b>		
RA30-182124__	24"	20"
RA30-182128__	28"	24"
RA30-182130__	30"	26"
RA30-182134__	34"	30"
RA30-182138__	38"	34"
RA30-182144__	44"	40"
RA30-182158__	58"	54"
<b>18" x 27"</b>		
RA30-182724__	24"	20"
RA30-182728__	28"	24"
RA30-182730__	30"	26"
RA30-182734__	34"	30"
RA30-182738__	38"	34"
RA30-182744__	44"	40"
RA30-182758__	58"	54"
<b>24" x 21"</b>		
RA30-242124__	24"	20"
RA30-242128__	28"	24"
RA30-242130__	30"	26"
RA30-242134__	34"	30"
RA30-242138__	38"	34"
RA30-242144__	44"	40"
RA30-242158__	58"	54"
<b>24" x 27"</b>		
RA30-242724__	24"	20"
RA30-242728__	28"	24"
RA30-242730__	30"	26"
RA30-242734__	34"	30"
RA30-242738__	38"	34"
RA30-242744__	44"	40"
RA30-242758__	58"	54"

PRODUCT NO.	TOTAL HEIGHT	INSIDE HEIGHT
<b>30" x 21"</b>		
RA30-302124__	24"	20"
RA30-302128__	28"	24"
RA30-302130__	30"	26"
RA30-302134__	34"	30"
RA30-302138__	38"	34"
RA30-302144__	44"	40"
RA30-302158__	58"	54"
<b>30" x 27"</b>		
RA30-302724__	24"	20"
RA30-302728__	28"	24"
RA30-302730__	30"	26"
RA30-302734__	34"	30"
RA30-302738__	38"	34"
RA30-302744__	44"	40"
RA30-302758__	58"	54"
<b>36" x 18"</b>		
RA30-361824__	24"	20"
RA30-361828__	28"	24"
RA30-361830__	30"	26"
RA30-361834__	34"	30"
RA30-361838__	38"	34"
RA30-361844__	44"	40"
RA30-361858__	58"	54"
<b>36" x 24"</b>		
RA30-362424__	24"	20"
RA30-362428__	28"	24"
RA30-362430__	30"	26"
RA30-362434__	34"	30"
RA30-362438__	38"	34"
RA30-362444__	44"	40"
RA30-362458__	58"	54"

PRODUCT NO.	TOTAL HEIGHT	INSIDE HEIGHT
<b>36" x 27"</b>		
RA30-362724__	24"	20"
RA30-362728__	28"	24"
RA30-362730__	30"	26"
RA30-362734__	34"	30"
RA30-362738__	38"	34"
RA30-362744__	44"	40"
RA30-362758__	58"	54"
<b>48" x 24"</b>		
RA30-482424__	24"	20"
RA30-482428__	28"	24"
RA30-482430__	30"	26"
RA30-482434__	34"	30"
RA30-482438__	38"	34"
RA30-482444__	44"	40"
RA30-482458__	58"	54"
<b>48" x 27"</b>		
RA30-482724__	24"	20"
RA30-482728__	28"	24"
RA30-482730__	30"	26"
RA30-482734__	34"	30"
RA30-482738__	38"	34"
RA30-482744__	44"	40"
RA30-482758__	58"	54"
<b>54" x 24"</b>		
RA30-542424__	24"	20"
RA30-542428__	28"	24"
RA30-542430__	30"	26"
RA30-542434__	34"	30"
RA30-542438__	38"	34"
RA30-542444__	44"	40"
RA30-542458__	58"	54"

PRODUCT NO.	TOTAL HEIGHT	INSIDE HEIGHT
<b>54" x 27"</b>		
RA30-542724__	24"	20"
RA30-542728__	28"	24"
RA30-542730__	30"	26"
RA30-542734__	34"	30"
RA30-542738__	38"	34"
RA30-542744__	44"	40"
RA30-542758__	58"	54"
<b>60" x 24"</b>		
RA30-602424__	24"	20"
RA30-602428__	28"	24"
RA30-602430__	30"	26"
RA30-602434__	34"	30"
RA30-602438__	38"	34"
RA30-602444__	44"	40"
RA30-602458__	58"	54"
<b>60" x 27"</b>		
RA30-602724__	24"	20"
RA30-602728__	28"	24"
RA30-602730__	30"	26"
RA30-602734__	34"	30"
RA30-602738__	38"	34"
RA30-602744__	44"	40"
RA30-602758__	58"	54"

## BASES

### FRONT ACCESS FORKLIFT BASE RA52



- 2"H base used for moving the cabinet from the front with a forklift
- Includes a front kick plate
- Front kick plate is recessed to allow users to stand closer to the cabinet
- Designed so the cabinet can be anchored to the floor
- Compatible with RA74 Leveling Glide Kit
- Compatible with an optional RA54 Angled Kick Plate

PRODUCT NO.	W × D
RA52-182102	18" × 21"
RA52-182702	18" × 27"
RA52-242102	24" × 21"
RA52-242702	24" × 27"
RA52-302102	30" × 21"
RA52-302702	30" × 27"
RA52-361802	36" × 18"
RA52-362402	36" × 24"

PRODUCT NO.	W × D
RA52-362702	36" × 27"
RA52-482402	48" × 24"
RA52-482702	48" × 27"
RA52-542402	54" × 24"
RA52-542702	54" × 27"
RA52-602402	60" × 24"
RA52-602702	60" × 27"

NOTES: Not compatible with casters  
Not to be used for stacking cabinets

### FRONT AND SIDE ACCESS FORKLIFT BASE RA53



- 4"H base used for moving the cabinet from the front or side with a forklift, or from the front with a pallet-jack
- Includes a front kick plate
- Includes a recessed kick plate in the center to allow users to stand closer to the cabinet
- Designed so the cabinet can be anchored to the floor
- Compatible with RA74 Leveling Glide Kit
- Compatible with an optional RA54 Angled Kick Plate

PRODUCT NO.	W × D
RA53-182104	18" × 21"
RA53-182704	18" × 27"
RA53-242104	24" × 21"
RA53-242704	24" × 27"
RA53-302104	30" × 21"
RA53-302704	30" × 27"
RA53-361804	36" × 18"
RA53-362404	36" × 24"

PRODUCT NO.	W × D
RA53-362704	36" × 27"
RA53-482404	48" × 24"
RA53-482704	48" × 27"
RA53-542404	54" × 24"
RA53-542704	54" × 27"
RA53-602404	60" × 24"
RA53-602704	60" × 27"

NOTES: Not compatible with casters  
Not to be used for stacking cabinets

### ANGLED KICK PLATE RA54



- Closes off the back of 2"H and 4"H forklift bases (RA52 and RA53)

PRODUCT NO.	W × H
RA54-1802	18" × 2"
RA54-1804	18" × 4"
RA54-2402	24" × 2"
RA54-2404	24" × 4"
RA54-3002	30" × 2"
RA54-3004	30" × 4"
RA54-3602	36" × 2"
RA54-3604	36" × 4"
RA54-4802	48" × 2"
RA54-4804	48" × 4"
RA54-5402	54" × 2"
RA54-5404	54" × 4"
RA54-6002	60" × 2"
RA54-6004	60" × 4"

### RECESSED BASE RA55 / RA57



- Painted steel: RA55
- Stainless steel: RA57
- Raises the height of a cabinet by 2" or 4"
- Includes a removable kick plate at the front for a neater finish
- The front kick plate is on a straight angle for easier floor cleaning
- Creates a 2" recessed space to allow users to stand closer to the cabinet
- Designed so the cabinet can be anchored to the floor
- Compatible with an optional RA56 or RA58 Straight Kick Plate
- Compatible with RA74 Leveling Glide Kit
- To order: Add the type of steel required to the product number e.g., RA57-302702 for 30"W × 27"D × 2"H stainless steel base
- For a replacement front kick plate, order an RY75-LLHH (painted steel) or RY77-WVHH (stainless steel).

PRODUCT NO.	W × D × H
RA__-182102	18" × 21" × 2"
RA__-182104	18" × 21" × 4"
RA__-182702	18" × 27" × 2"
RA__-182704	18" × 27" × 4"
RA__-242102	24" × 21" × 2"
RA__-242104	24" × 21" × 4"
RA__-242702	24" × 27" × 2"
RA__-242704	24" × 27" × 4"
RA__-302102	30" × 21" × 2"
RA__-302104	30" × 21" × 4"
RA__-302702	30" × 27" × 2"
RA__-302704	30" × 27" × 4"
RA__-361802	36" × 18" × 2"
RA__-361804	36" × 18" × 4"
RA__-362402	36" × 24" × 2"
RA__-362404	36" × 24" × 4"
RA__-362702	36" × 27" × 2"
RA__-362704	36" × 27" × 4"

PRODUCT NO.	W × D × H
RA__-482402	48" × 24" × 2"
RA__-482404	48" × 24" × 4"
RA__-482702	48" × 27" × 2"
RA__-482704	48" × 27" × 4"
RA__-542402	54" × 24" × 2"
RA__-542404	54" × 24" × 4"
RA__-542702	54" × 27" × 2"
RA__-542704	54" × 27" × 4"
RA__-602402	60" × 24" × 2"
RA__-602404	60" × 24" × 4"
RA__-602702	60" × 27" × 2"
RA__-602704	60" × 27" × 4"

NOTES: Not compatible with casters  
Not to be used for stacking cabinet

## STRAIGHT KICK PLATE

RA56 / RA58



- Painted steel: RA56
- Stainless steel: RA58
- Closes off the back of 2"H and 4"H recessed bases (RA55 and RA57)
- To order: Add the type of steel required to the product number, e.g., RA58-4804 for a 48"W x 4"H stainless steel straight kick plate

PRODUCT NO.	W x H
RA__-1802	18" x 2"
RA__-1804	18" x 4"
RA__-2402	24" x 2"
RA__-2404	24" x 4"
RA__-3002	30" x 2"
RA__-3004	30" x 4"
RA__-3602	36" x 2"
RA__-3604	36" x 4"
RA__-4802	48" x 2"
RA__-4804	48" x 4"
RA__-5402	54" x 2"
RA__-5404	54" x 4"
RA__-6002	60" x 2"
RA__-6004	60" x 4"

## LEVELING GLIDE KIT

RA74



- Sold in kits of 4
- Adjusts the height of cabinets 1 1/8" to 2" on uneven floor surfaces

PRODUCT NO.  
RA74-01

## SHIM PLATE

RA80



- Sold individually
- Levels cabinets on uneven surfaces
- Compatible with floor anchoring kits
- 12ga galvanized steel

PRODUCT NO. THICKNESS:  
RA80-12 12 gauge (0,100)

## DRAWERS, SHELVES AND LOCKING / SECURITY MECHANISMS

### HEAVY-DUTY MODULAR DRAWER



RF31 / RF35



- Painted steel drawer: RF31
- Drawer with stainless steel front and gray painted steel interior: RF35
- 400lb. load capacity, 100% extension
- Heavy-duty construction
- Easy to install
- Vast choice of accessories available to customize the drawer to your storage needs, [see pages 242-247](#)
- Drawer heights available: 3", 4", 5", 6", 7", 8", 9", 10", 12" and 14"
- To order: Add the drawer height to the product number and specify the type of drawer front required (painted steel or stainless steel), e.g., RF31-362406
- For preconfigured modular drawers with compartments, [see pages 224-241](#)

PRODUCT NO.	W x D
RF__-1821__	18" x 21"
RF__-1827__	18" x 27"
RF__-2421__	24" x 21"
RF__-2427__	24" x 27"
RF__-3021__	30" x 21"
RF__-3027__	30" x 27"
RF__-3618__	36" x 18"
RF__-3624__	36" x 24"
RF__-3627__	36" x 27"
RF__-4824__	48" x 24"
RF__-4827__	48" x 27"
RF__-5424__	54" x 24"
RF__-5427__	54" x 27"
RF__-6024__	60" x 24"
RF__-6027__	60" x 27"

### HEAVY-DUTY FRONT ACCESS ROLL-OUT SHELF



RF40



- 400lb. load capacity, 100% extension
- Heavy-duty construction
- Easy to install
- Painted steel with 3"H edges on the sides and back
- Total height: 6"
- Full access to contents

PRODUCT NO.	W x D	PRODUCT NO.	W x D
RF40-1821	18" x 21"	RF40-4824	48" x 24"
RF40-1827	18" x 27"	RF40-4827	48" x 27"
RF40-2421	24" x 21"	RF40-5424	54" x 24"
RF40-2427	24" x 27"	RF40-5427	54" x 27"
RF40-3021	30" x 21"	RF40-6024	60" x 24"
RF40-3027	30" x 27"	RF40-6027	60" x 27"
RF40-3618	36" x 18"		
RF40-3624	36" x 24"		
RF40-3627	36" x 27"		

### HEAVY-DUTY 3-SIDED ACCESS ROLL-OUT SHELF



RF44



- 400lb. load capacity, 100% extension
- Heavy-duty construction
- Easy to install
- Galvanized steel shelf with 1 1/2"H edge at the back
- Total height: 5"
- Can be used as a work surface

PRODUCT NO.	W x D	PRODUCT NO.	W x D
RF44-1821	18" x 21"	RF44-4824	48" x 24"
RF44-1827	18" x 27"	RF44-4827	48" x 27"
RF44-2421	24" x 21"	RF44-5424	54" x 24"
RF44-2427	24" x 27"	RF44-5427	54" x 27"
RF44-3021	30" x 21"	RF44-6024	60" x 24"
RF44-3027	30" x 27"	RF44-6027	60" x 27"
RF44-3618	36" x 18"		
RF44-3624	36" x 24"		
RF44-3627	36" x 27"		

## INTEGRATED LOCK-IN MECHANISM

A



- Automatically activated when lifting the handle up
- The drawer or roll-out shelf can be opened with one hand only
- Closes with a simple push
- Stops drawer or roll-out shelf from opening on their own
- Easy to retrofit
- To order: Add "A" to the product number for the drawer, preconfigured compartment layout or roll-out shelf, e.g., RF31-362406A
- For replacement parts or to retrofit this mechanism, order an RY08-WWA

PRODUCT NO.  
A

## ECONO LOCK-IN MECHANISM

B



- Activated with the right hand by sliding the mechanism with thumb
- The drawer or roll-out shelf closes without having to reactivate the slide mechanism
- Stops drawer or roll-out shelf from opening on their own
- Easy to retrofit
- To order: Add B to the product number for the drawer, preconfigured compartment layout or roll-out shelf, e.g., RF31-362406B
- For replacement parts or to retrofit this mechanism, order an RY01-B

PRODUCT NO.  
B

## DRAWER LOCK

L3



- Compatible with all drawer dimensions
- Does not reduce the drawer's storage space
- Easy to retrofit
- To order: Add L3 to the product number for the drawer or preconfigured compartment layout, e.g., RF31-362406L3
- For replacement parts or to retrofit this mechanism, order an RY01-L3

PRODUCT NO.  
L3

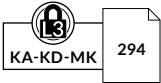

## LOCK-OUT MECHANISM

RF85

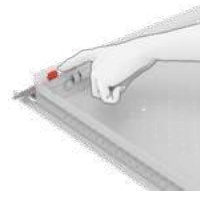

- For both drawers and roll-out shelves
- Locks drawers and roll-out shelves in an open position
- Activated manually, only when required
- Compatible with all drawer accessories
- Plastic bins in the back row may make it more difficult to activate the mechanism

PRODUCT NO.  
RF85

## ADJUSTABLE SHELF

RB20 / RB21



- For storage of bulky items
- The back and side edges prevent objects from falling to the bottom of the cabinet
- Height can be adjusted in 1" increments c/c
- Up to 400lb. load capacity, evenly distributed
- Includes perforations on the top spaced 3" apart c/c for inserting SH52 Partial Dividers. Allow 3" vertical clearance for installation, see page 13

PRODUCT NO.	HOUSING SIZE W x D	LOAD CAPACITY (LB.)
RB20-1821	18" x 21"	200
RB20-1827	18" x 27"	200
RB20-2421	24" x 21"	200
RB20-2427	24" x 27"	200
RB21-3021	30" x 21"	400
RB21-3027	30" x 27"	400
RB21-3618	36" x 18"	400
RB21-3624	36" x 24"	400
RB21-3627	36" x 27"	400
RB21-4821	48" x 21"	400
RB21-4824	48" x 24"	400
RB21-4827	48" x 27"	400
RB21-5424	54" x 24"	400
RB21-5427	54" x 27"	400
RB21-6024	60" x 24"	400
RB21-6027	60" x 27"	400

NOTE: Actual usable space is 2" c/c less than the height, 2 1/8" c/c less than the width and 4" c/c less than the depth.

## BOTTOM SHELF

RB23 / RB25



- For storage of bulky items
- The back and side edges prevent objects from falling to the bottom of the cabinet
- Up to 400lb. load capacity, evenly distributed
- Includes perforations on the top spaced 3" apart c/c for inserting SH52 Partial Dividers. Allow 3" vertical clearance for installation, see page 13

PRODUCT NO.	HOUSING SIZE W x D	LOAD CAPACITY (LB.)
RB23-1821	18" x 21"	200
RB23-1827	18" x 27"	200
RB23-2421	24" x 21"	200
RB23-2427	24" x 27"	200
RB25-3021	30" x 21"	400
RB25-3027	30" x 27"	400
RB25-3618	36" x 18"	400
RB25-3624	36" x 24"	400
RB25-3627	36" x 27"	400
RB25-4821	48" x 21"	400
RB25-4824	48" x 24"	400
RB25-4827	48" x 27"	400
RB25-5424	54" x 24"	400
RB25-5427	54" x 27"	400
RB25-6024	60" x 24"	400
RB25-6027	60" x 27"	400

NOTES: Actual usable space is 2" c/c less than the height, 2 1/8" c/c less than the width and 4" c/c less than the depth.  
For compatibility with double integrated doors or integrated sliding doors, order an adjustable shelf



DOORS, HANDLES AND LOCKS

SINGLE INTEGRATED DOOR, SOLID OR POLYCARBONATE



RB62 / RB61

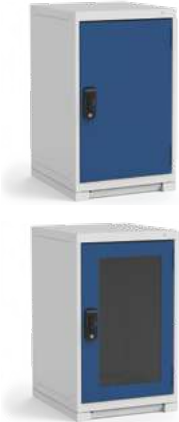

- Integrated door: RB62
- Polycarbonate integrated door: RB61
- Single door for 18"W, 24"W, 30"W and 36"W cabinets
- RB62 integrated doors have a finished back for increased rigidity and aesthetics
- RB61 integrated polycarbonate doors have excellent impact resistance
- Integrated doors are adjustable vertically and horizontally
- Compatible with RB23/RB25 Bottom Shelf and RB21/RB20 Adjustable Shelf
- Opens 180° for full access to items stored inside
- Factory installed on RA30 cabinet housings
- Some integrated door heights can be combined with drawers mounted above or below. For the latter case, you must order an RB20/RB21 Adjustable Shelf and install it above the bank of drawers
- Three types of lock available: L3 for a standard central lock, LP for a safety hasp or L50 for an electronic lock
- To order: Specify the type of door and lock required, e.g., RB61-3034L50 for a 30"W x 34"H integrated polycarbonate door and L50 electronic lock
- For a retrofit L50 mechanism or to replace the lock on a single integrated solid or polycarbonate door with an electronic lock, order an: RY50-L50

PRODUCT NO.	W x H
RB_-1820_	18" x 20"
RB_-1824_	18" x 24"
RB_-1826_	18" x 26"
RB_-1830_	18" x 30"
RB_-1834_	18" x 34"
RB_-1840_	18" x 40"
RB_-1854_	18" x 54"
RB_-2420_	24" x 20"
RB_-2424_	24" x 24"
RB_-2426_	24" x 26"
RB_-2430_	24" x 30"
RB_-2434_	24" x 34"
RB_-2440_	24" x 40"
RB_-2454_	24" x 54"

PRODUCT NO.	W x H
RB_-3020_	30" x 20"
RB_-3024_	30" x 24"
RB_-3026_	30" x 26"
RB_-3030_	30" x 30"
RB_-3034_	30" x 34"
RB_-3040_	30" x 40"
RB_-3054_	30" x 54"
RB_-3620_	36" x 20"
RB_-3624_	36" x 24"
RB_-3626_	36" x 26"
RB_-3630_	36" x 30"
RB_-3634_	36" x 34"
RB_-3640_	36" x 40"
RB_-3654_	36" x 54"



R5XEE-1004

NOTE: Not compatible with RF31 / RF35 drawers or RF40 / RF44 roll-out shelves



## DOUBLE INTEGRATED DOORS, SOLID OR POLYCARBONATE



- Integrated door: RB67
- Polycarbonate integrated door: RB66
- Double doors for 30"W, 36"W, 48"W, 54"W and 60"W cabinets
- RB67 integrated doors have a finished back for increased rigidity and aesthetics
- RB66 double integrated polycarbonate doors have excellent impact resistance
- Integrated doors are adjustable vertically and horizontally
- Compatible with RB21 Adjustable Shelf
- Opens 180° for full access to items stored inside
- Factory installed on RA30 cabinet housings
- Some integrated door heights can be combined with drawers mounted above or below. You must order an RB20 / RB21 Adjustable Shelf and install it above the bank of drawers for drawers mounted below, or an RB65 crossbar for drawers mounted above



- Three types of lock available: L3 for a standard central lock, LP for a safety hasp or L50 for an electronic lock
- To order: Specify the type of door and lock required, e.g., RB66-4820L3 for 48"W x 20"H double integrated polycarbonate doors and a standard central lock
- For a retrofit L50 mechanism or to replace the lock on double integrated doors, solid or polycarbonate, with an electronic lock, order an: RY51-L50

PRODUCT NO.	W x H
RB_-3020__	30" x 20"
RB_-3024__	30" x 24"
RB_-3026__	30" x 26"
RB_-3030__	30" x 30"
RB_-3034__	30" x 34"
RB_-3040__	30" x 40"
RB_-3054__	30" x 54"
RB_-3620__	36" x 20"
RB_-3624__	36" x 24"
RB_-3626__	36" x 26"
RB_-3630__	36" x 30"
RB_-3634__	36" x 34"
RB_-3640__	36" x 40"
RB_-3654__	36" x 54"
RB_-4820__	48" x 20"
RB_-4824__	48" x 24"
RB_-4826__	48" x 26"
RB_-4830__	48" x 30"

PRODUCT NO.	W x H
RB_-4834__	48" x 34"
RB_-4840__	48" x 40"
RB_-4854__	48" x 54"
RB_-5420__	54" x 20"
RB_-5424__	54" x 24"
RB_-5426__	54" x 26"
RB_-5430__	54" x 30"
RB_-5434__	54" x 34"
RB_-5440__	54" x 40"
RB_-5454__	54" x 54"
RB_-6020__	60" x 20"
RB_-6024__	60" x 24"
RB_-6026__	60" x 26"
RB_-6030__	60" x 30"
RB_-6034__	60" x 34"
RB_-6040__	60" x 40"
RB_-6054__	60" x 54"

NOTES: Not compatible with RF31 / RF35 drawers or RF40 / RF44 roll-out shelves.  
Not compatible with RB25 Bottom Shelf.

## DOUBLE DOORS WITH FRAME, SOLID OR POLYCARBONATE



- Double doors with frame: RB75
- Double polycarbonate doors with frame: RB76
- Double doors for 30"W, 36"W, 48"W, 54"W and 60"W cabinets
- RB76 double polycarbonate doors with frame have excellent impact resistance
- Installs on cabinets with drawers or roll-out shelves
- Opens 180° for full access to items stored inside
- Factory installed on RA30 cabinet housings
- Thickness of the frame: 3"
- Three types of lock available: L3 for a standard central lock, LP for a safety hasp or L50 for an electronic lock
- To order: Specify the type of door and lock required, e.g., RB76-4824LP for 48"W x 24"H double polycarbonate doors with frame and a safety hasp



- For a retrofit L50 mechanism or to replace the lock on double doors with frame, solid or polycarbonate, with an electronic lock, order an: RY52-L50

PRODUCT NO.	W x H
RB_-3024__	30" x 24"
RB_-3028__	30" x 28"
RB_-3030__	30" x 30"
RB_-3034__	30" x 34"
RB_-3038__	30" x 38"
RB_-3044__	30" x 44"
RB_-3058__	30" x 58"
RB_-3624__	36" x 24"
RB_-3628__	36" x 28"
RB_-3630__	36" x 30"
RB_-3634__	36" x 34"
RB_-3638__	36" x 38"
RB_-3644__	36" x 44"
RB_-3658__	36" x 58"
RB_-4824__	48" x 24"
RB_-4828__	48" x 28"
RB_-4830__	48" x 30"
RB_-4834__	48" x 34"

PRODUCT NO.	W x H
RB_-4838__	48" x 38"
RB_-4844__	48" x 44"
RB_-4858__	48" x 58"
RB_-5424__	54" x 24"
RB_-5428__	54" x 28"
RB_-5430__	54" x 30"
RB_-5434__	54" x 34"
RB_-5438__	54" x 38"
RB_-5444__	54" x 44"
RB_-5458__	54" x 58"
RB_-6024__	60" x 24"
RB_-6028__	60" x 28"
RB_-6030__	60" x 30"
RB_-6034__	60" x 34"
RB_-6038__	60" x 38"
RB_-6044__	60" x 44"
RB_-6058__	60" x 58"

## CROSSBAR FOR DOUBLE INTEGRATED DOORS

RB65



- Required for double integrated doors with drawers above
- Required a crossbar for double integrated doors with an electronic lock and drawers above, complete the following product code: RB65-WWL50

PRODUCT NO.	WIDTH
RB65-30__	30"
RB65-36__	36"
RB65-48__	48"
RB65-54__	54"
RB65-60__	60"

## INTEGRATED SLIDING DOORS, SOLID OR POLYCARBONATE

RB50 / RB51



- Integrated sliding doors: RB50
- Integrated sliding polycarbonate doors: RB51
- Doors for 48"W, 54"W and 60"W single cabinets
- RB51 integrated polycarbonate doors have excellent impact resistance
- Compatible with RB21 Adjustable Shelf
- Provides maximum clearance for handling items stored in the cabinet
- Factory installed on RA30 cabinet housings
- Standard lock included
- To order: Specify the type of door required, e.g., RB51-6020L3 for a 60"W x 20"H integrated sliding polycarbonate door

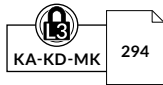

PRODUCT NO.	W x H
RB__-4820L3	48" x 20"
RB__-4824L3	48" x 24"
RB__-4826L3	48" x 26"
RB__-4830L3	48" x 30"
RB__-4834L3	48" x 34"
RB__-4840L3	48" x 40"
RB__-4854L3	48" x 54"
RB__-5420L3	54" x 20"
RB__-5424L3	54" x 24"
RB__-5426L3	54" x 26"
RB__-5430L3	54" x 30"
RB__-5434L3	54" x 34"
RB__-5440L3	54" x 40"
RB__-5454L3	54" x 54"
RB__-6020L3	60" x 20"
RB__-6024L3	60" x 24"
RB__-6026L3	60" x 26"
RB__-6030L3	60" x 30"
RB__-6034L3	60" x 34"
RB__-6040L3	60" x 40"
RB__-6054L3	60" x 54"

NOTES: Not compatible with RF31 / RF35 drawers or RF40/RF44 roll-out shelves  
 Not compatible with RB25 Bottom Shelf  
 Not compatible with L50 Electronic Door Lock.

## SLIDING DOORS WITH FRAME, SOLID OR POLYCARBONATE

RB55 / RB56



- Sliding doors with frame: RB55
- Sliding polycarbonate doors with frame RB56
- Sliding doors for double cabinets (2 x 24"W or 2 x 30"W)
- Compatible with double cabinets (2 x 24"W or 2 x 30"W) with drawers or roll-out shelves
- RB56 integrated polycarbonate doors have excellent impact resistance
- Provides maximum clearance for handling items stored in the cabinet
- Factory installed on RA30 cabinet housings
- Standard lock included
- Thickness of the frame: 3"
- To order: Specify the type of door required, e.g., RB56-6024L3 for a 60"W x 24"H sliding polycarbonate door with frame



PRODUCT NO.	W x H
RB__-4824L3	48" x 24"
RB__-4828L3	48" x 28"
RB__-4830L3	48" x 30"
RB__-4834L3	48" x 34"
RB__-4838L3	48" x 38"
RB__-4844L3	48" x 44"
RB__-4858L3	48" x 58"
RB__-6024L3	60" x 24"
RB__-6028L3	60" x 28"
RB__-6030L3	60" x 30"
RB__-6034L3	60" x 34"
RB__-6038L3	60" x 38"
RB__-6044L3	60" x 44"
RB__-6058L3	60" x 58"

NOTES: Not compatible with 48"W, 54"W or 60"W single cabinets.  
 Not compatible with L50 Electronic Door Lock.

### ROTATING HANDLE

Door opens by turning handle to the left or the right.



### LOCK POSITION

The hasp or lock are positioned so they do not impede the hand.



### DOUBLE LOCK

Add a second lock to your door.



### ELECTRONIC LOCK

Easier management of cabinet access permissions.



- Two L3 / LP locks can be used for maximum security
- To order: Specify the type of lock required, e.g., RB61-3034L3+CZ06-LP to add an LP lock as well as the lock ordered

PRODUCT NO.	DESCRIPTION
CZ05-L3	To add an L3 lock
CZ06-LP	To add an LP lock

NOTE: To add a second lock to an existing door, please contact Customer Service.

# L COMPACT STATIONARY CABINET



## L COMPACT STATIONARY CABINET

The L Compact Stationary Cabinet has been developed to better meet our customers' needs in terms of dimensions offered, drawer configurations and accessories that fit in a compact cabinet.

The L Compact Stationary Cabinet is 18" wide and comes in two depths (21" and 27") and five heights (24", 28", 30", 34" and 40"). A 2" or 4" painted steel or stainless steel base can also be added to raise the cabinet height slightly or to create more space for feet. With the security system, you can lock all the drawers with a single action.

There are 6 different drawer heights available from 3" to 12", and the drawers can be accessorized with partitions, dividers and plastic bins for optimal organization of your parts. Each drawer has a 100lb. load capacity and an ergonomic, easy-grip handle.

The unique shape of the L drawer is a Rousseau Metal Inc. trademark.

The L Compact Stationary Cabinet is an excellent alternative to the R heavy-duty line. Learn more in the following pages.



L3ABD-2418L3C

L3ABD-3442L3C

## THE ROUSSEAU DIFFERENCE



100lb. load capacity per drawer.  
100% extension for both drawer depths.

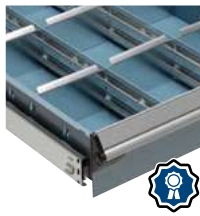

Partitions and dividers are clipped in.



Wide variety of drawer accessories available: full-depth partitions, dividers, plastic bins, hanging file holders, protective foam, etc.



Central locking on the cabinet housing.



Six drawer heights available: 3", 4", 5", 6", 8" and 12".



### LIFETIME WARRANTY

The Rousseau drawer rolling mechanism is covered by a lifetime warranty.

# PRECONFIGURED MODELS – CABINETS

HERE ARE SOME OF OUR MOST POPULAR PRECONFIGURED MODELS OF THE L COMPACT STATIONARY CABINETS

- The doors are factory installed with hinges on the left. They can be installed on the right upon request
- To order a lock on the cabinet housing (for models with more than one drawer) or on the door, add **L3** to the end of the product number
- To add an L50 electronic lock to a door or to your L cabinet, see **page 31**
- To order a cabinet with a 4" base, add **C** to the end of the product number for a painted steel base or **D** for a stainless steel base, e.g., L3ABD-2401L3 C for an 18"W x 21"D x 24"H cabinet, with four drawers, a lock and a 4"H painted steel base



### IMPORTANT

Drawer compartments are included in all models. See the table for the number of compartments.



To order drawers without compartments, replace the last two digits of the model number with the next even number up.

e.g., L3ABD-2401 with  
L3ABD-2402 without

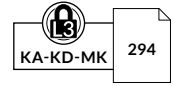

#### NUMBER OF COMPARTMENTS (LAYOUT CODE)

DRAWER DIMENSIONS	18"W x 21"D	18"W x 27"D
3"H to 5"H	9 (0206)	9 (0206)
6"H and 8"H	6 (0104)	6 (0104)
12"H	4 (0102)	4 (0102)

## 24" HIGH (W x D x H)



4 DRAWERS  
L3ABD-2401\_\_ 18" x 21" x 24"  
L3ABG-2401\_\_ 18" x 27" x 24"



4 DRAWERS  
L3ABD-2403\_\_ 18" x 21" x 24"  
L3ABG-2403\_\_ 18" x 27" x 24"



4 DRAWERS  
L3ABD-2405\_\_ 18" x 21" x 24"  
L3ABG-2405\_\_ 18" x 27" x 24"



3 DRAWERS  
L3ABD-2407\_\_ 18" x 21" x 24"  
L3ABG-2407\_\_ 18" x 27" x 24"



4 DRAWERS  
L3ABD-2409\_\_ 18" x 21" x 24"  
L3ABG-2409\_\_ 18" x 27" x 24"



1 DOOR / 1 SHELF  
L3ABD-2412\_\_ 18" x 21" x 24"  
L3ABG-2412\_\_ 18" x 27" x 24"



3 DRAWERS  
L3ABD-2421\_\_ 18" x 21" x 24"  
L3ABG-2421\_\_ 18" x 27" x 24"



3 DRAWERS  
L3ABD-2415\_\_ 18" x 21" x 24"  
L3ABG-2415\_\_ 18" x 27" x 24"



4 DRAWERS  
L3ABD-2417\_\_ 18" x 21" x 24"  
L3ABG-2417\_\_ 18" x 27" x 24"



5 DRAWERS  
L3ABD-2419\_\_ 18" x 21" x 24"  
L3ABG-2419\_\_ 18" x 27" x 24"

## 28" HIGH (W x D x H)



4 DRAWERS  
L3ABD-2801\_\_ 18" x 21" x 28"  
L3ABG-2801\_\_ 18" x 27" x 28"



4 DRAWERS  
L3ABD-2807\_\_ 18" x 21" x 28"  
L3ABG-2807\_\_ 18" x 27" x 28"



2 DRAWERS  
L3ABD-2809\_\_ 18" x 21" x 28"  
L3ABG-2809\_\_ 18" x 27" x 28"



3 DRAWERS  
L3ABD-2811\_\_ 18" x 21" x 28"  
L3ABG-2811\_\_ 18" x 27" x 28"



4 DRAWERS  
L3ABD-2819\_\_ 18" x 21" x 28"  
L3ABG-2819\_\_ 18" x 27" x 28"



6 DRAWERS  
L3ABD-2821\_\_ 18" x 21" x 28"  
L3ABG-2821\_\_ 18" x 27" x 28"



3 DRAWERS  
L3ABD-2803\_\_ 18" x 21" x 28"  
L3ABG-2803\_\_ 18" x 27" x 28"



2 DOORS / 1 SHELF  
L3ABD-2828\_\_ 18" x 21" x 28"  
L3ABG-2828\_\_ 18" x 27" x 28"



1 DRAWER / 1 DOOR  
L3ABD-2829\_\_ 18" x 21" x 28"  
L3ABG-2829\_\_ 18" x 27" x 28"



4 DRAWERS  
L3ABD-2835\_\_ 18" x 21" x 28"  
L3ABG-2835\_\_ 18" x 27" x 28"

# PRECONFIGURED MODELS – CABINETS

## 34" HIGH (W × D × H)



5 DRAWERS  
L3ABD-3403\_\_ 18" × 21" × 34"  
L3ABG-3403\_\_ 18" × 27" × 34"



4 DRAWERS  
L3ABD-3407\_\_ 18" × 21" × 34"  
L3ABG-3407\_\_ 18" × 27" × 34"



1 DRAWER / 1 DOOR / 1 SHELF  
L3ABD-3411\_\_ 18" × 21" × 34"  
L3ABG-3411\_\_ 18" × 27" × 34"



5 DRAWERS  
L3ABD-3415\_\_ 18" × 21" × 34"  
L3ABG-3415\_\_ 18" × 27" × 34"



5 DRAWERS  
L3ABD-3419\_\_ 18" × 21" × 34"  
L3ABG-3419\_\_ 18" × 27" × 34"



4 DRAWERS  
L3ABD-3421\_\_ 18" × 21" × 34"  
L3ABG-3421\_\_ 18" × 27" × 34"



6 DRAWERS  
L3ABD-3405\_\_ 18" × 21" × 34"  
L3ABG-3405\_\_ 18" × 27" × 34"



1 DOOR / 1 SHELF  
L3ABD-3436\_\_ 18" × 21" × 34"  
L3ABG-3436\_\_ 18" × 27" × 34"



6 DRAWERS  
L3ABD-3437\_\_ 18" × 21" × 34"  
L3ABG-3437\_\_ 18" × 27" × 34"



4 DRAWERS  
L3ABD-3447\_\_ 18" × 21" × 34"  
L3ABG-3447\_\_ 18" × 27" × 34"

## 40" HIGH (W × D × H)



6 DRAWERS  
L3ABD-4005\_\_ 18" × 21" × 40"  
L3ABG-4005\_\_ 18" × 27" × 40"

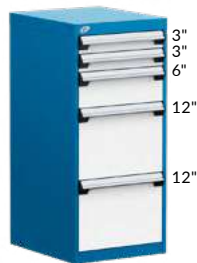

5 DRAWERS  
L3ABD-4047\_\_ 18" × 21" × 40"  
L3ABG-4047\_\_ 18" × 27" × 40"



8 DRAWERS  
L3ABD-4011\_\_ 18" × 21" × 40"  
L3ABG-4011\_\_ 18" × 27" × 40"



4 DRAWERS / 1 DOOR / 1 SHELF  
L3ABD-4015\_\_ 18" × 21" × 40"  
L3ABG-4015\_\_ 18" × 27" × 40"



3 DRAWERS / 1 DOOR  
L3ABD-4017\_\_ 18" × 21" × 40"  
L3ABG-4017\_\_ 18" × 27" × 40"



3 DRAWERS  
L3ABD-4007\_\_ 18" × 21" × 40"  
L3ABG-4007\_\_ 18" × 27" × 40"



6 DRAWERS  
L3ABD-4025\_\_ 18" × 21" × 40"  
L3ABG-4025\_\_ 18" × 27" × 40"

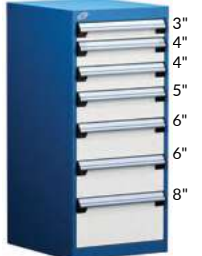

7 DRAWERS  
L3ABD-4027\_\_ 18" × 21" × 40"  
L3ABG-4027\_\_ 18" × 27" × 40"



6 DRAWERS  
L3ABD-4029\_\_ 18" × 21" × 40"  
L3ABG-4029\_\_ 18" × 27" × 40"



6 DRAWERS  
L3ABD-4031\_\_ 18" × 21" × 40"  
L3ABG-4031\_\_ 18" × 27" × 40"

# PRECONFIGURED MODELS – DRAWER COMPARTMENTS

## DRAWER DIMENSIONS

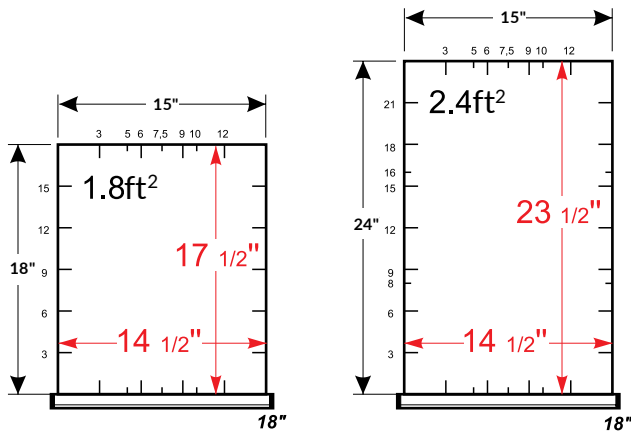

**CHOOSE DRAWERS FROM OUR SELECTION OF PRECONFIGURED COMPARTMENT LAYOUTS**

00 for subdividing kit only  
51 for a drawer in a cabinet with compartments

L \_\_ BD-A0200 \_\_

Drawer height :  
 3", 4", 5", 6", 8" and 12"

L3 Drawer lock  
 B Lock-in mechanism

e.g., L51BD-A020008 L3 B

For an 18"W x 21"D drawer with compartments, 8" drawer height, an L3 lock and a lock-in mechanism on the drawer.

## 18" x 21" (W x D) DRAWERS

### PARTITIONS AND DIVIDERS

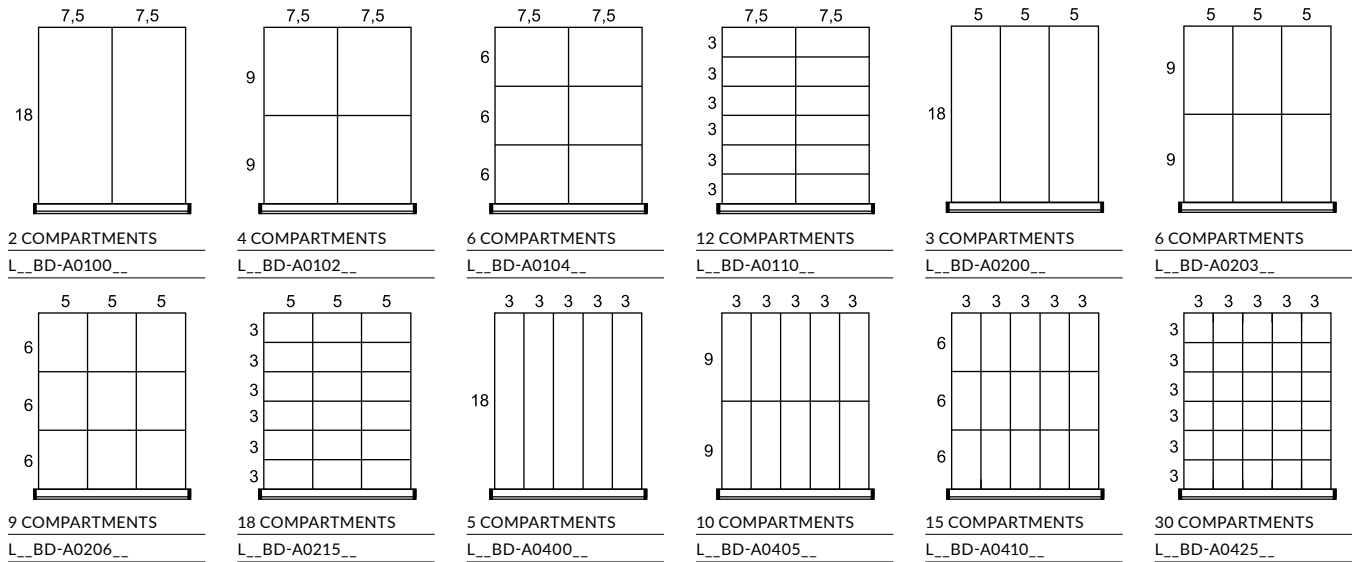

### PLASTIC BINS

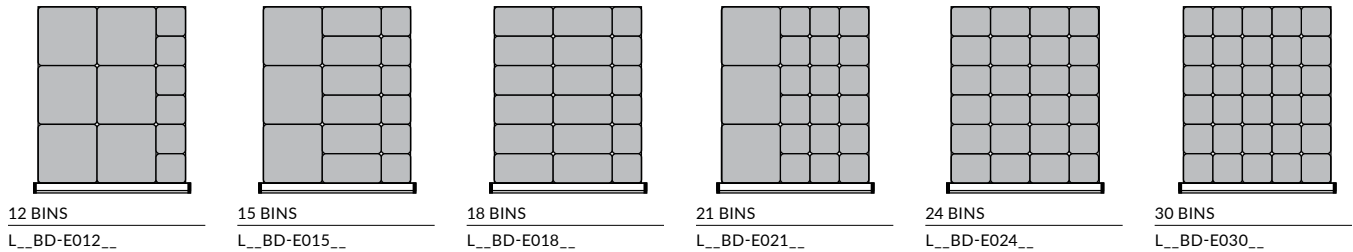

### FOAM/LINERS

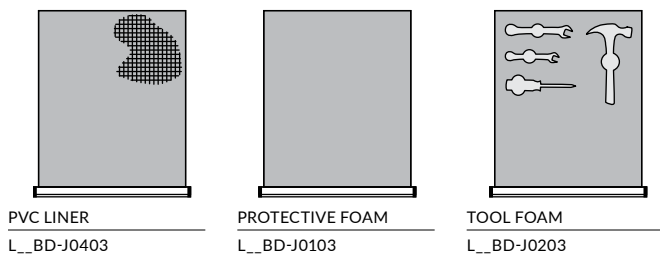

### FILE HOLDERS

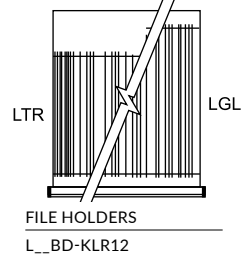

# PRECONFIGURED MODELS – DRAWER COMPARTMENTS

## 18" x 27" (W x D) DRAWERS

### PARTITIONS AND DIVIDERS

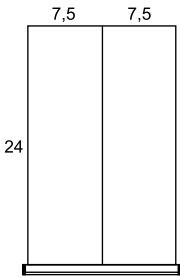

2 COMPARTMENTS  
L\_\_BG-A0100\_\_

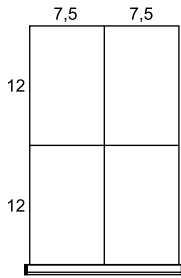

4 COMPARTMENTS  
L\_\_BG-A0102\_\_

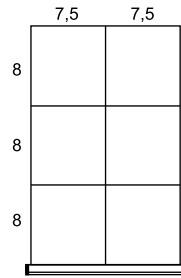

6 COMPARTMENTS  
L\_\_BG-A0104\_\_

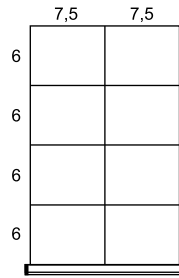

8 COMPARTMENTS  
L\_\_BG-A0106\_\_

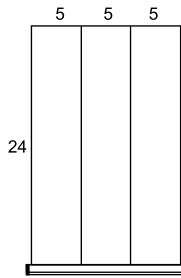

3 COMPARTMENTS  
L\_\_BG-A0200\_\_

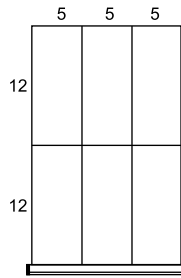

6 COMPARTMENTS  
L\_\_BG-A0203\_\_

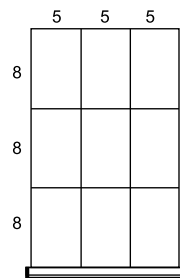

9 COMPARTMENTS  
L\_\_BG-A0206\_\_

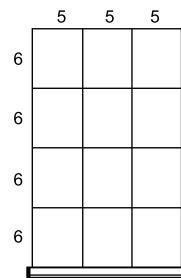

12 COMPARTMENTS  
L\_\_BG-A0209\_\_

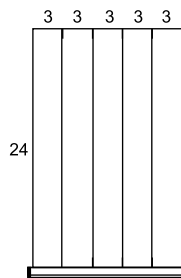

5 COMPARTMENTS  
L\_\_BG-A0400\_\_

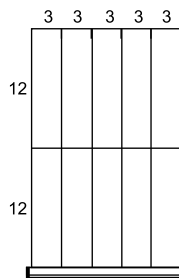

10 COMPARTMENTS  
L\_\_BG-A0405\_\_

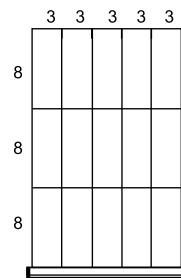

15 COMPARTMENTS  
L\_\_BG-A0410\_\_

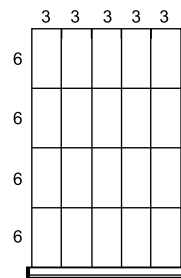

20 COMPARTMENTS  
L\_\_BG-A0415\_\_

### PLASTIC BINS

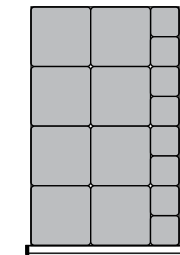

16 BINS  
L\_\_BG-E016\_\_

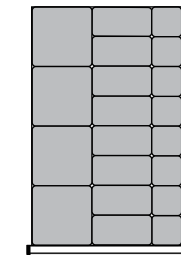

20 BINS  
L\_\_BG-E020\_\_

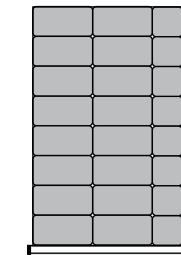

24 BINS  
L\_\_BG-E024\_\_

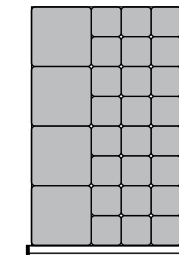

28 BINS  
L\_\_BG-E028\_\_

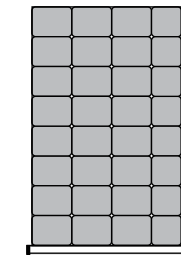

32 BINS  
L\_\_BG-E032\_\_

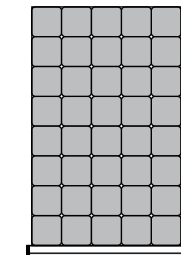

40 BINS  
L\_\_BG-E040\_\_

### FOAM/LINERS

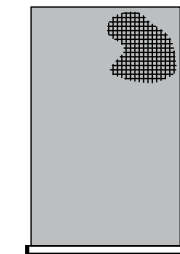

PVC LINER  
L\_\_BG-J0403

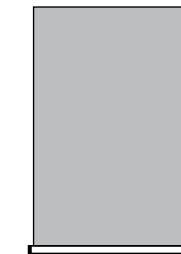

PROTECTIVE FOAM  
L\_\_BG-J0103

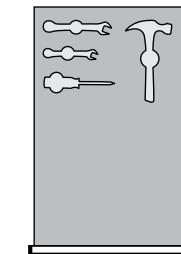

TOOL FOAM  
L\_\_BG-J0203



### FILE HOLDERS

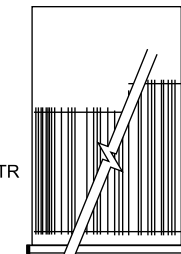

FILE HOLDERS  
L\_\_BG-KLR12



## SECURITY MECHANISMS

### ELECTRONIC LOCK SYSTEM FOR CABINET WITH DRAWERS

L50



- Electronically locks all drawers in the cabinet at the same time
- No key required
- Up to 20 different users can be programmed
- 4-8 digit access codes
- Simplifies access management to drawers
- To order the complete mechanism with a cabinet with drawers, order an LB00-DDHHL50
- To order as a replacement lock, order an HA52-L50

**PRODUCT NO.**

L50

### ELECTRONIC LOCK FOR DOORS

L50



- Electronically locks a cabinet door
- No key required
- Up to 20 different users can be programmed
- 4-8 digit access codes
- Compatible with LB30 integrated doors
- To order: Add L50 to the door product code, e.g. LB30-1812L50

**PRODUCT NO.**

L50

NOTE: Cannot be retrofitted.

### DRAWER LOCK

L3

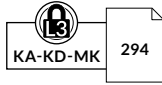

- Two keys provided with each lock
- Compatible with all drawer dimensions
- The mechanism (covered by a galvanized steel box) requires 3"W x 1"D space inside the drawer
- To order: Add L3 to the product number for the drawer or preconfigured compartment layout e.g., LF31-182106L3
- For replacement parts or to retrofit this mechanism, order an HA51-L3

**PRODUCT NO.**

L3

NOTE: An LF91 security panel must be ordered to block access between two drawers and if two different user access rights are required.

### CENTRAL LOCKING SYSTEM

L3 / LP



- Locks all drawers in the cabinet at the same time
- Easy to retrofit
- The drawer layout can be changed without touching the locking mechanism
- To order a lock, add L3 to the cabinet housing or preconfigured model number e.g., LA30-182134L3
- To order a safety hasp, add LP to the cabinet housing product number e.g., LA30-182134LP
- For replacement parts or to retrofit this mechanism, order an LB00-DDHH\_\_ and specify the type of lock required

**PRODUCT NO.**

L3 Key lock

LP Safety hasp

### DOOR LOCK

L3/LP

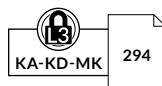

- Two keys provided with each lock
- To order a key lock, add L3 to the door product number e.g., LB30-1812L3
- To order a safety hasp, add LP to the door product number e.g., LB30-1812LP
- For replacement parts or to retrofit this mechanism, order an HA49-L3 or HA49-LP

**PRODUCT NO.**

L3 Key lock

LP Safety hasp

NOTE: An LF91 security panel must be ordered to block access between two doors and if two different user access rights are required.

### LOCK-IN MECHANISM

B



- Activated with the right hand by sliding the mechanism with thumb
- The drawer closes without having to reactivate the sliding mechanism
- Stops drawers from opening on their own
- Easy to retrofit
- To order: Add B to the product number for the drawer or preconfigured compartment layout e.g., LF31-182106B
- For replacement parts or to retrofit this mechanism, order an LY01 and a LY02

**PRODUCT NO.**

B

# ACCESSORIES

## DRAWER AND HANDLE ACCESSORIES

### HANDLE PROTECTOR

LF70



- Clips onto the drawer handle
- Made of transparent plastic
- Protects identification labels from dust, grease and dirt
- Easy to remove

PRODUCT NO.  
LF70-18

### HANDLE LABELS

LF71



- Labels to be attached to handles under the handle protector (LF70)
- 30 labels per page (10 pages)
- Print your own labels. A template is available on rousseau.com under Information Center > Document

PRODUCT NO.  
LF71-425075

### HANGING FILE BARS

LG31



- For storing hanging files
- Fits both letter and legal sizes
- For 12"H drawers

PRODUCT NO.  
LG31-18

### PVC DRAWER LINER

LG40



- Protects items stored in the drawer
- Non-slip material
- Can be installed under partitions and dividers
- Thickness: 3/32"

PRODUCT NO.	FOR DRAWER
LG40-1821-01	18"W x 21"D
LG40-1827-01	18"W x 27"D

### PROTECTIVE FOAM

LG41



- Protects items stored in the drawer
- Includes one piece of 1/4"-thick blue foam

PRODUCT NO.	FOR DRAWER
LG41-1821-01	18"W x 21"D
LG41-1827-01	18"W x 27"D

NOTE: Partitions and dividers cannot be installed in the same drawer as this foam.

### TOOL FOAM

LG42



- Oil resistant and non-absorbent
- Includes one piece of 1/4"-thick blue foam
- Includes one piece of 1/2"-thick black foam
- Sold without cut-outs. Can be cut with a utility knife

PRODUCT NO.	FOR DRAWER
LG42-1821-01	18"W x 21"D
LG42-1827-01	18"W x 27"D

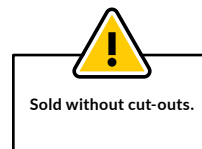

## FRONT TO BACK PARTITION



LG02



- Divides the drawer along its depth
- Clip system locks dividers in place
- Galvanized steel
- Compatible with RG10 dividers, which can be used to make smaller compartments between each partition
- Compatible with plastic bins and PVC drawer liners

NOMINAL DRAWER HEIGHT (ACTUAL)	NOMINAL DRAWER DEPTH (ACTUAL)	
	21" (18")	27" (24")
3" (1½"H)	LG02-2103	LG02-2703
4" (2½"H)	LG02-2104	LG02-2704
5" (3½"H)	LG02-2105	LG02-2705
6" (4½"H)	LG02-2106	LG02-2706
8" (6½"H)	LG02-2108	LG02-2708
12" (8½"H)	LG02-2110	LG02-2710

## PLASTIC BIN



RG20



- For easier storing, moving and managing of small parts
- Lightweight and durable
- For 3"H and 4"H drawers
- 45° angled rim for easy identification of bin contents and removal of bins
- Compatible with partitions and dividers
- 6" plastic bins can be subdivided

DIMENSIONS			PRODUCT NO.		
W	D	H	BIN	PARTITION	DIVIDER
3"	3"	2"	RG20-030302	-	-
4"	3"	2"	RG20-040302	-	-
6"	3"	2"	RG20-060302	RG22-0302	-
6"	6"	2"	RG20-060602	RG22-0602	RG24-0602
3"	3"	3"	RG20-030303	-	-
4"	3"	3"	RG20-040303	-	-
6"	3"	3"	RG20-060303	RG22-0303	-
6"	6"	3"	RG20-060603	RG22-0603	RG24-0603

NOTE: 2"H bins = 1½" actual height  
3"H bins = 2½" actual height

## DRAWER DIVIDER



RG10



- Dividers clip in place
- 45° angled edge for easy identification of compartment contents
- Adjustable in 3" increments (c/c)
- Galvanized steel

NOMINAL DIVIDER WIDTH	NOMINAL DRAWER HEIGHT (ACTUAL)					
	3" (1½"H)	4" (2¾"H)	5" (3¾"H)	6" (4½"H)	8" (6½"H)	12" (8½"H)
3"	RG10-03003	RG10-03004	RG10-03005	RG10-03006	RG10-03008	RG10-03010
5"	RG10-05003	RG10-05004	RG10-05005	RG10-05006	RG10-05008	RG10-05010
6"	RG10-06003	RG10-06004	RG10-06005	RG10-06006	RG10-06008	RG10-06010
7½"	RG10-07503	RG10-07504	RG10-07505	RG10-07506	RG10-07508	RG10-07510
9"	RG10-09003	RG10-09004	RG10-09005	RG10-09006	RG10-09008	RG10-09010
10"	RG10-10003	RG10-10004	RG10-10005	RG10-10006	RG10-10008	RG10-10010
12"	RG10-12003	RG10-12004	RG10-12005	RG10-12006	RG10-12008	RG10-12010
15"	RG10-15003	RG10-15004	RG10-15005	RG10-15006	RG10-15008	RG10-15010



## CABINET TOPS

### RESISTANT ACRYLIC/PVC PLASTIC LAMINATED TOP

WS08



- Ideal for assembly stations or for applications using solvents, oils or other chemical products
- Color: grey
- Premium-quality laminated top
- Excellent chemical resistance (can be in prolonged contact with a substance)
- Superior abrasion resistance compared with standard laminated tops
- Superior impact resistance compared with standard laminated tops
- Attractive appearance
- Thickness: 1½"

### STEEL TOP WITH RUBBER MAT

RC32



- Non-slip rubber surface
- Includes edges on the sides and back
- Height: 1"

### STAINLESS STEEL TOP

RC35



- Acts as a work surface and protects the cabinet from impacts
- Particle board top with stainless steel cover (#4 brushed finish)
- Excellent corrosion and chemical resistance
- Top complies with CARB regulations on formaldehyde emissions
- Includes welded corners for an attractive appearance
- Thickness: 1¾"

### LAMINATED HARDWOOD TOP

WS14



- Top for general industrial applications
- Made from varnished hardwood slats
- Includes a 90° radius front edge for extra comfort
- High impact resistance
- Attractive appearance
- Thickness: 1¾"

### PAINTED STEEL TOP

RC37



- Acts as a work surface and protects the cabinet from impacts
- Particle board top with painted steel cover
- Top complies with CARB regulations on formaldehyde emissions
- Includes welded corners for an attractive appearance
- Thickness: 1¾"

### PLASTIC LAMINATED TOP

WS16



- Top for general use. Ideal for assembly stations, quality control and packaging
- Color: white
- Attractive appearance
- Easy to clean
- Includes a 90° radius front edge for extra comfort
- Thickness: 1½"

### DISSIPATIVE TOP

WS17



- Top for electronics tasks. Ideal for electronics inspection or assembly stations
- Color: white
- Attractive appearance
- Easy to clean
- Includes a 90° radius front edge for extra comfort
- Dissipates electrical charges that can damage electronic components
- The resistance point to point and point to ground is between 10<sup>6</sup> and 10<sup>9</sup> Ω
- Thickness: 1½"

NOTE: Grounding accessories are sold separately, see page 171.

DIMENSIONS		CABINET TOPS						
W	D	ACRYLIC/PVC PLASTIC LAMINATED	LAMINATED HARDWOOD	PLASTIC LAMINATED	DISSIPATIVE	STEEL TOP WITH RUBBER MAT	STAINLESS STEEL	PAINTED STEEL
18"	21"		WS14-1821A*	WS16-1821A*		RC32-1821-01	RC35-1821	RC37-1821
	27"		WS14-1827A*	WS16-1827A*		RC32-1827-01	RC35-1827	RC37-1827
36"	21"	WS08-3621A*	WS14-3621A*	WS16-3621A*	WS17-3621A*	RC32-3621-01	RC35-3621	RC37-3621
	27"	WS08-3627A*	WS14-3627A*	WS16-3627A*	WS17-3627A*	RC32-3627-01	RC35-3627	RC37-3627
54"	21"	WS08-5421A*	WS14-5421A*	WS16-5421A*	WS17-5421A*	RC32-5421-01	RC35-5421	RC37-5421
	27"	WS08-5427A*	WS14-5427A*	WS16-5427A*	WS17-5427A*	RC32-5427-01	RC35-5427	RC37-5427

NOTE: \* Please check with your Customer Service representative for lead times.

## ESD PROTECTION

### ESD CABINET

LC50



- Special paint dissipates electrical charges
- Includes a grounding cord and ground wrist strap socket. The cord resistance is 1MΩ
- To order a cabinet with ESD protection, please order an LC50-01 grounding kit and specify dissipative paint color Black 090

PRODUCT NO.  
LC50-01

NOTE: Contact Customer Service for ESD paint prices.

### GROUNDING WRIST STRAP



- Made of stretch fabric
- Includes a 6" cord with 1MΩ resistance
- Dissipates electric charges that can damage electronic components

PRODUCT NO.  
70000320

### CONDUCTIVE PLASTIC BINS



245

### DISSIPATIVE TOP



144

## BASES

### LEVELING GLIDE KIT

LA74

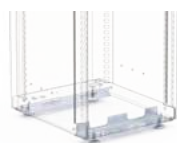

- Adjusts the height of cabinets 1 1/8" to 2" on uneven floor surfaces
- Can be installed under cabinets with or without bases
- Includes two brackets and four leveling glides

PRODUCT NO.      WIDTH  
LA74-1801      18"

### FLOOR ANCHORING KIT

LA76



- For anchoring a cabinet (without base) to the floor
- Includes one bolt for concrete floors

PRODUCT NO.      WIDTH  
LA76-1801      18"

## STACKING CABINETS

### STACKING KIT

LA78

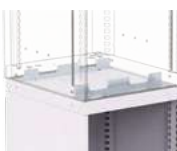

- For stacking an L compact cabinet on top of another
- Installs on the bottom of the top cabinet
- Includes two brackets and anchoring hardware

PRODUCT NO.      WIDTH  
LA78-1801      18"



L3XJD-2802L3

### HOUSINGS

#### L COMPACT CABINET HOUSING

LA30



- Drawers, shelves and doors can be installed in the housing
- The housing units include knockouts:
  - On the top: for stacking an LD75 Housing for Drawer Unit or another LA30 L Compact Cabinet Housing. For the latter, order an LA78 Stacking Kit
  - On the sides and back: for assembling cabinets side to side and back to back, or for installing under a work surface. For the latter, order RA70 Cabinet Attachment Bars
- A 2" painted or stainless steel base can be added to make cabinet heights of 26", 30", 32", 36" and 42"
- A 4" painted or stainless steel base can be added to make cabinet heights of 28", 32", 34", 38" and 44"
- To order a lock on the housing that locks all drawers at the same time, add L3 to the product number, [see page 31](#)
- To order a safety hasp, add LP to the product number, [see page 31](#)
- For factory installation of an electronic lock, order an LB00-DDHHL50, [see page 31](#)

PRODUCT NO.	W x D x H
LA30-182124__	18" x 21" x 24"
LA30-182128__	18" x 21" x 28"
LA30-182130__	18" x 21" x 30"
LA30-182134__	18" x 21" x 34"
LA30-182140__	18" x 21" x 40"
LA30-182724__	18" x 27" x 24"
LA30-182728__	18" x 27" x 28"
LA30-182730__	18" x 27" x 30"
LA30-182734__	18" x 27" x 34"
LA30-182740__	18" x 27" x 40"

#### L COMPACT DRAWER



- 100lb. load capacity, 100% extension
- Vast choice of accessories available to customize the drawer to your storage needs
- Precision ball bearing drawer slides included
- Easy hook-on assembly
- For preconfigured drawer compartment layouts, [see pages 29-30](#)
- Drawer heights available: 3", 4", 5", 6", 8" and 12"
- To order: Add the drawer height required to the product number, e.g., LF31-182106
- To order a drawer lock, add L3 to the drawer product number, e.g., LF31-182704L3. The mechanism (covered by a galvanized steel box) requires 3"W x 1"D space inside the drawer
- To order a drawer lock-in mechanism, add "B" to the drawer product number, e.g., LF31-182103B

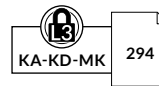

PRODUCT NO.	W x D	INSIDE DIM.
LF31-1821__	18" x 21"	15" x 18"
LF31-1827__	18" x 27"	15" x 24"

#### L 3-SIDES ACCESS ROLL-OUT SHELF



- 100lb. load capacity, 100% extension
- Precision ball bearing drawer slides included
- Easy hook-on assembly
- Galvanized steel top with 1 1/2" H back
- Total height: 4"

PRODUCT NO.	W x D	INSIDE DIM.
LF44-1821	18" x 21"	15" x 18"
LF44-1827	18" x 27"	15" x 24"

#### DRAWER AND ROLL-OUT SHELF DIMENSIONS

LA30

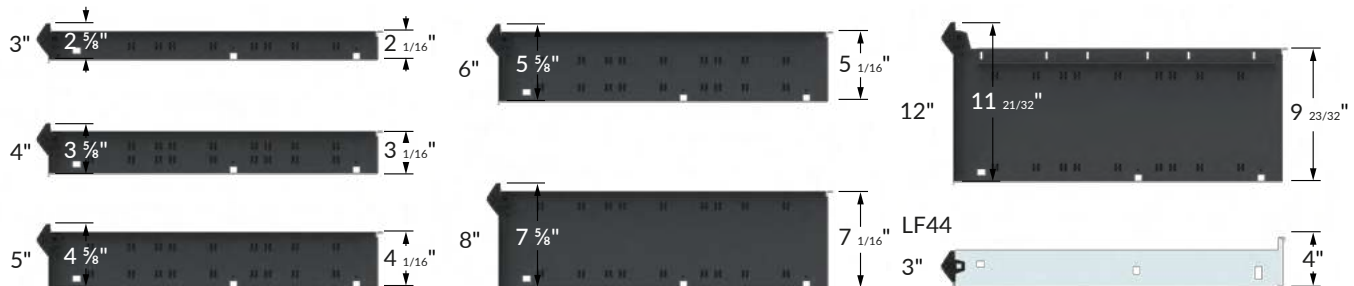

## CABINET BASE

LA85 / LA86



- Painted steel: LA85
- Stainless steel: LA86
- Heights available: 2" and 4"
- Recessed 2" from the front to create more space for feet
- Compatible with LA74 Leveling Glide Kit
- To order: Specify the type of steel required, e.g., LA86-182704 for an 18"W x 27"D x 4"H stainless steel base

PRODUCT NO.	W x D x H
LA__-182102	18" x 21" x 2"
LA__-182104	18" x 21" x 4"
LA__-182702	18" x 27" x 2"
LA__-182704	18" x 27" x 4"

NOTE: Not compatible with LA76 Floor Anchoring Kit, LA78 Stacking Kit and casters

## INTEGRATED DOOR

LB30



- Seven standard heights available
- Black plastic recessed handle
- The doors are factory installed with hinges on the left. They can be installed on the right upon request
- An LB24 Adjustable Shelf must be ordered as a storage surface for doors installed above a drawer or another door
- To order a key lock, add L3 to the product number
- To order a safety hasp, add LP to the door product number
- To order an electronic lock for doors, add L50 to the product number

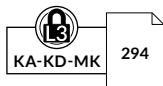

PRODUCT NO.	W x H
LB30-1812__	18" x 12"
LB30-1818__	18" x 18"
LB30-1820__	18" x 20"
LB30-1824__	18" x 24"
LB30-1826__	18" x 26"
LB30-1830__	18" x 30"
LB30-1836__	18" x 36"

## SECURITY PANEL

LF91



- Divides the cabinet up for use by more than one user
- Adjustable in 1" increments c/c
- Must be ordered to:
  - Block access between doors
  - Block access when a door with lock is installed under a drawer
  - Block the space left when a door is installed above a drawer
- Two security panel versions available for housings with or without a central locking mechanism
- Galvanized steel
- To order: Specify the housing depth, 21" or 27"

PRODUCT NO.	FOR LA30
LF91-18__01	With L3/LP on the housing
LF91-18__02	Without L3/LP on the housing

## HOUSING FOR DRAWER UNIT

LD75



- Installs on a cabinet or under a work surface
- 100lb. load capacity for each drawer in the unit, max. 175lb. per unit
- Compatible with LF31 compact drawers (not included)
- To order: Specify the drawer unit housing depth required, 21" or 27"

PRODUCT NO.	INTERIOR DIM.
LD75-18__09	6"
LD75-18__12	9"
LD75-18__15	12"

## DRAWER UNIT COVER

LD76



- Covers the top of an LD75 Housing for Drawer Unit when it is installed on a work surface

PRODUCT NO.	W x D
LD76-1821	18" x 21"
LD76-1827	18" x 27"

## VERTICAL SECURITY BAR

LB10



- Locks all drawers in a cabinet with a key or padlock
- The key or safety hasp is located at the top of the bar to facilitate access
- Covers a bank of drawers from 20" to 36" high
- Easy to assemble
- Installs on the right-hand side
- To order: Specify the type of lock required, LP for a safety hasp or L3 for a standard key lock

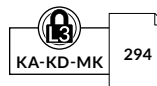

PRODUCT NO.	CABINET HEIGHT	VERTICAL SECURITY BAR HEIGHT
LB10-24__A	24"	20"
LB10-28__A	28"	24"
LB10-30__A	30"	26"
LB10-34__A	34"	30"
LB10-40__A	40"	36"

## ADJUSTABLE SHELF

LB24



- For storage of bulky items
- Includes side and back edges
- Height can be adjusted in 1" increments c/c
- Up to 100lb. load capacity, evenly distributed
- Two adjustable shelf versions available for housings with or without a central locking mechanism
- Galvanized steel
- To order: Specify the housing depth, 21" or 27"

PRODUCT NO.	FOR LA30
LB24-18__01	With L3/LP/L50 on the housing
LB24-18__02	Without L3/LP/L50 on the housing



INDEX	PAGE(S)
R Mobile Cabinet	38 - 39
Preconfigured Models . . .	40 - 44
Accessories . . . . .	45 - 49
Components . . . . .	50 - 54
<b>L Compact Mobile Cabinet</b>	<b>55</b>
Preconfigured Models . . .	56 - 57
Accessories . . . . .	58 - 62
Components . . . . .	63 - 65

## R MOBILE CABINET

Rousseau's R Heavy-Duty Mobile Cabinet is one of the safest and most secure on the market. With a simple upward movement with just one hand on one of the drawer's ergonomic handles, the drawer opens with incredible ease, and the lock-in mechanism is activated so none of the other drawers can open.

It is also easy to change the cabinet configuration as the drawer order can be changed at any time. Our specialists will be happy to help you configure a cabinet personalized for you and tailored to your customers' specific requirements.

The R Heavy-Duty Mobile Cabinet is manufactured to meet the rigorous demands of industrial applications and is therefore one of the most durable on the market. Our research and development department has put the cabinet through multiple demanding tests for load capacity, impact resistance, and wear and tear, so we are confident in its excellent durability. Fitted with high-quality, resistant casters, it has been designed for intensive use in harsh work environments.

There is also an extensive range of options and accessories available to further customize it to your needs. There are 6 different tops, 2 types of handle (on the front and side), foldaway shelves and hanging side cabinets. Furthermore, you no longer need to worry about replacing complete units as your business grows and evolves because these options and accessories can be easily retrofitted.

The unique design of the R drawer is a trademark of Rousseau Metal Inc.



R5BHE-3019



**LIFETIME WARRANTY**  
The Rousseau drawer rolling mechanism is covered by a lifetime warranty.



# R HEAVY-DUTY MOBILE CABINET

## THE ROUSSEAU DIFFERENCE



The integrated lock-in mechanism activates easily with just one hand (right or left).



The full-width ergonomic handle provides a comfortable grip when opening the drawer.

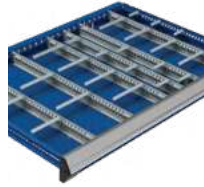

Variety of drawer accessories available: partitions, dividers, plastic bins, protective foam, etc.



Polyurethane casters for excellent maneuverability without marking floors.



Variety of cabinet accessories available: foldaway shelves, storage cabinets, wood tops, etc.



Industry-leading 400lb. load capacity per drawer.

## GENERAL DIMENSIONS

### HEIGHTS AVAILABLE



NOTE: The total height shown includes 6" casters and a 1 1/4"H top.

### WIDTH × DEPTH × HEIGHT

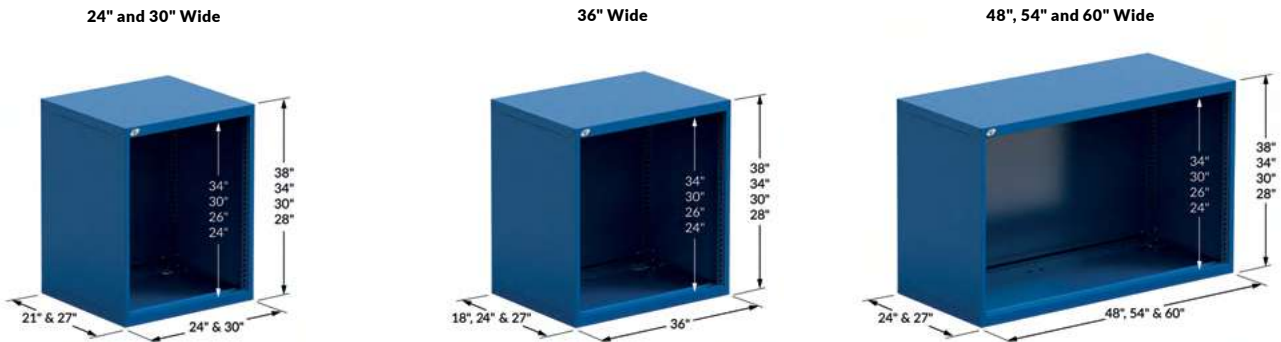

# PRECONFIGURED MODELS

HERE ARE SOME OF OUR MOST POPULAR PRECONFIGURED MODELS OF R HEAVY-DUTY MOBILE CABINETS

- Preconfigured models for 24"W cabinets have 4" casters, including two rigid and two swivel casters with total-lock brakes, as well as an econo lock-in mechanism (B)
- Preconfigured models for 30"W cabinets, or wider, have 6" casters, including two rigid and two swivel casters with total-lock brakes, as well as an integrated lock-in mechanism (A)
- All cabinets are fitted with a True One-Drawer-at-a-Time System
- The cabinets include a standard lock on the cabinet housing (and on the door)
- To add an L50 electronic lock to a door or to your R mobile cabinet, [see page 45](#)
- To add a stainless steel, painted steel, steel with rubber mat, wood or marine edge stainless steel top, [see page 46](#)
- All preconfigured models are factory assembled and ready to use. The doors are factory installed with hinges on the right-hand side. The hinges can be installed on the left upon request



NOTE: For interior drawer dimensions, [see pages 226-228](#).

### IMPORTANT

Drawer compartments are included in all models. See the number of compartments and suggested layouts below.

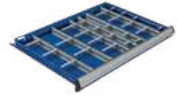

To order drawers without compartments, replace the last two digits of the model number with the next even number up.

e.g., R5BCD-2801 with R5BCD-2802 without

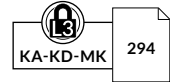

NUMBER OF COMPARTMENTS (LAYOUT CODE)

DRAWER DIMENSIONS	3"H TO 5"H	6"H TO 8"H	9"H AND HIGHER
24"W x 21"D	12 (0308)	9 (0206)	4 (0102)
24"W x 27"D	20 (0316)	12 (0209)	6 (0104)
30"W x 21"D	24 (0518)	12 (0308)	6 (0203)
30"W x 27"D	25 (0420)	12 (0308)	9 (0206)
36"W x 18"D	24 (0518)	8 (0304)	6 (0203)
36"W x 24"D	30 (0524)	12 (0308)	9 (0206)
48"W x 24"D	40 (0732)	15 (0410)	8 (0304)
48"W x 27"D	32 (0724)	15 (0410)	8 (0304)
54"W x 24"D	40 (0930)	18 (0512)	10 (0405)
54"W x 27"D	40 (0930)	18 (0512)	10 (0405)
60"W x 24"D	70 (1356)	24 (0716)	12 (0308)
60"W x 27"D	84 (1370)	21 (0614)	12 (0308)



Always distribute the load evenly to prevent the mobile cabinet from tipping.

## 24" WIDE (W x D x H)

Each model includes two front handles



4 DRAWERS  
R5BCD-2801 24" x 21" x 33 1/8"  
R5BCG-2801 24" x 27" x 33 1/8"



4 DRAWERS  
R5BCD-2803 24" x 21" x 33 1/8"  
R5BCG-2803 24" x 27" x 33 1/8"



3 DRAWERS  
R5BCD-2805 24" x 21" x 33 1/8"  
R5BCG-2805 24" x 27" x 33 1/8"



6 DRAWERS  
R5BCD-3051 24" x 21" x 35 1/8"  
R5BCG-3051 24" x 27" x 35 1/8"



5 DRAWERS  
R5BCD-3053 24" x 21" x 35 1/8"  
R5BCG-3053 24" x 27" x 35 1/8"



5 DRAWERS  
R5BCD-3055 24" x 21" x 35 1/8"  
R5BCG-3055 24" x 27" x 35 1/8"



5 DRAWERS  
R5BCD-3401 24" x 21" x 39 1/8"  
R5BCG-3401 24" x 27" x 39 1/8"



7 DRAWERS  
R5BCD-3851 24" x 21" x 43 1/8"  
R5BCG-3851 24" x 27" x 43 1/8"

## 30" AND 36" WIDE (W x D x H)

Each model includes one side handle



### 1 DRAWER / 1 DOOR / 1 BOTTOM SHELF

R5BDD-2801	30" x 21" x 35 1/2"
R5BDG-2801	30" x 27" x 35 1/2"
R5BEC-2801	36" x 18" x 35 1/2"
R5BEE-2801	36" x 24" x 35 1/2"



### 4 DRAWERS

R5BDD-2803	30" x 21" x 35 1/2"
R5BDG-2803	30" x 27" x 35 1/2"
R5BEC-2803	36" x 18" x 35 1/2"
R5BEE-2803	36" x 24" x 35 1/2"



### 6 DRAWERS

R5BDD-3001	30" x 21" x 37 1/2"
R5BDG-3001	30" x 27" x 37 1/2"
R5BEC-3001	36" x 18" x 37 1/2"
R5BEE-3001	36" x 24" x 37 1/2"



### 5 DRAWERS

R5BDD-3003	30" x 21" x 37 1/2"
R5BDG-3003	30" x 27" x 37 1/2"
R5BEC-3003	36" x 18" x 37 1/2"
R5BEE-3003	36" x 24" x 37 1/2"



### 5 DRAWERS

R5BDD-3005	30" x 21" x 37 1/2"
R5BDG-3005	30" x 27" x 37 1/2"
R5BEC-3005	36" x 18" x 37 1/2"
R5BEE-3005	36" x 24" x 37 1/2"



### 6 DRAWERS

R5BDD-3007	30" x 21" x 37 1/2"
R5BDG-3007	30" x 27" x 37 1/2"
R5BEC-3007	36" x 18" x 37 1/2"
R5BEE-3007	36" x 24" x 37 1/2"



### 4 DRAWERS

R5BDD-3019	30" x 21" x 37 1/2"
R5BDG-3019	30" x 27" x 37 1/2"
R5BEC-3019	36" x 18" x 37 1/2"
R5BEE-3019	36" x 24" x 37 1/2"



### 3 DRAWERS

R5BDD-3021	30" x 21" x 37 1/2"
R5BDG-3021	30" x 27" x 37 1/2"
R5BEC-3021	36" x 18" x 37 1/2"
R5BEE-3021	36" x 24" x 37 1/2"



### 1 ROLL-OUT SHELF / 4 DRAWERS

R5BDD-3015	30" x 21" x 37 1/2"
R5BDG-3015	30" x 27" x 37 1/2"
R5BEC-3015	36" x 18" x 37 1/2"
R5BEE-3015	36" x 24" x 37 1/2"

# PRECONFIGURED MODELS



7 DRAWERS

R5BDD-3801	30" x 21" x 45 1/2"
R5BDG-3801	30" x 27" x 45 1/2"
R5BEC-3801	36" x 18" x 45 1/2"
R5BEE-3801	36" x 24" x 45 1/2"



7 DRAWERS

R5BDD-3803	30" x 21" x 45 1/2"
R5BDG-3803	30" x 27" x 45 1/2"
R5BEC-3803	36" x 18" x 45 1/2"
R5BEE-3803	36" x 24" x 45 1/2"



4 DRAWERS / 1 DOOR / 1 BOTTOM SHELF

R5BDD-3805	30" x 21" x 45 1/2"
R5BDG-3805	30" x 27" x 45 1/2"
R5BEC-3805	36" x 18" x 45 1/2"
R5BEE-3805	36" x 24" x 45 1/2"

## 48" WIDE (W x D x H)

Each model includes one side handle



6 DRAWERS

R5BHE-3001	48" x 24" x 37 1/2"
R5BHG-3001	48" x 27" x 37 1/2"



4 DRAWERS

R5BHE-3019	48" x 24" x 37 1/2"
R5BHG-3019	48" x 27" x 37 1/2"



5 DRAWERS

R5BHE-3009	48" x 24" x 37 1/2"
R5BHG-3009	48" x 27" x 37 1/2"



5 DRAWERS

R5BHE-3011	48" x 24" x 37 1/2"
R5BHG-3011	48" x 27" x 37 1/2"



1 DRAWER / 1 DOUBLE DOOR / 1 BOTTOM SHELF

R5BHE-3013	48" x 24" x 37 1/2"
R5BHG-3013	48" x 27" x 37 1/2"



1 ROLL-OUT SHELF / 4 DRAWERS

R5BHE-3015	48" x 24" x 37 1/2"
R5BHG-3015	48" x 27" x 37 1/2"

## 54" WIDE (W x D x H)

Each model includes one side handle



5 DRAWERS		
R5BJE-3001	54" x 24" x 37½"	
R5BJG-3001	54" x 27" x 37½"	



4 DRAWERS		
R5BJE-3003	54" x 24" x 37½"	
R5BJG-3003	54" x 27" x 37½"	



4 DRAWERS		
R5BJE-3005	54" x 24" x 37½"	
R5BJG-3005	54" x 27" x 37½"	



5 DRAWERS		
R5BJE-3007	54" x 24" x 37½"	
R5BJG-3007	54" x 27" x 37½"	



4 DRAWERS		
R5BJE-3009	54" x 24" x 37½"	
R5BJG-3009	54" x 27" x 37½"	



7 DRAWERS		
R5BJE-3011	54" x 24" x 37½"	
R5BJG-3011	54" x 27" x 37½"	

## 60" WIDE (W x D x H)

Each model includes one side handle



5 DRAWERS		
R5BKE-3023	60" x 24" x 37½"	
R5BKG-3023	60" x 27" x 37½"	



4 DRAWERS		
R5BKE-3025	60" x 24" x 37½"	
R5BKG-3025	60" x 27" x 37½"	



4 DRAWERS		
R5BKE-3027	60" x 24" x 37½"	
R5BKG-3027	60" x 27" x 37½"	



5 DRAWERS		
R5BKE-3029	60" x 24" x 37½"	
R5BKG-3029	60" x 27" x 37½"	



5 DRAWERS		
R5BKE-3031	60" x 24" x 37½"	
R5BKG-3031	60" x 27" x 37½"	



6 DRAWERS		
R5BKE-3033	60" x 24" x 37½"	
R5BKG-3033	60" x 27" x 37½"	

# PRECONFIGURED MODELS

## 48" WIDE (2 x 24"W) AND 60" WIDE (2 x 30"W)

Each model includes one side handle and one brace to join the cabinets



8 DRAWERS		
R5DHG-3011	48" x 27" x 37½"	
R5DKG-3011	60" x 27" x 37½"	



7 DRAWERS		
R5DHG-3013	48" x 27" x 37½"	
R5DKG-3013	60" x 27" x 37½"	



8 DRAWERS / 1 ROLL-OUT SHELF		
R5DHG-3009	48" x 27" x 37½"	
R5DKG-3009	60" x 27" x 37½"	



8 DRAWERS / 1 DOOR / 1 ADJUSTABLE SHELF / 1 BOTTOM SHELF		
R5DHG-3801	48" x 27" x 45½"	
R5DKG-3801	60" x 27" x 45½"	



10 DRAWERS		
R5DHG-3809	48" x 27" x 45½"	
R5DKG-3809	60" x 27" x 45½"	



10 DRAWERS		
R5DHG-3807	48" x 27" x 45½"	
R5DKG-3807	60" x 27" x 45½"	

## SECURITY ACCESSORIES AND RECOMMENDATIONS

### VERTICAL SECURITY BAR

### RB10



- Locks all drawers in a cabinet with a padlock on the right (A) or left (B)
- Safety hasp is located at the top of the bar to facilitate access
- Covers a bank of drawers from 20" to 34" high
- Allows full access to drawers even when installed against a wall
- More than one bar on the same cabinet can be installed (for different users)
- To order: Specify which side the bar is to be installed on, e.g., RB10-24LPA for the right-hand side

PRODUCT NO.	HEIGHT
RB10-20LP_	20"
RB10-24LP_	24"
RB10-26LP_	26"
RB10-30LP_	30"
RB10-34LP_	34"

NOTE: Vertical security bar A is not compatible with a drawer lock.

### TRUE ONE-DRAWER-AT-A-TIME SYSTEM



### RB15



- Prevents multiple drawers from opening at the same time, which ensures the cabinet's stability and users' safety
- To order: Add A to the cabinet product number, e.g., RA30-302738A, see page 50
- To retrofit this mechanism, order an RB15 and specify the number of drawers and roll-out shelves in the cabinet, e.g., RB15-38-07 for a cabinet with seven drawers
- One kit per cabinet



PRODUCT NO.	CABINET HEIGHT
RB15-28-__	28"
RB15-30-__	30"
RB15-34-__	34"
RB15-38-__	38"

## CENTRAL LOCKING SYSTEM

L3



- Locks all drawers and roll-out shelves in the cabinet at the same time
- Drawer and roll-out shelf positions can be reconfigured
- Easy to retrofit
- To order: Add L3 to the cabinet product number, e.g., RA30-302738L3
- For replacement parts or to retrofit this mechanism, order an RB00-DDHHL3



PRODUCT NO.  
L3

## CABINET SAFETY HASP

LP



- Locks all drawers and roll-out shelves in the cabinet at the same time
- Drawer and roll-out shelf positions can be reconfigured
- An alternative to an RB10 Vertical Security Bar
- Easy to retrofit
- To order: Add "LP" to the cabinet product number, e.g., RA30-302738LP
- For replacement parts or to retrofit this mechanism, order an RB00-DDHHL3

PRODUCT NO.  
LP

## ELECTRONIC LOCK FOR CABINET WITH DRAWERS

L50



- Electronically locks all drawers in the cabinet at the same time
- No key required
- Up to 20 different users can be programmed
- 4 to 8 digit access codes
- Simplifies access management to drawers
- To order the complete mechanism with a cabinet with drawers, order an RB00-DDHHL50
- To order as a replacement lock, order an HA48-L50
- One electronic lock system per cabinet. Electronically locks all drawers in the cabinet at the same time



PRODUCT NO.  
L50

## ELECTRONIC LOCK FOR DOORS

L50



- Electronically locks a cabinet door
- No key required
- Up to 20 different users can be programmed
- 4-8 digit access codes
- Compatible with single and double swing doors (RB61, RB62, RB66, and RB67)
- To order: Add L50 to the door product code, e.g. RB61-3620L50



PRODUCT NO.  
L50

## R CABINET BUMPERS

RB9J



- Protects R cabinets from bumps and damage
- Protection kit for all four corners of cabinets
- Vertical bumpers and endcaps made from resistant soft PVC
- Quick and easy installation with double-sided adhesive tape
- Tool-free installation
- To order: Specify the housing height required, e.g., RB9J-30 02 for installation on a 30"H R cabinet and an RD01 side housing

PRODUCT NO.	COMPATIBLE WITH
RB9J-__ 01	RA30 cabinet
RB9J-__ 02	RA30 cabinet and RD01 side housing
RB9J-__ 03	RA30 cabinet and 1 RC02/RC04 side panel
RB9J-__ 04	RA30 cabinet and 2 RC02/RC04 side panels

## SECURITY PANEL

RF91



- Blocks access between two drawers with locks
- Usable space in the cabinet is reduced by 1"
- Installs between two drawers
- Divides the cabinet up for use by more than one user
- To order: Specify the width and depth required, e.g., RF91-36 24 for a 36"W x 24"D panel

PRODUCT NO.  
RF91-\_\_ \_\_

NOTES: Not compatible with RB10 vertical security bars.  
Not compatible with RC00 foldaway shelves.  
Not compatible with RB75 and RB76 doors with frame.

# ACCESSORIES

## CABINET TOPS

### STEEL TOP WITH RUBBER MAT

RC32



- ½"-thick non-slip neoprene surface
- Includes edges on the sides and back
- Height: 1"

### LAMINATED HARDWOOD TOP

WS14



- Top for general industrial applications
- Made from varnished hardwood slats
- Includes a 90° radius front edge for extra comfort
- High impact resistance
- Attractive appearance
- Thickness: 1¾"

### STAINLESS STEEL TOP

RC35



- 16ga stainless steel: RC35-WWDD
- 12ga stainless steel: RC35-WWDD-12
- Acts as a work surface and protects the cabinet from impacts
- Particle board top with stainless steel cover (#4 brushed finish)
- Excellent corrosion and chemical resistance
- Top complies with CARB regulations on formaldehyde emissions
- Includes welded corners for an attractive appearance
- Thickness: 1¾"
- To order a 12ga stainless steel top, add 12 to the product number

### MARINE EDGE STAINLESS STEEL TOP

RC35



- Marine edge 16ga stainless steel: RC35-WWDD-16M
- Marine edge 12ga stainless steel: RC35-WWDD-12M
- Prevents small objects or liquids from falling or spilling from the work surface
- Acts as a work surface and protects the cabinet from impacts
- Particle board top with stainless steel cover (#4 brushed finish)
- Excellent corrosion and chemical resistance
- Top complies with CARB regulations on formaldehyde emissions
- Includes welded corners for an attractive appearance
- Thickness: 1¾"
- To order: Specify the steel gauge required, e.g., RC35-WWDD-16M for a marine edge 16ga stainless steel top

### PAINTED STEEL TOP

RC37



- Acts as a work surface and protects the cabinet from impacts
- Particle board top with painted steel cover
- Top complies with CARB regulations on formaldehyde emissions
- Includes welded corners for an attractive appearance
- Thickness: 1¾"

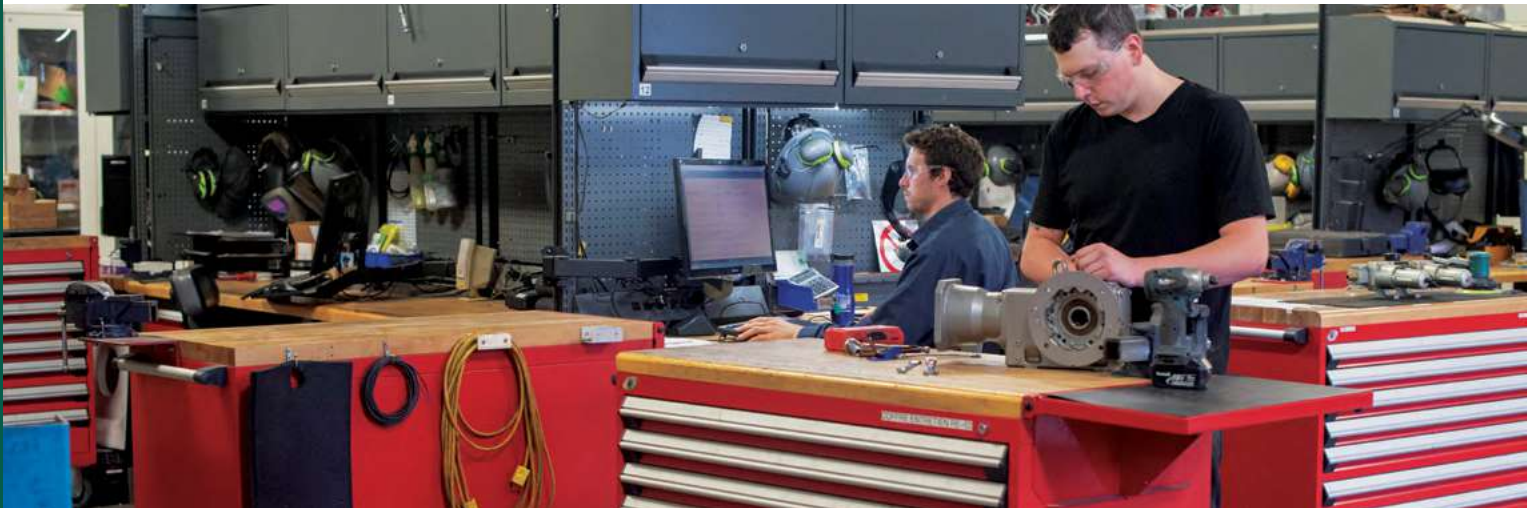



DIMENSIONS		TYPE OF TOP				
W	D	STEEL TOP WITH RUBBER MAT	LAMINATED HARDWOOD*	STAINLESS STEEL	MARINE EDGE STAINLESS STEEL TOP*	PAINTED STEEL
24"	21"	RC32-2421-01	WS14-2421A	RC35-2421-__**		
	27"	RC32-2427-01	WS14-2427A	RC35-2427-__		
30"	21"	RC32-3021-01	WS14-3021A	RC35-3021-__**		
	27"	RC32-3027-01	WS14-3027A	RC35-3027-__	RC35-3027-__M	RC37-3027
36"	18"	RC32-3618-01	WS14-3618A			RC37-3618
	24"	RC32-3624-01	WS14-3624A	RC35-3624-__	RC35-3624-__M	RC37-3624
48"	24"	RC32-4824-01	WS14-4824A	RC35-4824-__	RC35-4824-__M	RC37-4824
	27"	RC32-4827-01	WS14-4827A	RC35-4827-__	RC35-4827-__M	RC37-4827
54"	24"	RC32-5424-01	WS14-5424A	RC35-5424-__**	RC35-5424-__M	RC37-5424
	27"	RC32-5427-01	WS14-5427A	RC35-5427-__**	RC35-5427-__M	RC37-5427
60"	24"	RC32-6024-01	WS14-6024A	RC35-6024-__	RC35-6024-__M	RC37-6024
	27"	RC32-6027-01	WS14-6027A	RC35-6027-__	RC35-6027-__M	RC37-6027
66"	24"	RC32-6624-01	WS14-6624A	RC35-6624-__	RC35-6624-__M	RC37-6624
	27"	RC32-6627-01	WS14-6627A	RC35-6627-__	RC35-6627-__M	RC37-6627
72"	24"	RC32-7224-01	WS14-7224A	RC35-7224-__	RC35-7224-__M	RC37-7224
	27"	RC32-7227-01	WS14-7227A	RC35-7227-__	RC35-7227-__M	RC37-7227
78"	24"	RC32-7824-01	WS14-7824A	RC35-7824-__	RC35-7824-__M	RC37-7824
	27"	RC32-7827-01	WS14-7827A	RC35-7827-__	RC35-7827-__M	RC37-7827

NOTES: \* Please check with your Customer Service representative for lead times.

\*\*16ga only

For compatibility with doors with frame, choose a top 3" deeper than your cabinet, e.g., 27"D cabinet + door with 3"D frame = 30"D top

## TOPS ACCESSORIES

### FOLDAWAY SHELF

RC00



- Load capacity: 50lb. (evenly distributed)
- Includes a protective rubber surface
- Compatible with optional RC01 side and back stops for foldaway shelf

PRODUCT NO.	W x D
RC00-151801	15" x 18"
RC00-152101	15" x 21"
RC00-152401	15" x 24"
RC00-152701	15" x 27"

### SIDE OR BACK STOPS FOR FOLDAWAY SHELF

RC01



- Use the 15" stop for front or back of shelf
- Use the 18", 21", 24" or 27" stop for the sides
- Height: 1"

PRODUCT NO.	WIDTH
RC01-15	15"
RC01-18	18"
RC01-21	21"
RC01-24	24"
RC01-27	27"

### BACK OR SIDE STOPS

WS18 / WS98



- Painted steel: WS18
- Stainless steel: WS98
- Can be installed on back or sides depending on top dimensions
- Installs on WS14 and RC37 tops
- Height: 5". Clears top by approx. 3¼"
- To order: Add the type of steel required to the product number

PRODUCT NO.	WIDTH
WS__-2405	24"
WS__-2705	27"
WS__-3005	30"
WS__-3605	36"
WS__-4205	42"
WS__-4805	48"
WS__-5405	54"
WS__-6005	60"
WS__-7205	72"

NOTE: Not compatible with RC32 and RC35 tops.

## HANGING SIDE CABINETS

### HANGING SIDE CABINET - SIDE ACCESS

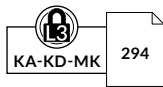

- Side housing specifically designed to be installed on the side of RA30 cabinets
- Includes one bottom shelf
- The shelves are adjustable in 1" increments c/c
- The shelves are compatible with SH52 Partial Dividers
- Includes holes on the top so a common work surface can be installed on the main RA30 cabinet
- Door opens 180° for full access to items stored inside
- Door includes a standard lock
- 600lb. load capacity
- Choice of doors. Add one of the following to the product number:
  - 01: Solid door
  - 02: Polycarbonate door

HEIGHT	WIDTH×DEPTH		NO. OF ADJUSTABLE SHELVES (RD05)
	24"W×14"D	27"W×14"D	
24"	R5QCA-24__	R5QPA-24__	-
28"	R5QCA-28__	R5QPA-28__	1
30"	R5QCA-30__	R5QPA-30__	1
34"	R5QCA-34__	R5QPA-34__	1
38"	R5QCA-38__	R5QPA-38__	2
For Cabinet	24"D	27"D	



R5XHE-1001

NOTE: For compatibility with a work surface, choose a top 12" wider than your cabinet, e.g., RC\_\_-4824 for a 36"W×24"D mobile cabinet

### HANGING SIDE CABINET - FRONT ACCESS



- Side housing specifically designed to be installed on the side of RA30 cabinets
- The shelves are adjustable in 1" increments c/c
- The adjustable and bottom shelves are compatible with SH52 Partial Dividers
- Roll-out shelf: 175lb. load capacity, 75% extension
- Includes holes on the top so a common work surface can be installed on the main RA30 cabinet
- Door opens 180° for full access to items stored inside
- Door includes a standard lock
- 500lb. load capacity
- Choice of configurations. Add one of the following to the product number:
  - Bottom shelf (RB23) and adjustable shelves (RB20):
    - 03: Solid door
    - 05: Polycarbonate door
  - Roll-out shelves (RF55):
    - 04: Solid door
    - 06: Polycarbonate door

HEIGHT	WIDTH×DEPTH				NO. OF ADJUSTABLE SHELVES (RB20)	NO. OF ROLL-OUT SHELVES (RF55)
	24"W×18"D	24"W×21"D	24"W×24"D	24"W×27"D		
28"	R5QCC-28__	R5QCD-28__	R5QCE-28__	R5QCG-28__	1	2
30"	R5QCC-30__	R5QCD-30__	R5QCE-30__	R5QCG-30__	1	2
34"	R5QCC-34__	R5QCD-34__	R5QCE-34__	R5QCG-34__	1	2
38"	R5QCC-38__	R5QCD-38__	R5QCE-38__	R5QCG-38__	2	3
For Cabinet	18"D	21"D	24"D	27"D		



It is recommended to install this product on a 48"W cabinet or wider

NOTE: For compatibility with a work surface, choose a top 24" wider than your cabinet, e.g., RC\_\_-7224 for a 48"W×24"D mobile cabinet

## SIDE PANELS

### SIDE UTILITY PANEL

RC02

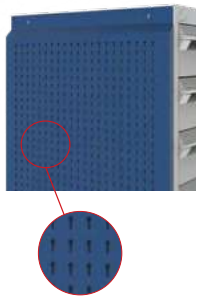

- 5S storage accessory
- Maximizes the cabinet's storage space
- Installs on the sides of R cabinets
- Quick and easy installation
- Includes perforations spaced 1" apart c/c for hanging a range of hooks
- Load capacity: 50lb./sq. ft., 500lb. max. per panel
- Compatible with WM9F, WM9G, WM9H, WM9J and WM9L light-duty hooks, and WM9A and WM9B heavy-duty hooks
- Compatible with WMQ9 tool holders, WM9C bin rails, WM9D can holders, WM9M and WM9N hooks, WM9P spool and roll holders, and WM21 shelves
- Available in all standard R cabinet dimensions (depth, height)
- To order: Specify the housing height required, e.g., RC02-2434 for a 24"D x 34"H housing

PRODUCT NO.	CABINET DEPTH	NO. OF HOLES
RC02-18 __	18"	15
RC02-21 __	21"	18
RC02-24 __	24"	21
RC02-27 __	27"	24

NOTE: Full height installation only.

### SIDE PANEL FOR PLASTIC BINS

RC04

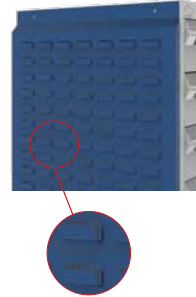

- 5S storage accessory
- Maximizes the cabinet's storage space
- Installs on the sides of R cabinets
- Quick and easy installation
- Holds RG20 plastic bins
- Compatible with all commercially available brands of plastic bins with a hanging lip
- Available in all standard R cabinet dimensions (depth, height)
- To order: Specify the housing height required: RC04-2434 for a 24"D x 34"H housing

PRODUCT NO.	CABINET DEPTH
RC04-18 __	18"
RC04-21 __	21"
RC04-24 __	24"
RC04-27 __	27"

NOTE: Full height installation only.

## AVAILABLE COMBINATIONS

To find the right combination for your intended usage, ask yourself:

How wide do I want the cabinet and what load capacity do I need? Here are the different options available:

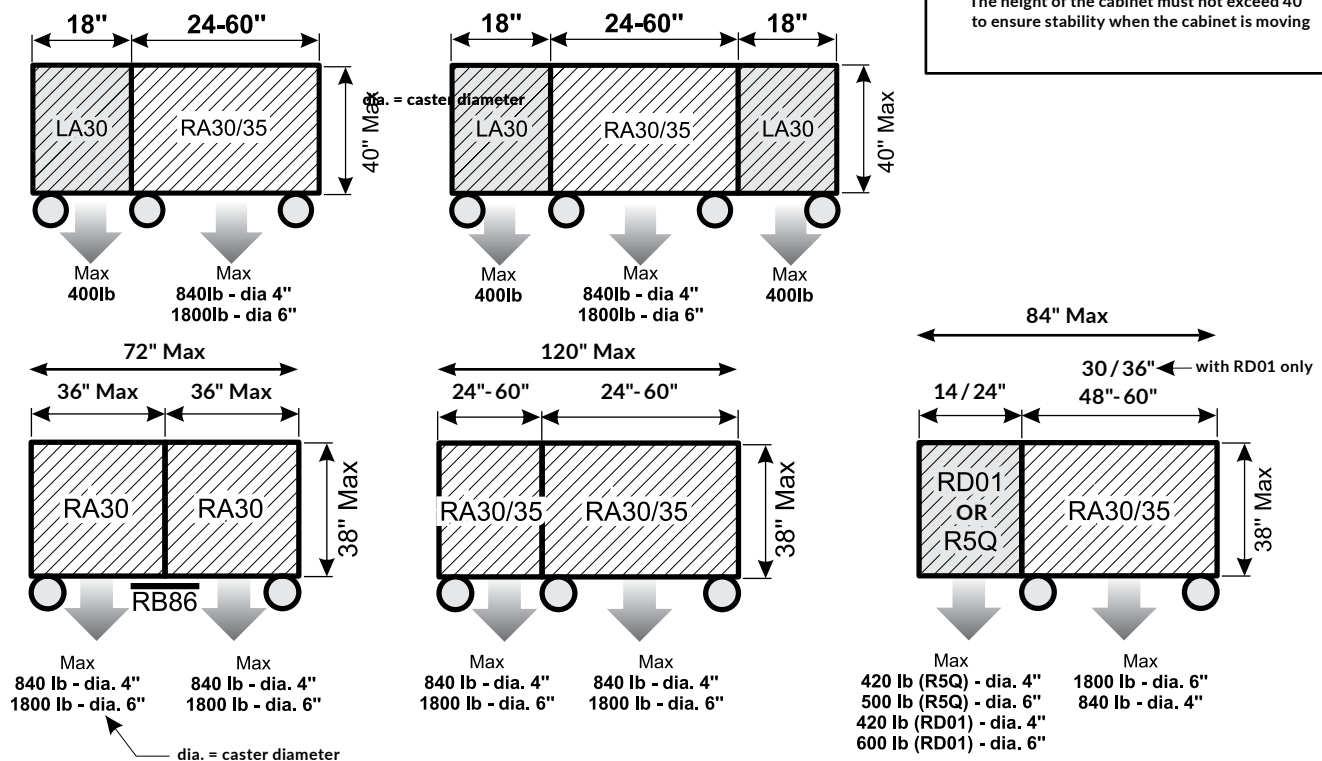

### HOUSINGS

#### R HEAVY-DUTY CABINET HOUSING

RA30

- Compatible with modular drawers, roll-out shelves, adjustable shelves and bottom shelves
- Compatible with integrated doors
- The housing units include knockouts:
  - on the top for installing accessories or work surfaces
  - on the sides and back for installing accessories
- To order a central locking system, add L3 to the product number, [see page 45](#)

- To order a safety hasp, add LP to the product number, [see page 45](#)
- For factory installation of an electronic lock, order an RB00-DDHHL50, [see page 45](#)
- To order a true One-Drawer-at-a-Time mechanism, add A to the product number

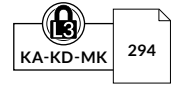

24" and 30" Wide

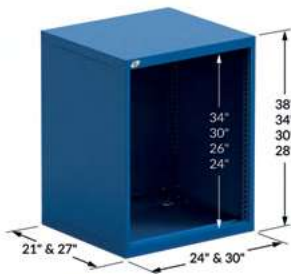

36" Wide

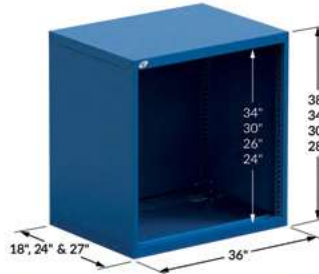

48", 54" and 60" Wide

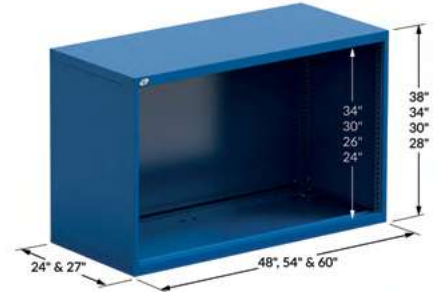

PRODUCT NO.	TOTAL HEIGHT	INSIDE HEIGHT
<b>24" x 21"</b>		
RA30-242124__	24"	20"
RA30-242128__	28"	24"
RA30-242130__	30"	26"
RA30-242134__	34"	30"
RA30-242138__	38"	34"
<b>24" x 27"</b>		
RA30-242724__	24"	20"
RA30-242728__	28"	24"
RA30-242730__	30"	26"
RA30-242734__	34"	30"
RA30-242738__	38"	34"
<b>30" x 21"</b>		
RA30-302124__	24"	20"
RA30-302128__	28"	24"
RA30-302130__	30"	26"
RA30-302134__	34"	30"
RA30-302138__	38"	34"
<b>30" x 27"</b>		
RA30-302724__	24"	20"
RA30-302728__	28"	24"
RA30-302730__	30"	26"
RA30-302734__	34"	30"
RA30-302738__	38"	34"
<b>36" x 18"</b>		
RA30-361824__	24"	20"
RA30-361828__	28"	24"
RA30-361830__	30"	26"
RA30-361834__	34"	30"
RA30-361838__	38"	34"
<b>36" x 24"</b>		
RA30-362424__	24"	20"
RA30-362428__	28"	24"
RA30-362430__	30"	26"
RA30-362434__	34"	30"
RA30-362438__	38"	34"

PRODUCT NO.	TOTAL HEIGHT	INSIDE HEIGHT
<b>36" x 27"</b>		
RA30-362724__	24"	20"
RA30-362728__	28"	24"
RA30-362730__	30"	26"
RA30-362734__	34"	30"
RA30-362738__	38"	34"
<b>48" x 24"</b>		
RA30-482424__	24"	20"
RA30-482428__	28"	24"
RA30-482430__	30"	26"
RA30-482434__	34"	30"
RA30-482438__	38"	34"
<b>48" x 27"</b>		
RA30-482724__	24"	20"
RA30-482728__	28"	24"
RA30-482730__	30"	26"
RA30-482734__	34"	30"
RA30-482738__	38"	34"
<b>54" x 24"</b>		
RA30-542424__	24"	20"
RA30-542428__	28"	24"
RA30-542430__	30"	26"
RA30-542434__	34"	30"
RA30-542438__	38"	34"

PRODUCT NO.	TOTAL HEIGHT	INSIDE HEIGHT
<b>54" x 27"</b>		
RA30-542724__	24"	20"
RA30-542728__	28"	24"
RA30-542730__	30"	26"
RA30-542734__	34"	30"
RA30-542738__	38"	34"
<b>60" x 24"</b>		
RA30-602424__	24"	20"
RA30-602428__	28"	24"
RA30-602430__	30"	26"
RA30-602434__	34"	30"
RA30-602438__	38"	34"
<b>60" x 27"</b>		
RA30-602724__	24"	20"
RA30-602728__	28"	24"
RA30-602730__	30"	26"
RA30-602734__	34"	30"
RA30-602738__	38"	34"

#### BRACES FOR DOUBLE MOBILE CABINET

RB86



- Sold in pairs
- For attaching two housings together (36"W or smaller) to create a double mobile cabinet
- All cabinet tops are compatible with double cabinets, [see page 46](#)
- Cabinets are factory assembled

PRODUCT NO.  
RB86-01

## DOORS

### SINGLE INTEGRATED DOOR, SOLID OR POLYCARBONATE



RB62 / RB61



- Integrated door: RB62
- Polycarbonate integrated door: RB61
- Single door for 18"W, 24"W, 30"W and 36"W cabinets
- RB62 integrated doors have a finished back for increased rigidity and aesthetics
- RB61 integrated polycarbonate doors have excellent impact resistance
- Integrated doors are adjustable vertically and horizontally
- Compatible with RB23/RB25 Bottom Shelf and RB21/RB20 Adjustable Shelf
- Opens 180° for full access to items stored inside
- Factory installed on RA30 cabinet housings
- Some integrated door heights can be combined with drawers mounted above or below. For the latter case, you must order an RB20/RB21 Adjustable Shelf and install it above the bank of drawers
- Three types of lock available: L3 for a standard central lock, LP for a safety hasp or L50 for an electronic lock
- To order: Specify the type of door and lock required, e.g., RB61-3034L50 for a 30"W x 34"H integrated polycarbonate door and L50 electronic lock
- To replace the lock on a single integrated solid or polycarbonate door with an electronic lock, order an: RY50-L50

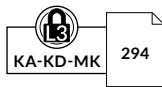

PRODUCT NO.	W x H
RB_-2420_	24" x 20"
RB_-2424_	24" x 24"
RB_-2426_	24" x 26"
RB_-2430_	24" x 30"
RB_-2434_	24" x 34"
RB_-3020_	30" x 20"
RB_-3024_	30" x 24"
RB_-3026_	30" x 26"
RB_-3030_	30" x 30"
RB_-3034_	30" x 34"

PRODUCT NO.	W x H
RB_-3620_	36" x 20"
RB_-3624_	36" x 24"
RB_-3626_	36" x 26"
RB_-3630_	36" x 30"
RB_-3634_	36" x 34"

NOTE: Not compatible with RF31/RF35 drawers or RF40/RF44 roll-out shelves.

### DOUBLE INTEGRATED DOORS, SOLID OR POLYCARBONATE



RB67 / RB66

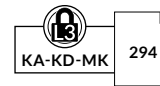

- Integrated door: RB67
- Polycarbonate integrated door: RB66
- Double doors for 30"W, 36"W, 48"W, 54"W and 60"W cabinets
- RB67 integrated doors have a finished back for increased rigidity and aesthetics
- RB66 double integrated polycarbonate doors have excellent impact resistance
- Integrated doors are adjustable vertically and horizontally
- Compatible with RB21 Adjustable Shelf
- Opens 180° for full access to items stored inside
- Factory installed on RA30 cabinet housings
- Some integrated door heights can be combined with drawers mounted above or below. You must order an RB20 / RB21 Adjustable Shelf and install it above the bank of drawers for drawers mounted below, or an RB65 crossbar for drawers mounted above
- Three types of lock available: L3 for a standard central lock, LP for a safety hasp or L50 for an electronic lock
- To order: Specify the type of door and lock required, e.g., RB66-4820L3 for 48"W x 20"H double integrated polycarbonate doors and a standard central lock
- To replace the lock on double integrated solid or polycarbonate doors with an electronic lock, order an: RY51-L50

PRODUCT NO.	W x H
RB_-3020_	30" x 20"
RB_-3024_	30" x 24"
RB_-3026_	30" x 26"
RB_-3030_	30" x 30"
RB_-3034_	30" x 34"
RB_-3040_	30" x 40"
RB_-3054_	30" x 54"
RB_-3620_	36" x 20"
RB_-3624_	36" x 24"
RB_-3626_	36" x 26"
RB_-3630_	36" x 30"
RB_-3634_	36" x 34"
RB_-4820_	48" x 20"
RB_-4824_	48" x 24"
RB_-4826_	48" x 26"
RB_-4830_	48" x 30"

PRODUCT NO.	W x H
RB_-4834_	48" x 34"
RB_-5420_	54" x 20"
RB_-5424_	54" x 24"
RB_-5426_	54" x 26"
RB_-5430_	54" x 30"
RB_-5434_	54" x 34"
RB_-6020_	60" x 20"
RB_-6024_	60" x 24"
RB_-6026_	60" x 26"
RB_-6030_	60" x 30"
RB_-6034_	60" x 34"

NOTES: Not compatible with RF31/RF35 drawers or RF40/RF44 roll-out shelves.  
Not compatible with RB25 Bottom Shelf.

### CROSSBAR FOR DOUBLE INTEGRATED DOORS

RB65



- Required for double integrated doors with drawers above
- Required a crossbar for double integrated doors with an electronic lock and drawers above, complete the following product code: RB65-WWL50

PRODUCT NO.	WIDTH
RB65-30_	30"
RB65-36_	36"
RB65-48_	48"
RB65-54_	54"
RB65-60_	60"

# COMPONENTS

## DRAWERS, SHELVES AND LOCKING / SECURITY MECHANISMS

### HEAVY-DUTY MODULAR DRAWER

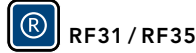

- Painted steel drawer: RF31
- Drawer with stainless steel front and gray painted steel interior: RF35
- 400lb. load capacity, 100% extension
- Heavy-duty construction
- Easy to install
- Vast choice of accessories available to customize the drawer to your storage needs, [see pages 242-247](#)
- Drawer heights available: 3", 4", 5", 6", 7", 8", 9", 10", 12" and 14"
- For preconfigured modular drawers with compartments, [see pages 224-241](#)
- To order: Add the drawer height to the product number, specify the type of drawer front required (painted steel or stainless steel) and the type of lock-in mechanism required, e.g., RF31-362406A



PRODUCT NO.	W x D
RF__-2421__	24" x 21"
RF__-2427__	24" x 27"
RF__-3021__	30" x 21"
RF__-3027__	30" x 27"
RF__-3618__	36" x 18"
RF__-3624__	36" x 24"
RF__-4824__	48" x 24"
RF__-4827__	48" x 27"
RF__-5424__	54" x 24"
RF__-5427__	54" x 27"
RF__-6024__	60" x 24"
RF__-6027__	60" x 27"

### HEAVY-DUTY 3-SIDED ACCESS ROLL-OUT SHELF



- 400lb. load capacity, 100% extension
- Heavy-duty construction
- Easy to install
- Galvanized steel top with 1½"H back
- Total height: 5"
- Can be used as a work surface
- To order: Specify the type of lock-in mechanism required, e.g., RF44-3624A

PRODUCT NO.	W x D
RF44-2421_	24" x 21"
RF44-2427_	24" x 27"
RF44-3021_	30" x 21"
RF44-3027_	30" x 27"
RF44-3618_	36" x 18"
RF44-3624_	36" x 24"
RF44-3627_	36" x 27"

PRODUCT NO.	W x D
RF44-4824_	48" x 24"
RF44-4827_	48" x 27"
RF44-5424_	54" x 24"
RF44-5427_	54" x 27"
RF44-6024_	60" x 24"
RF44-6027_	60" x 27"

### HEAVY-DUTY FRONT ACCESS ROLL-OUT SHELF



- 400lb. load capacity, 100% extension
- Heavy-duty construction
- Easy to install
- Painted steel with 3"H edges on the sides and back
- Total height: 6"
- Full access to contents
- To order: Specify the type of lock-in mechanism required, e.g., RF40-3624A

PRODUCT NO.	W x D
RF40-2421_	24" x 21"
RF40-2427_	24" x 27"
RF40-3021_	30" x 21"
RF40-3027_	30" x 27"
RF40-3618_	36" x 18"
RF40-3624_	36" x 24"
RF40-3627_	36" x 27"

PRODUCT NO.	W x D
RF40-4824_	48" x 24"
RF40-4827_	48" x 27"
RF40-5424_	54" x 24"
RF40-5427_	54" x 27"
RF40-6024_	60" x 24"
RF40-6027_	60" x 27"

### INTEGRATED LOCK-IN MECHANISM

A



- Automatically activated when lifting the handle up
- The drawer or roll-out shelf can be opened with one hand only
- Closes with a simple push
- Stops drawer or roll-out shelf from opening on their own
- Easy to retrofit
- To order: Add **A** to the product number for the drawer, preconfigured compartment layout or roll-out shelf, e.g., RF31-362406A
- For replacement parts or to retrofit this mechanism, order an RY08-WWA

PRODUCT NO.  
A

### ECONO LOCK-IN MECHANISM

B



- Activated with the right hand by sliding the mechanism with thumb
- The drawer or roll-out shelf closes without having to reactivate the slide mechanism
- Stops drawer or roll-out shelf from opening on their own
- Easy to retrofit
- To order: Add **B** to the product number for the drawer, preconfigured compartment layout or roll-out shelf, e.g., RF31-362406B
- For replacement parts or to retrofit this mechanism, order an RY01-B

PRODUCT NO.  
B

## DRAWER LOCK

L3



- Compatible with all drawer dimensions
- Does not reduce the drawer's storage space
- To order: Add **L3** to the product number for the drawer or preconfigured compartment layout, e.g., RF31-362406**L3**
- For replacement parts or to retrofit this mechanism, order an RY01-**L3**

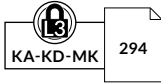

PRODUCT NO. \_\_\_\_\_  
L3 \_\_\_\_\_

## LOCK-OUT MECHANISM

RF85

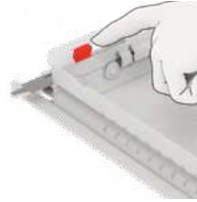

- For both drawers and roll-out shelves
- Locks drawers and roll-out shelves in an open position
- Activated manually, only when required
- Compatible with all drawer accessories

PRODUCT NO. \_\_\_\_\_  
RF85 \_\_\_\_\_

NOTE: Plastic bins in the back row may make it more difficult to activate the mechanism

## ADJUSTABLE SHELF

RB20 / RB21



- For storage of bulky items
- The back and side edges prevent objects from falling to the bottom of the cabinet
- Height can be adjusted in 1" increments c/c
- Up to 400lb. load capacity, evenly distributed
- Includes perforations on the top spaced 3" apart c/c for inserting SH52 Partial Dividers. Allow 3" vertical clearance for installation, [see page 13](#)

PRODUCT NO.	W × D	LOAD CAPACITY (LB.)
RB20-2421	24" × 21"	200
RB20-2427	24" × 27"	200
RB21-3021	30" × 21"	400
RB21-3027	30" × 27"	400
RB21-3618	36" × 18"	400
RB21-3624	36" × 24"	400
RB21-4824	48" × 24"	400
RB21-4827	48" × 27"	400
RB21-5424	54" × 24"	400
RB21-5427	54" × 27"	400
RB21-6024	60" × 24"	400
RB21-6027	60" × 27"	400

NOTE: Actual usable space is 2" c/c less than the height, 2 1/8" c/c less than the width and 4" c/c less than the depth.

## BOTTOM SHELF

RB23 / RB25



- For storage of bulky items
- The back and side edges prevent objects from falling to the bottom of the cabinet
- Up to 400lb. load capacity, evenly distributed
- Includes perforations on the top spaced 3" apart c/c for inserting SH52 Partial Dividers. Allow 3" vertical clearance for installation, [see page 13](#)

PRODUCT NO.	W × D	LOAD CAPACITY (LB.)
RB23-2421	24" × 21"	200
RB23-2427	24" × 27"	200
RB25-3021	30" × 21"	400
RB25-3027	30" × 27"	400
RB25-3618	36" × 18"	400
RB25-3624	36" × 24"	400
RB25-4824	48" × 24"	400
RB25-4827	48" × 27"	400
RB25-5424	54" × 24"	400
RB25-5427	54" × 27"	400
RB25-6024	60" × 24"	400
RB25-6027	60" × 27"	400

NOTES: Actual usable space is 2" c/c less than the height, 2 1/8" c/c less than the width and 4" c/c less than the depth.

For compatibility with double integrated doors or integrated sliding doors, order an adjustable shelf.

# COMPONENTS

## MOBILITY

### CASTERS

### RB81 / RB84 / RB8E



- Sold in pairs
- Three types of casters available: rigid, swivel and swivel with total-lock brake (on wheel and swivel)
- Dark gray, non-marking polyurethane tread
- Superior industrial quality

PRODUCT NO.	CASTER TYPE	CAPACITY	HEIGHT	
			WHEEL	TOTAL
RB81-01	Rigid	440 lb	4"	5 1/8"
RB81-02	Swivel	440 lb	4"	5 1/8"
RB81-03	Swivel with total-lock brake	440 lb	4"	5 1/8"
RB84-01	Rigid	1100 lb	6"	7 1/2"
RB84-02	Swivel	1100 lb	6"	7 1/2"
RB84-03	Swivel with total-lock brake	1100 lb	6"	7 1/2"
RB8E-02	Swivel caster directional locking kit for swivel casters (x2)			

NOTES: The casters install directly under an R cabinet (without base).  
Not compatible with 18"W R cabinets.

### QUIET CASTERS

### RB8C / RB8D



- Sold in pairs
- Smooth and quieter rolling
- Two types of casters available: rigid and swivel with total-lock brake (on wheel and swivel)
- Blue, hard-wearing polyurethane tread for quiet and easy maneuvering
- Superior industrial quality

PRODUCT NO.	CASTER TYPE	CAPACITY	HEIGHT	
			WHEEL	TOTAL
RB8C-01	Quiet, rigid	660 lb	4"	5 1/8"
RB8C-03	Quiet, swivel with total-lock brake	660 lb	4"	5 1/8"
RB8D-01	Quiet, rigid	1100 lb	6"	7 1/2"
RB8D-03	Quiet, swivel with total-lock brake	1100 lb	6"	7 1/2"

NOTES: The casters install directly under an R cabinet (without base).  
Not compatible with 18"W R cabinets.

### EXTENDED BASE FOR CASTERS

### RB88



- Provides stability when the cabinet has fewer than four drawers and/or when the load is not evenly distributed (e.g., One drawer supporting 400lb. and the other three supporting 50lb.)
- Compatible with 4" and 6" casters

PRODUCT NO.	DEPTH
RB88-18-05	18"
RB88-21-05	21"
RB88-24-05	24"
RB88-27-05	27"

### SIDE HANDLE

### RB90



- Installs on the side of single or double cabinets. Specify which side when ordering (left or right)
- Anodized aluminum with heavy-duty plastic end caps
- Wide-grip handle for easier cabinet handling

PRODUCT NO.	HANDLE WIDTH	FOR CABINET
RB90-18	15"	18"D
RB90-21	18"	21"D
RB90-24	21"	24"D
RB90-27	24"	27"D

### FRONT HANDLES

### RB92



- Sold in pairs
- Installs on the front of 24"W and 30"W single cabinets
- Black resistant plastic

PRODUCT NO.
RB92-01

NOTE: Not compatible with the L50 electronic lock system.  
Not compatible with 18"W R cabinets.





## L COMPACT MOBILE CABINET

The innovative L Compact Mobile Cabinet is 18" wide and comes in two depths (21" and 27") and five heights (24", 28", 30", 34" and 40"). It adapts perfectly to your needs and easily integrates into your workspace. Whether you want a single, double or triple unit, it comes mounted on 4" or 6" premium-quality casters, which ensures years of satisfaction from this robust and reliable work equipment.

The L compact drawer has a load capacity of 100lb. and boasts 100% extension in both cabinet depths. There is also a wide range of accessories available for it. The lock-in mechanism allows users to move the cabinet safely, while the central locking mechanism locks all drawers at the same time for secure storage of the drawer contents.

With its intelligent construction and design, the L Compact Mobile Cabinet is versatile, modular and truly ingenious. It is an excellent alternative to the R heavy-duty version.



L3BBD-2803L3B

## THE ROUSSEAU DIFFERENCE



100% extension for both drawer depths, 100lb. load capacity per drawer, six drawer heights available: 3", 4", 5", 6", 8" and 12".



Wide variety of drawer accessories available: full-depth partitions, dividers, plastic bins, hanging file holders, protective foam, etc.



Central locking on the cabinet housing.



The lock-in mechanism stops drawers from opening on their own.



Polyurethane casters for excellent maneuverability without marking floors.



# PRECONFIGURED MODELS

HERE ARE SOME OF OUR MOST POPULAR PRECONFIGURED MODELS OF L COMPACT MOBILE CABINETS

- All preconfigured models are factory assembled and ready to use
- The preconfigured models in this section have 4" casters, including two rigid and two swivel casters with total-lock brakes
- To add a top, [see page 61](#)
- To order a lock on the housing, add **L3** to the end of the product number
- To add an L50 electronic lock to a door or to your L mobile cabinet, [see page 58](#)
- A lock-in mechanism stops drawers from opening on their own when moving the cabinet and when the central locking is not activated
- To order a lock-in mechanism, add **B** to the product number, e.g., L3BBD-2401L3 B for an 18"W×21"D×29 1/4"H cabinet, with three drawers, central lock and lock-in mechanism





**IMPORTANT**

Drawer compartments are included in all models. See the table for the number of compartments

To order drawers without compartments, replace the last two digits of the model number with the next even number up.

e.g., L3BBD-2401 with L3BBD-2402 without



 294











NUMBER OF COMPARTMENTS (LAYOUT CODE)		
DRAWER DIMENSION	18"W×21"D	18"W×27"D
3"H to 5"H	9 (0206)	9 (0206)
6"H and 8"H	6 (0104)	6 (0104)
12"H	4 (0102)	4 (0102)



A security mechanism B on the drawer and/or L3 on the housing is required for all mobile applications.

## 18" WIDE (W × D × H)

Each model includes two front handles

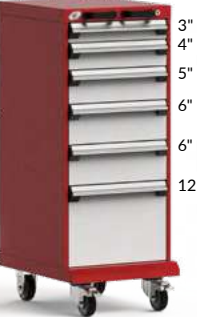
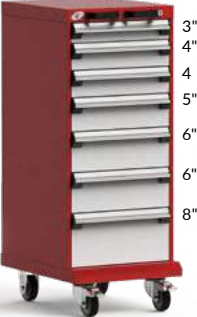
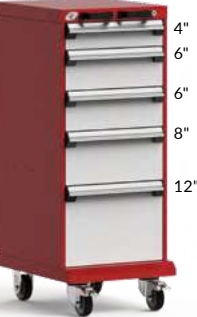
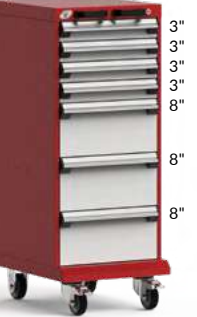
 <p>4" 4" 12"</p>	 <p>6" 6" 8"</p>	 <p>3" 4" 5" 12"</p>	 <p>5" 5" 6" 8"</p>	 <p>3" 3" 5" 5" 5" 5"</p>
<p>3 DRAWERS</p> <p>L3BBD-2401__ 18"×21"×29 1/4"</p> <p>L3BBG-2401__ 18"×27"×29 1/4"</p>	<p>3 DRAWERS</p> <p>L3BBD-2403__ 18"×21"×29 1/4"</p> <p>L3BBG-2403__ 18"×27"×29 1/4"</p>	<p>4 DRAWERS</p> <p>L3BBD-2801__ 18"×21"×33 1/2"</p> <p>L3BBG-2801__ 18"×27"×33 1/2"</p>	<p>4 DRAWERS</p> <p>L3BBD-2803__ 18"×21"×33 1/2"</p> <p>L3BBG-2803__ 18"×27"×33 1/2"</p>	<p>6 DRAWERS</p> <p>L3BBD-3001__ 18"×21"×35 1/8"</p> <p>L3BBG-3001__ 18"×27"×35 1/8"</p>
 <p>3" 3" 4" 6" 6" 8"</p>	 <p>30"</p>	 <p>6" 6" 6" 6" 6"</p>	 <p>4" 4" 6" 8" 8"</p>	 <p>6" 6" 6" 6" 12"</p>
<p>6 DRAWERS</p> <p>L3BBD-3401__ 18"×21"×39 1/4"</p> <p>L3BBG-3401__ 18"×27"×39 1/4"</p>	<p>1 DOOR / 1 SHELF</p> <p>L3BBD-3412__ 18"×21"×39 1/4"</p> <p>L3BBG-3412__ 18"×27"×39 1/4"</p>	<p>5 DRAWERS</p> <p>L3BBD-3413__ 18"×21"×39 1/4"</p> <p>L3BBG-3413__ 18"×27"×39 1/4"</p>	<p>5 DRAWERS</p> <p>L3BBD-3415__ 18"×21"×39 1/4"</p> <p>L3BBG-3415__ 18"×27"×39 1/4"</p>	<p>4 DRAWERS</p> <p>L3BBD-3417__ 18"×21"×39 1/4"</p> <p>L3BBG-3417__ 18"×27"×39 1/4"</p>
 <p>5" 5" 8" 12"</p>	 <p>3" 4" 5" 6" 6" 12"</p>	 <p>3" 4" 4" 5" 6" 6" 6" 8"</p>	 <p>4" 6" 6" 8" 12"</p>	 <p>3" 3" 3" 8" 8" 8"</p>
<p>4 DRAWERS</p> <p>L3BBD-3403__ 18"×21"×39 1/4"</p> <p>L3BBG-3403__ 18"×27"×39 1/4"</p>	<p>6 DRAWERS</p> <p>L3BBD-4001__ 18"×21"×45 1/8"</p> <p>L3BBG-4001__ 18"×27"×45 1/8"</p>	<p>7 DRAWERS</p> <p>L3BBD-4003__ 18"×21"×45 1/8"</p> <p>L3BBG-4003__ 18"×27"×45 1/8"</p>	<p>5 DRAWERS</p> <p>L3BBD-4007__ 18"×21"×45 1/8"</p> <p>L3BBG-4007__ 18"×27"×45 1/8"</p>	<p>7 DRAWERS</p> <p>L3BBD-4009__ 18"×21"×45 1/8"</p> <p>L3BBG-4009__ 18"×27"×45 1/8"</p>

## 36" WIDE (W x D x H)

Each model includes one side handle



9 DRAWERS  
L3BED-2401\_\_ 36" x 21" x 29 1/8"  
L3BEG-2401\_\_ 36" x 27" x 29 1/8"



11 DRAWERS  
L3BED-2801\_\_ 36" x 21" x 33 1/8"  
L3BEG-2801\_\_ 36" x 27" x 33 1/8"



4 DRAWERS / 1 DOOR / 1 SHELF  
L3BED-2823\_\_ 36" x 21" x 33 1/8"  
L3BEG-2823\_\_ 36" x 27" x 33 1/8"



10 DRAWERS  
L3BED-3431\_\_ 36" x 21" x 39 1/8"  
L3BEG-3431\_\_ 36" x 27" x 39 1/8"



9 DRAWERS  
L3BED-3433\_\_ 36" x 21" x 39 1/8"  
L3BEG-3433\_\_ 36" x 27" x 39 1/8"



12 DRAWERS  
L3BED-4001\_\_ 36" x 21" x 45 1/8"  
L3BEG-4001\_\_ 36" x 27" x 45 1/8"



15 DRAWERS  
L3BED-4003\_\_ 36" x 21" x 45 1/8"  
L3BEG-4003\_\_ 36" x 27" x 45 1/8"



4 DRAWERS / 2 DOORS / 2 SHELVES  
L3BED-4033\_\_ 36" x 21" x 45 1/8"  
L3BEG-4033\_\_ 36" x 27" x 45 1/8"

## 54" WIDE (W x D x H)

Each model includes one side handle



12 DRAWERS  
L3BJD-2801\_\_ 54" x 21" x 33 1/8"  
L3BJG-2801\_\_ 54" x 27" x 33 1/8"



13 DRAWERS  
L3BJD-3001\_\_ 54" x 21" x 35 1/8"  
L3BJG-3001\_\_ 54" x 27" x 35 1/8"



16 DRAWERS  
L3BJD-3403\_\_ 54" x 21" x 39 1/8"  
L3BJG-3403\_\_ 54" x 27" x 39 1/8"



15 DRAWERS  
L3BJD-3401\_\_ 54" x 21" x 39 1/8"  
L3BJG-3401\_\_ 54" x 27" x 39 1/8"



18 DRAWERS  
L3BJD-4001\_\_ 54" x 21" x 45 1/8"  
L3BJG-4001\_\_ 54" x 27" x 45 1/8"



8 DRAWERS / 2 DOORS / 2 SHELVES  
L3BJD-4003\_\_ 54" x 21" x 45 1/8"  
L3BJG-4003\_\_ 54" x 27" x 45 1/8"

# ACCESSORIES

## SECURITY MECHANISMS

### ELECTRONIC LOCK SYSTEM FOR CABINET WITH DRAWERS L50



- Electronically locks all drawers in the cabinet at the same time
- No key required
- Up to 20 different users can be programmed
- 4-8 digit access codes
- Simplifies access management to drawers
- To order the complete mechanism with a cabinet with drawers, order an LB00-DDHHL50
- To order as a replacement lock, order an HA52-L50

PRODUCT NO.  
L50

### L50 ELECTRONIC LOCK FOR DOORS L50



- Electronically locks a cabinet door
- No key required
- Up to 20 different users can be programmed
- 4-8 digit access codes
- Compatible with LB30 integrated doors
- To order: Add L50 to the door product code, e.g. LB30-1812L50

PRODUCT NO.  
L50

NOTE: Cannot be retrofitted.

### DRAWER LOCK L3

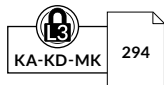

- Two keys provided with each lock
- Compatible with all drawer dimensions
- The mechanism (covered by a galvanized steel box) requires 3"W×1"D space inside the drawer
- To order: Add L3 to the product number for the drawer or preconfigured compartment layout e.g., LF31-182106L3
- For replacement parts or to retrofit this mechanism, order an HA51-L3

PRODUCT NO.  
L3

### CENTRAL LOCKING MECHANISM L3 / LP

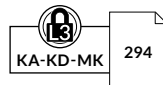

- Locks all drawers in the cabinet at the same time
- Easy to retrofit
- The drawer layout can be changed without touching the locking mechanism
- To order a lock, add L3 to the cabinet housing or preconfigured model number e.g., LA30-182134L3
- To order a safety hasp, add LP to the cabinet housing product number e.g., LA30-182134LP
- For replacement parts or to retrofit this mechanism, order an LB00-DDHH\_\_ and specify the type of lock required

PRODUCT NO.	
L3	Key lock
LP	Safety hasp

NOTE: An LF91 security panel must be ordered to block access between two drawers and if two different user access rights are required.

### DOOR LOCK L3 / LP

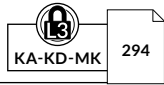

- Two keys provided with each lock
- To order a key lock, add L3 to the door product number e.g., LB30-1812L3
- To order a safety hasp, add LP to the door product number e.g., LB30-1812LP
- For replacement parts or to retrofit this mechanism, order an HA49-L3 or HA49-LP

PRODUCT NO.	
L3	Key lock
LP	Safety hasp

NOTE: An LF91 security panel must be ordered to block access between two doors and if two different user access rights are required.

### LOCK-IN MECHANISM B



- Activated with the right hand by sliding the mechanism with thumb
- The drawer closes without having to reactivate the sliding mechanism
- Stops drawers from opening on their own
- Easy to retrofit
- To order: Add B to the product number for the drawer or preconfigured compartment layout e.g., LF31-182106B
- For replacement parts or to retrofit this mechanism, order an LY01 and a LY02

PRODUCT NO.  
B

## VERTICAL SECURITY BAR

LB10



- Locks all drawers in a cabinet with a key or padlock
- The key or safety hasp is located at the top of the bar to facilitate access
- Covers a bank of drawers from 20" to 36" high
- Easy to assemble
- Installs on the right-hand side
- To order: Specify the type of lock required, LP for a safety hasp or L3 for a standard key lock

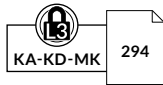

PRODUCT NO.	CABINET HEIGHT	VERTICAL SECURITY BAR HEIGHT
LB10-24_A	24"	20"
LB10-28_A	28"	24"
LB10-30_A	30"	26"
LB10-34_A	34"	30"
LB10-40_A	40"	36"

## SECURITY PANEL

LF91



- Divides the cabinet up for use by more than one user
- Adjustable in 1" increments c/c
- Must be ordered to:
  - Block access between doors
  - Block access when a door with lock is installed under a drawer
  - Block the space left when a door is installed above a drawer
- Two security panel versions available for housings with or without a central locking mechanism
- Galvanized steel
- To order: Specify the housing depth, 21" or 27"

PRODUCT NO.	FOR LA30
LF91-18_01	With L3/LP/L50 on the housing
LF91-18_02	Without L3/LP/L50 on the housing

## DRAWER AND HANDLE ACCESSORIES

### HANDLE PROTECTOR

LF70



- Clips onto the drawer handle
- Made of transparent plastic
- Protects identification labels from dust, grease and dirt
- Easy to remove

PRODUCT NO.
LF70-18

### HANDLE LABELS

LF71



- Labels to be attached to handles under the handle protector (LF70)
- 30 labels per page (10 pages)
- Print your own labels. A template is available on [www.rousseau.com](http://www.rousseau.com) under Information Center > Documents

PRODUCT NO.
LF71-425075

### HANGING FILE BARS

LG31



- For storing hanging files
- Fits both letter and legal sizes
- For 12"H drawers

PRODUCT NO.
LG31-18

### TOOL FOAM

LG42



- Oil resistant and non-absorbent
- Includes one piece of ¼"-thick blue foam
- Includes one piece of ½"-thick black foam
- Sold without cut-outs. Can be cut with a utility knife

PRODUCT NO.	FOR DRAWER
LG42-1821-01	18"W × 21"D
LG42-1827-01	18"W × 27"D

### PVC DRAWER LINER

LG40



- Protects stored objects
- Non-skid surface
- Can be installed under partitions and dividers
- Thickness: 3/32"

PRODUCT NO.	FOR DRAWER
LG40-1821-01	18"W × 21"D
LG40-1827-01	18"W × 27"D

### PROTECTIVE FOAM

LG41



- Protects items stored in the drawer
- Includes one piece of ¼"-thick blue foam

PRODUCT NO.	FOR DRAWER
LG41-1821-01	18"W × 21"D
LG41-1827-01	18"W × 27"D

NOTE: Partitions and dividers cannot be installed in the same drawer as this foam.

# ACCESSORIES

## FRONT TO BACK PARTITION



LG02



- Divides the drawer along its depth
- Clip system locks dividers in place
- Galvanized steel
- Compatible with RG10 dividers, which can be used to make smaller compartments between each partition
- Compatible with plastic bins and PVC drawer liners

NOMINAL DRAWER HEIGHT (ACTUAL)	NOMINAL DRAWER DEPTH (ACTUAL)	
	21" (18")	27" (24")
3" (1 1/8"H)	LG02-2103	LG02-2703
4" (2 3/8"H)	LG02-2104	LG02-2704
5" (3 3/8"H)	LG02-2105	LG02-2705
6" (4 3/8"H)	LG02-2106	LG02-2706
8" (6 3/8"H)	LG02-2108	LG02-2708
12" (8 3/8"H)	LG02-2110	LG02-2710

## PLASTIC BIN



RG20



- For easier storing, moving and managing of small parts
- Lightweight and durable
- For 3"H and 4"H drawers
- 45° angled rim for easy identification of bin contents and removal of bins
- Compatible with partitions and dividers
- 6" plastic bins can be subdivided

DIMENSIONS			PRODUCT NO.		
W	D	H	BIN	PARTITION	DIVIDER
3"	3"	2"	RG20-030302	-	-
4"	3"	2"	RG20-040302	-	-
6"	3"	2"	RG20-060302	RG22-0302	-
6"	6"	2"	RG20-060602	RG22-0602	RG24-0602
3"	3"	3"	RG20-030303	-	-
4"	3"	3"	RG20-040303	-	-
6"	3"	3"	RG20-060303	RG22-0303	-
6"	6"	3"	RG20-060603	RG22-0603	RG24-0603

NOTE: 2"H bins = 1 1/2" actual height  
3"H bins = 2 1/2" actual height

## DRAWER DIVIDER



RG10



- Dividers clip in place
- 45° angled edge for easy identification of compartment contents
- Adjustable in 3" increments (c/c)

NOMINAL DIVIDER WIDTH	NOMINAL DRAWER HEIGHT (ACTUAL)					
	3" (1 1/8"H)	4" (2 3/8"H)	5" (3 3/8"H)	6" (4 3/8"H)	8" (6 3/8"H)	12" (8 3/8"H)
3"	RG10-03003	RG10-03004	RG10-03005	RG10-03006	RG10-03008	RG10-03010
5"	RG10-05003	RG10-05004	RG10-05005	RG10-05006	RG10-05008	RG10-05010
6"	RG10-06003	RG10-06004	RG10-06005	RG10-06006	RG10-06008	RG10-06010
7 1/2"	RG10-07503	RG10-07504	RG10-07505	RG10-07506	RG10-07508	RG10-07510
9"	RG10-09003	RG10-09004	RG10-09005	RG10-09006	RG10-09008	RG10-09010
10"	RG10-10003	RG10-10004	RG10-10005	RG10-10006	RG10-10008	RG10-10010
12"	RG10-12003	RG10-12004	RG10-12005	RG10-12006	RG10-12008	RG10-12010
15"	RG10-15003	RG10-15004	RG10-15005	RG10-15006	RG10-15008	RG10-15010



## CABINET TOPS

### RESISTANT ACRYLIC/PVC PLASTIC LAMINATED TOP WS08



- Ideal for assembly stations or for applications using solvents, oils or other chemical products
- Color: gray
- Premium-quality laminated top
- Excellent chemical resistance (can be in prolonged contact with a substance)
- Superior abrasion resistance compared with standard laminated tops
- Superior impact resistance compared with standard laminated tops
- Attractive appearance
- Thickness: 1½"

### STEEL TOP WITH RUBBER MAT RC32



- Non-slip rubber surface
- Includes edges on the sides and back
- Height: 1"

### STAINLESS STEEL TOP RC35



- Acts as a work surface and protects the cabinet from impacts
- Particle board top with stainless steel cover (#4 brushed finish)
- Excellent corrosion and chemical resistance
- Top complies with CARB regulations on formaldehyde emissions
- Includes welded corners for an attractive appearance
- Thickness: 1¾"

### LAMINATED HARDWOOD TOP WS14



- Top for general industrial applications
- Made from varnished hardwood slats
- Includes a 90° radius front edge for extra comfort
- High impact resistance
- Attractive appearance
- Thickness: 1¾"

### PAINTED STEEL TOP RC37



- Acts as a work surface and protects the cabinet from impacts
- Particle board top with painted steel cover
- Top complies with CARB regulations on formaldehyde emissions
- Includes welded corners for an attractive appearance
- Thickness: 1¾"

### PLASTIC LAMINATED TOP WS16



- Top for general use. Ideal for assembly stations, quality control and packaging
- Color: white
- Attractive appearance
- Easy to clean
- Includes a 90° radius front edge for extra comfort
- Thickness: 1½"

### DISSIPATIVE TOP WS17



- Top for electronics tasks. Ideal for electronics inspection or assembly stations
- Color: white
- Attractive appearance
- Easy to clean
- Includes a 90° radius front edge for extra comfort
- Dissipates electrical charges that can damage electronic components
- The resistance point to point and point to ground is between 10<sup>6</sup> and 10<sup>9</sup>Ω
- Thickness: 1½"

NOTE: Grounding accessories are sold separately, [see page 183](#).

DIMENSIONS		CABINET TOPS						
W	D	ACRYLIC/PVC PLASTIC LAMINATED*	LAMINATED HARDWOOD*	PLASTIC LAMINATED*	DISSIPATIVE*	STEEL TOP WITH RUBBER MAT	STAINLESS STEEL	PAINTED STEEL
18"	21"		WS14-1821A	WS16-1821A		RC32-1821-01	RC35-1821	RC37-1821
	27"		WS14-1827A	WS16-1827A		RC32-1827-01	RC35-1827	RC37-1827
36"	21"	WS08-3621A	WS14-3621A	WS16-3621A	WS17-3621A	RC32-3621-01	RC35-3621	RC37-3621
	27"	WS08-3627A	WS14-3627A	WS16-3627A	WS17-3627A	RC32-3627-01	RC35-3627	RC37-3627
54"	21"	WS08-5421A	WS14-5421A	WS16-5421A	WS17-5421A	RC32-5421-01	RC35-5421	RC37-5421
	27"	WS08-5427A	WS14-5427A	WS16-5427A	WS17-5427A	RC32-5427-01	RC35-5427	RC37-5427

NOTE: \* Please check with your Customer Service representative for lead times.

# ACCESSORIES

## TOP ACCESSORIES

### FOLDAWAY SHELF

RC00



- Load capacity: 50lb. (evenly distributed)
- Includes a protective rubber surface
- Compatible with optional RC01 side and back stops for foldaway shelf

PRODUCT NO.	W×D
RC00-152101	15"×21"
RC00-152701	15"×27"

### SIDE AND BACK STOPS FOR FOLDAWAY SHELF

RC01



- Use the 15" stop for front or back of shelf
- Use the 21" or 27" stop for the sides
- Height: 1"

PRODUCT NO.	WIDTH
RC01-15	15"
RC01-21	21"
RC01-27	27"





## HOUSING AND DOORS

### L COMPACT CABINET HOUSING

LA30

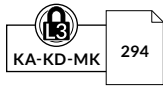

- Create a customized workspace with a wide range of possibilities
- Drawers, shelves and doors can be installed in the housing
- The housing units include knockouts:
  - On the top: for stacking an LD75 Housing for Drawer Unit
  - On the sides: for assembling cabinets side to side
- Requires an LB93 Cart for Single Cabinet for a single mobile cabinet or an LB96 Base for Casters for a double or triple cabinet
- To order a lock on the housing that locks all drawers at the same time, add **L3** to the product number
- To order a safety hasp, add **LP** to the product number
- For factory installation of an electronic lock, order an **LBO0-DDHHL50**

PRODUCT NO.	W × D × H
LA30-182124__	18" × 21" × 24"
LA30-182128__	18" × 21" × 28"
LA30-182130__	18" × 21" × 30"
LA30-182134__	18" × 21" × 34"
LA30-182140__	18" × 21" × 40"
LA30-182724__	18" × 27" × 24"
LA30-182728__	18" × 27" × 28"
LA30-182730__	18" × 27" × 30"
LA30-182734__	18" × 27" × 34"
LA30-182740__	18" × 27" × 40"

### INTEGRATED DOOR

LB30



- Seven standard heights available
- Black plastic recessed handle
- The doors are factory installed with hinges on the left. They can be installed on the right upon request
- An LB24 Adjustable Shelf must be ordered as a storage surface for doors installed above a drawer or another door
- To order a key lock, add **L3** to the product number
- To order a safety hasp, add **LP** to the door product number
- To order an electronic lock for doors, add **L50** to the product number

PRODUCT NO.	W × H
LB30-1812__	18" × 12"
LB30-1818__	18" × 18"
LB30-1820__	18" × 20"
LB30-1824__	18" × 24"
LB30-1826__	18" × 26"
LB30-1830__	18" × 30"
LB30-1836__	18" × 36"

### L COMPACT DRAWER



LF31

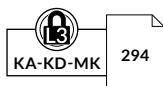
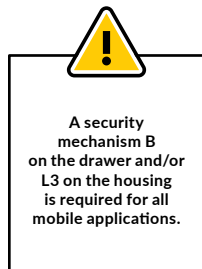

- 100 lb. load capacity, 100% extension
- Vast choice of accessories available to customize the drawer to your storage needs
- Precision ball bearing drawer slides included
- Easy hook-on assembly
- For preconfigured drawer compartment layouts, [see pages 29-30](#)
- Drawer heights available: 3", 4", 5", 6", 8" and 12"
- To order: Add the drawer height required to the product number, e.g., **LF31-182106**
- To order a drawer lock, add **L3** to the drawer product number. The mechanism (covered by a galvanized steel box) requires 3"W × 1"D space inside the drawer e.g., **LF31-182704L3**
- To order a drawer lock-in mechanism, add "B" to the drawer product number, e.g., **LF31-182103B**

PRODUCT NO.	W × D	INSIDE DIM.
LF31-1821__	18" × 21"	15" × 18"
LF31-1827__	18" × 27"	15" × 24"

### ADJUSTABLE SHELF

LB24



- For storage of bulky items
- Includes side and back edges
- Height can be adjusted in 1" increments c/c
- Up to 100lb. load capacity, evenly distributed
- Two adjustable shelf versions available for housings with or without a central locking mechanism
- Galvanized steel
- To order: Specify the housing depth, 21" or 27"

PRODUCT NO.	FOR LA30
LB24-18__01	With L3/LP on the housing
LB24-18__02	Without L3/LP on the housing



## MOBILITY

### CASTERS

LB81 / LB84 / RB8E



PRODUCT NO.	CASTER TYPE	CAPACITY	HEIGHT	
			WHEEL	TOTAL
LB81-01	Rigid	440 lb	4"	5 1/8"
LB81-02	Swivel	440 lb	4"	5 1/8"
LB81-03	Swivel with total-lock brake	440 lb	4"	5 1/8"
LB84-01	Rigid	1100 lb	6"	7 1/2"
LB84-02	Swivel	1100 lb	6"	7 1/2"
LB84-03	Swivel with total-lock brake	1100 lb	6"	7 1/2"
RB8E-02	Swivel caster directional locking kit for swivel casters (x2)			

- Sold in pairs
- Three types of casters available: rigid, swivel and swivel with total-lock brake (on wheel and swivel)
- Dark gray, non-marking polyurethane tread
- Superior industrial quality

NOTE: LB93 Cart for Single Cabinet or LB96 Base for Casters is required for use with an L compact cabinet, [see page 65](#).

### QUIET CASTERS

LB8C / LB8D



PRODUCT NO.	CASTER TYPE	CAPACITY	HEIGHT	
			WHEEL	TOTAL
LB8C-01	Quiet, rigid	660 lb	4"	5 1/8"
LB8C-03	Quiet, swivel with total-lock brake	660 lb	4"	5 1/8"
LB8D-01	Quiet, rigid	1100 lb	6"	7 1/2"
LB8D-03	Quiet, swivel with total-lock brake	1100 lb	6"	7 1/2"

- Sold in pairs
- Smooth and quieter rolling
- Two types of casters available: rigid and swivel with total-lock brake (on wheel and swivel)
- Blue, hard-wearing polyurethane tread for quiet and easy maneuvering
- Superior industrial quality

NOTE: LB93 Cart for Single Cabinet or LB96 Base for Casters is required for use with an L compact cabinet, [see page 65](#).

## CART FOR SINGLE CABINET

LB93



- Required for installing casters under a single cabinet
- Installs under cabinets without a base
- Compatible with 4" and 6" casters (sold separately)

PRODUCT NO.	W×D
LB93-1821	18"×21"
LB93-1827	18"×27"

## BASE FOR CASTERS

LB96



- Required for installing casters under double or triple cabinets
- A base includes two brackets (one front and one rear). Order two bases for a double cabinet and three bases for a triple cabinet
- Installs under cabinets without a base
- Compatible with 4" and 6" casters (sold separately)

PRODUCT NO.
LB96-18



Mobile cabinets must be loaded uniformly to eliminate the risk of tipping when a drawer is opened.

## SIDE HANDLE

RB90



- Installs on the side of double or triple cabinets. Specify which side when ordering (left or right)
- Anodized aluminum with heavy-duty plastic end caps
- Wide-grip handle for easier cabinet handling

PRODUCT NO.	ACTUAL DEPTH	FOR CABINET
RB90-21	18"	21"D
RB90-27	24"	27"D

## FRONT HANDLES

RB92



- Sold in pairs
- Installs on the front of 18"W single cabinets
- Black resistant plastic

PRODUCT NO.
RB92-01

NOTE: Not compatible with the L50 electronic lock system.



# R MULTI-DRAWER CABINET



INDEX	PAGE(S)
R Multi-Drawer Cabinet	66-67
Preconfigured Models – R Mobile Cabinet . . . . .	68 - 70
Preconfigured Models – R Stationary Cabinet . . . . .	71 - 73
Accessories . . . . .	74 - 75

## R MULTI-DRAWER CABINET

For personalized management of your storage space, you will love the stylish design and impressive versatility of our R Multi-Drawer Cabinets. Whether you need just one unit or one hundred, our team will help you build your ideal configuration.

The cabinet is available in both stationary and mobile versions. The mobile version features superior-quality casters, a sturdy handle that provides a firm grip and an integrated lock-in mechanism for added safety when moving the cabinet around the workplace. All mobile and stationary models include a central locking system so all drawers can be locked at the same time, as well as stabilizing bars, which provided extra rigidity to the housing.

The multi-drawer cabinet is incredibly versatile, built to last and available in a wide variety of colors. And we are as proud of it as you will be!



R5XHE-1018



**LIFETIME WARRANTY**  
The Rousseau drawer rolling mechanism is covered by a lifetime warranty.

# R MULTI-DRAWER CABINET

## THE ROUSSEAU ADVANTAGES



The integrated lock-in mechanism activates easily with just one hand (right or left).



The full-width ergonomic handle provides a comfortable grip when opening the drawer.

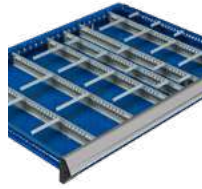

Variety of drawer accessories available: partitions, dividers, plastic bins, protective foam, etc.



Polyurethane casters for excellent maneuverability without marking floors.



Variety of cabinet accessories available: foldaway shelves, storage cabinets, wood tops, etc.



Industry-leading 400lb. load capacity per drawer.

## GENERAL DIMENSIONS

Multi-drawer cabinets are available in different sizes and with different partition options. Contact Customer Service to create your own custom configuration.

WIDTH x DEPTH x HEIGHT

Mobile

Stationary

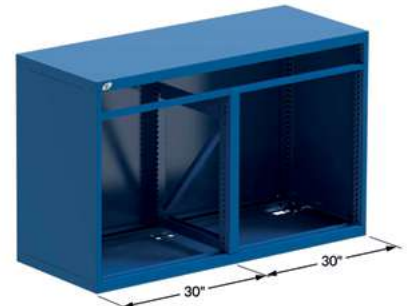
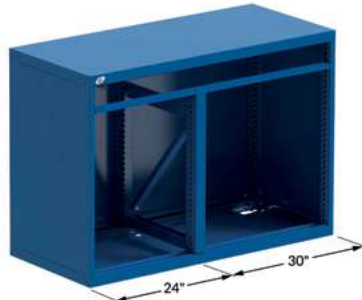
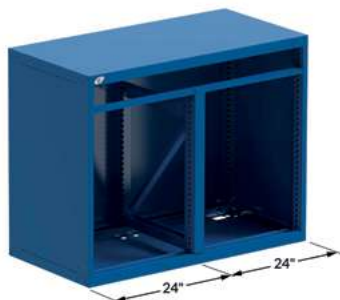
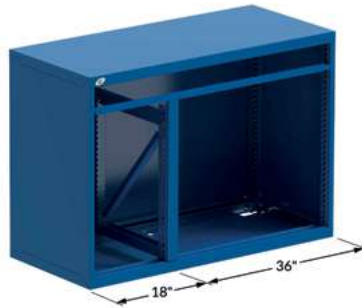
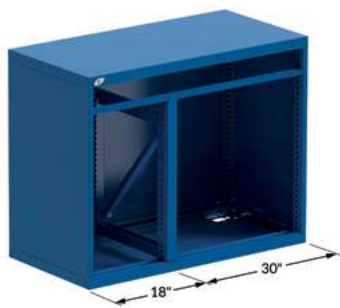
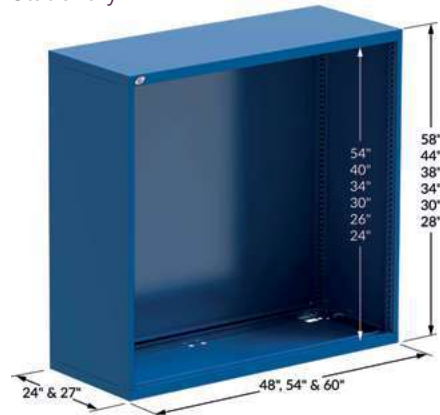
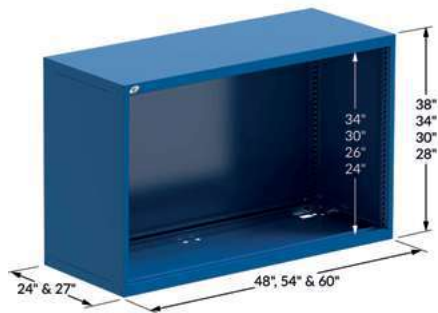

NOTE: The narrower bank of drawers is always installed on the left. e.g., 24"W to the left and 36"W to the right.

# PRECONFIGURED MODELS - R MULTI-DRAWER MOBILE CABINETS

HERE ARE SOME OF OUR MOST POPULAR PRECONFIGURED MODELS OF R MULTI-DRAWER MOBILE CABINETS

- Preconfigured models for multi-drawer mobile cabinets have four 6" casters, including two rigid and two swivel casters with total-lock brakes (superior industrial quality, non-marking polyurethane wheels)
- R Multi-drawer Mobile Cabinets include stabilizing bars to provide extra rigidity to the housing
- All cabinets include a standard cabinet lock (L3) and an integrated lock-in mechanism **A** on each drawer
- All cabinets are fitted with a True One-Drawer-at-a-Time System
- To order a safety hasp **LP**, see page 45, contact Customer Service
- To order an electronic lock **L50**, see page 75, contact Customer Service
- To add a stainless steel, painted steel, steel with rubber mat, wood or marine edge stainless steel top, see page 46
- Each model includes a wide-grip side handle for easier cabinet handling
- Please contact your Customer Service representative for a more personalized configuration



**IMPORTANT**

Drawer compartments are included in all models. See the number of compartments and suggested layouts below.

To order drawers without compartments, replace the last two digits of the model number with the next even number up.

Ex.: R5GHE-3003 with R5GHE-3004 without

KA-KD-MK 294

NUMBER OF COMPARTMENTS (LAYOUT CODE)			
DRAWER DIMENSIONS	3"H TO 5"H	6"H TO 8"H	9"H AND HIGHER
18"W x 24"D	6 (0104)	4 (0102)	2 (0100)
18"W x 27"D	6 (0104)	4 (0102)	2 (0100)
24"W x 24"D	12 (0308)	9 (0206)	6 (0104)
24"W x 27"D	20 (0316)	12 (0209)	6 (0104)
30"W x 24"D	30 (0524)	12 (0308)	9 (0206)
30"W x 27"D	25 (0420)	12 (0308)	9 (0206)
36"W x 24"D	30 (0524)	12 (0308)	9 (0206)
36"W x 27"D	30 (0425)	12 (0308)	6 (0203)
48"W x 24"D	40 (0732)	18 (0512)	8 (0304)
48"W x 27"D	32 (0724)	15 (0410)	8 (0304)
54"W x 24"D	40 (0930)	18 (0512)	10 (0405)
54"W x 27"D	40 (0930)	18 (0512)	10 (0405)
60"W x 24"D	70 (1356)	24 (0716)	12 (0308)
60"W x 27"D	84 (1370)	21 (0614)	12 (0308)

NOTE: For interior drawer dimensions, see pages 226-228.

## 48" WIDE (W x D x H)



To prevent the mobile cabinet from tipping, distribute the load evenly.



12 DRAWERS  
R5GHE-3023 48" x 24" x 37 1/2"  
R5GHG-3023 48" x 27" x 37 1/2"

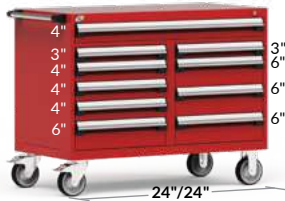

10 DRAWERS  
R5GHE-3005 48" x 24" x 37 1/2"  
R5GHG-3005 48" x 27" x 37 1/2"

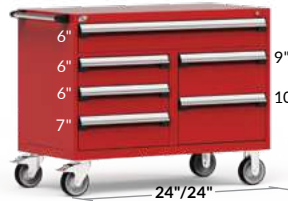

6 DRAWERS  
R5GHE-3019 48" x 24" x 37 1/2"  
R5GHG-3019 48" x 27" x 37 1/2"



9 DRAWERS  
R5GHE-3009 48" x 24" x 37 1/2"  
R5GHG-3009 48" x 27" x 37 1/2"



9 DRAWERS  
R5GHE-3419 48" x 24" x 41 1/2"  
R5GHG-3419 48" x 27" x 41 1/2"



9 DRAWERS  
R5GHE-3415 48" x 24" x 41 1/2"  
R5GHG-3415 48" x 27" x 41 1/2"



11 DRAWERS  
R5GHE-3405 48" x 24" x 41 1/2"  
R5GHG-3405 48" x 27" x 41 1/2"



12 DRAWERS  
R5GHE-3809 48" x 24" x 45 1/2"  
R5GHG-3809 48" x 27" x 45 1/2"



9 DRAWERS  
R5GHE-3835 48" x 24" x 45 1/2"  
R5GHG-3835 48" x 27" x 45 1/2"



10 DRAWERS  
R5GHE-3813 48" x 24" x 45 1/2"  
R5GHG-3813 48" x 27" x 45 1/2"



11 DRAWERS  
R5GHE-3815 48" x 24" x 45 1/2"  
R5GHG-3815 48" x 27" x 45 1/2"



12 DRAWERS  
R5GHE-3817 48" x 24" x 45 1/2"  
R5GHG-3817 48" x 27" x 45 1/2"

# PRECONFIGURED MODELS - R MULTI-DRAWER MOBILE CABINETS

54" WIDE (W x D x H)

R MULTI-DRAWER CABINET



8 DRAWERS

R5GJE-3001 54" x 24" x 37½"

R5GJG-3001 54" x 27" x 37½"



7 DRAWERS

R5GJE-3003 54" x 24" x 37½"

R5GJG-3003 54" x 27" x 37½"



7 DRAWERS

R5GJE-3005 54" x 24" x 37½"

R5GJG-3005 54" x 27" x 37½"



7 DRAWERS

R5GJE-3007 54" x 24" x 37½"

R5GJG-3007 54" x 27" x 37½"



9 DRAWERS

R5GJE-3401 54" x 24" x 41½"

R5GJG-3401 54" x 27" x 41½"



8 DRAWERS

R5GJE-3403 54" x 24" x 41½"

R5GJG-3403 54" x 27" x 41½"



9 DRAWERS

R5GJE-3405 54" x 24" x 41½"

R5GJG-3405 54" x 27" x 41½"



10 DRAWERS

R5GJE-3407 54" x 24" x 41½"

R5GJG-3407 54" x 27" x 41½"



10 DRAWERS

R5GJE-3801 54" x 24" x 45½"

R5GJG-3801 54" x 27" x 45½"



10 DRAWERS

R5GJE-3803 54" x 24" x 45½"

R5GJG-3803 54" x 27" x 45½"



12 DRAWERS

R5GJE-3805 54" x 24" x 45½"

R5GJG-3805 54" x 27" x 45½"



11 DRAWERS

R5GJE-3807 54" x 24" x 45½"

R5GJG-3807 54" x 27" x 45½"

# PRECONFIGURED MODELS - R MULTI-DRAWER MOBILE CABINETS

60" WIDE (W x D x H)



10 DRAWERS  
R5GKE-3005 60" x 24" x 37½"  
R5GKG-3005 60" x 27" x 37½"



7 DRAWERS  
R5GKE-3015 60" x 24" x 37½"  
R5GKG-3015 60" x 27" x 37½"



9 DRAWERS  
R5GKE-3009 60" x 24" x 37½"  
R5GKG-3009 60" x 27" x 37½"



10 DRAWERS  
R5GKE-3403 60" x 24" x 41½"  
R5GKG-3403 60" x 27" x 41½"



11 DRAWERS  
R5GKE-3405 60" x 24" x 41½"  
R5GKG-3405 60" x 27" x 41½"



9 DRAWERS  
R5GKE-3823 60" x 24" x 45½"  
R5GKG-3823 60" x 27" x 45½"



9 DRAWERS  
R5GKE-3825 60" x 24" x 45½"  
R5GKG-3825 60" x 27" x 45½"



10 DRAWERS  
R5GKE-3813 60" x 24" x 45½"  
R5GKG-3813 60" x 27" x 45½"



8 DRAWERS  
R5GKE-3827 60" x 24" x 45½"  
R5GKG-3827 60" x 27" x 45½"





# PRECONFIGURED MODELS - R MULTI-DRAWER STATIONARY CABINETS

HERE ARE SOME OF OUR MOST POPULAR PRECONFIGURED MODELS OF STATIONARY MULTI-DRAWER CABINETS

- Preconfigured models for R Multi-Drawer Stationary Cabinets include a 2" front access forklift base (kick plate included)
- R Multi-Drawer Stationary Cabinets include stabilizing bars to provide extra rigidity to the housing
- To add a stainless steel, painted steel, steel with rubber mat, wood or marine edge stainless steel top, [see page 12](#)
- All cabinets include a standard cabinet lock (L3)
- For a safety hasp (LP), [see page 11](#), contact Customer Service
- For an electronic lock (L50), [see page 75](#), contact Customer Service
- Please contact your Customer Service representative for a more personalized configuration



NOTE: For interior drawer dimensions, [see pages 226-228](#).

## IMPORTANT

Drawer compartments are included in all models. See the number of compartments and suggested layouts below.

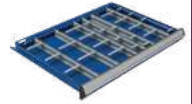

To order drawers without compartments, replace the last two digits of the model number with the next even number up.

Ex.: R5KHE-3005 with R5KHE-3006 without



### NUMBER OF COMPARTMENTS (LAYOUT CODE)

DRAWER DIMENSIONS	3"H TO 5"H	6"H TO 8"H	9"H AND HIGHER
18"W x 24"D	6 (0104)	4 (0102)	2 (0100)
18"W x 27"D	6 (0104)	4 (0102)	2 (0100)
24"W x 24"D	12 (0308)	9 (0206)	6 (0104)
24"W x 27"D	20 (0316)	12 (0209)	6 (0104)
30"W x 24"D	30 (0524)	12 (0308)	9 (0206)
30"W x 27"D	25 (0420)	12 (0308)	9 (0206)
36"W x 24"D	30 (0524)	12 (0308)	9 (0206)
36"W x 27"D	30 (0425)	12 (0308)	6 (0203)
48"W x 24"D	40 (0732)	18 (0512)	8 (0304)
48"W x 27"D	32 (0724)	15 (0410)	8 (0304)
54"W x 24"D	40 (0930)	18 (0512)	10 (0405)
54"W x 27"D	40 (0930)	18 (0512)	10 (0405)
60"W x 24"D	70 (1356)	24 (0716)	12 (0308)
60"W x 27"D	84 (1370)	21 (0614)	12 (0308)

## 48" WIDE (W x D x H)



10 DRAWERS  
R5KHE-3021 48" x 24" x 32"  
R5KHG-3021 48" x 27" x 32"



7 DRAWERS  
R5KHE-3015 48" x 24" x 32"  
R5KHG-3015 48" x 27" x 32"



10 DRAWERS  
R5KHE-3403 48" x 24" x 36"  
R5KHG-3403 48" x 27" x 36"



11 DRAWERS  
R5KHE-3405 48" x 24" x 36"  
R5KHG-3405 48" x 27" x 36"



12 DRAWERS  
R5KHE-3821 48" x 24" x 40"  
R5KHG-3821 48" x 27" x 40"



13 DRAWERS  
R5KHE-3811 48" x 24" x 40"  
R5KHG-3811 48" x 27" x 40"



12 DRAWERS  
R5KHE-3817 48" x 24" x 40"  
R5KHG-3817 48" x 27" x 40"



11 DRAWERS  
R5KHE-4409 48" x 24" x 46"  
R5KHG-4409 48" x 27" x 46"

R MULTI-DRAWER CABINET

# PRECONFIGURED MODELS - R MULTI-DRAWER STATIONARY CABINETS



**9 DRAWERS**  
R5KHE-4415 48" x 24" x 46"  
R5KHG-4415 48" x 27" x 46"



**13 DRAWERS**  
R5KHE-4413 48" x 24" x 46"  
R5KHG-4413 48" x 27" x 46"



**17 DRAWERS**  
R5KHE-5801 48" x 24" x 60"  
R5KHG-5801 48" x 27" x 60"



**11 DRAWERS**  
R5KHE-5809 48" x 24" x 60"  
R5KHG-5809 48" x 27" x 60"

## 54" WIDE (W x D x H)



**8 DRAWERS**  
R5KJE-3001 54" x 24" x 32"  
R5KJG-3001 54" x 27" x 32"



**6 DRAWERS**  
R5KJE-3003 54" x 24" x 32"  
R5KJG-3003 54" x 27" x 32"



**10 DRAWERS**  
R5KJE-3401 54" x 24" x 36"  
R5KJG-3401 54" x 27" x 36"



**9 DRAWERS**  
R5KJE-3403 54" x 24" x 36"  
R5KJG-3403 54" x 27" x 36"



**8 DRAWERS**  
R5KJE-3405 54" x 24" x 36"  
R5KJG-3405 54" x 27" x 36"

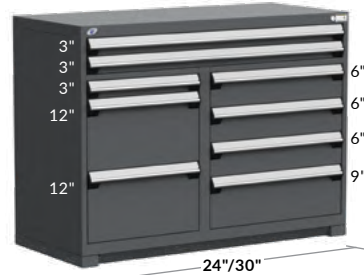

**9 DRAWERS**  
R5KJE-3801 54" x 24" x 40"  
R5KJG-3801 54" x 27" x 40"

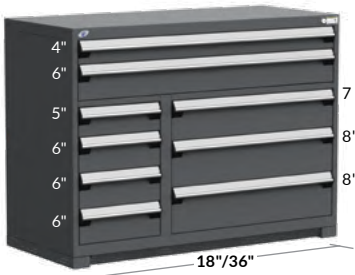

**9 DRAWERS**  
R5KJE-3803 54" x 24" x 40"  
R5KJG-3803 54" x 27" x 40"



**11 DRAWERS**  
R5KJE-4401 54" x 24" x 46"  
R5KJG-4401 54" x 27" x 46"



**12 DRAWERS**  
R5KJE-5801 54" x 24" x 60"  
R5KJG-5801 54" x 27" x 60"

# PRECONFIGURED MODELS - R MULTI-DRAWER STATIONARY CABINETS

60" WIDE (W x D x H)



8 DRAWERS		
R5KKE-3007	60" x 24" x 32"	
R5KKG-3007	60" x 27" x 32"	



10 DRAWERS		
R5KKE-3403	60" x 24" x 36"	
R5KKG-3403	60" x 27" x 36"	



11 DRAWERS		
R5KKE-3405	60" x 24" x 36"	
R5KKG-3405	60" x 27" x 36"	



12 DRAWERS		
R5KKE-3809	60" x 24" x 40"	
R5KKG-3809	60" x 27" x 40"	



10 DRAWERS		
R5KKE-3813	60" x 24" x 40"	
R5KKG-3813	60" x 27" x 40"	

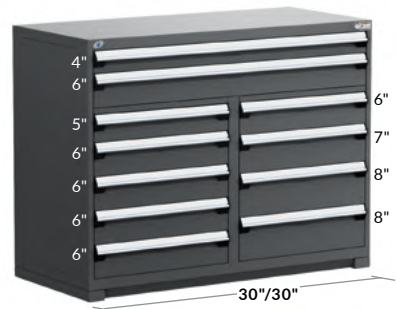

11 DRAWERS		
R5KKE-4405	60" x 24" x 46"	
R5KKG-4405	60" x 27" x 46"	



10 DRAWERS		
R5KKE-4407	60" x 24" x 46"	
R5KKG-4407	60" x 27" x 46"	

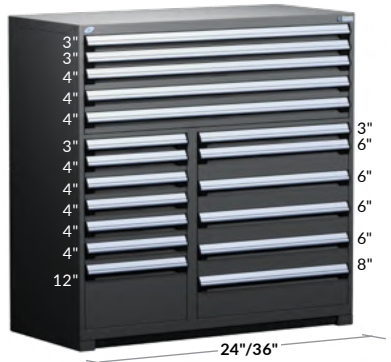

18 DRAWERS		
R5KKE-5813	60" x 24" x 60"	
R5KKG-5813	60" x 27" x 60"	



12 DRAWERS		
R5KKE-5819	60" x 24" x 60"	
R5KKG-5819	60" x 27" x 60"	

# ACCESSORIES

## SIDE PANELS

### SIDE UTILITY PANEL

RC02



- 5S storage accessory
- Maximizes the cabinet's storage space
- Installs on the sides of R cabinets
- Quick and easy installation
- Includes perforations spaced 1" apart c/c for hanging a range of hooks
- Load capacity: 50lb./sq. ft., 500lb. max. per panel
- Compatible with WM9F, WM9G, WM9H, WM9J and WM9L light-duty hooks, and WM9A and WM9B heavy-duty hooks
- Compatible with WMQ9 tool holders, WM9C bin rails, WM9D can holders, WM9M and WM9N hooks, WM9P spool and roll holders, and WM21 shelves
- Available in all standard R cabinet dimensions (depth, height)
- To order: Specify the housing height required, e.g., RC02-2434 for a 24"D x 34"H housing

PRODUCT NO.	CABINET DEPTH	NO. OF HOLES
RC02-18 __	18"	15
RC02-21 __	21"	18
RC02-24 __	24"	21
RC02-27 __	27"	24

NOTE: Full height installation only.

### SIDE PANEL FOR PLASTIC BINS

RC04



- 5S storage accessory
- Maximizes the cabinet's storage space
- Installs on the sides of R cabinets
- Quick and easy installation
- Holds RG20 plastic bins
- Compatible with all commercially available brands of plastic bins with a hanging lip
- Available in all standard R cabinet dimensions (depth, height)
- To order: Specify the housing height required: RC04-2434 for a 24"D x 34"H housing

PRODUCT NO.	CABINET DEPTH
RC04-18 __	18"
RC04-21 __	21"
RC04-24 __	24"
RC04-27 __	27"

NOTE: Full height installation only.



## SECURITY MECHANISMS

### ELECTRONIC LOCK FOR CABINET WITH DRAWERS L50



- Electronically locks all drawers in the cabinet at the same time
- No key required
- Up to 20 different users can be programmed
- 4 to 8 digit access codes
- Simplifies access management to drawers
- To order the complete mechanism with a cabinet with drawers, order an RB01-WWDDHHL50
- To order as a replacement lock, order an HA48-L50
- One electronic lock system per cabinet.

**PRODUCT NO.**  
L50

### ELECTRONIC LOCK FOR DOORS L50



- Electronically locks a cabinet door
- No key required
- Up to 20 different users can be programmed
- 4-8 digit access codes
- Compatible with single, double and polycarbonate swing doors, with or without frame (RB61, RB62, RB66, RB67, RB75 and RB76)
- To order: Add L50 to the door product code, e.g. RB61-3620L50

**PRODUCT NO.**  
L50

### R CABINET BUMPERS RB9J



- Protects R cabinets from bumps and damage
- Protection kit for all four corners of cabinets
- Vertical bumpers and endcaps made from resistant soft PVC
- Quick and easy installation with double-sided adhesive tape
- Tool-free installation
- To order: Specify the housing height required, e.g., RB9J-30 02 for installation on a 30"H R cabinet and an RD01 side housing

PRODUCT NO.	COMPATIBLE WITH
RB9J- _ 01	RA35 cabinet
RB9J- _ 02	RA35 cabinet and RD01 side housing
RB9J- _ 03	RA35 cabinet and 1 RC02 / RC04 utility panel
RB9J- _ 04	RA35 cabinet and 2 RC02 / RC04 utility panels

NOTES: Not compatible with RB10 vertical security bars.  
Not compatible with RC00 foldaway shelves.  
Not compatible with RB75 and RB76 doors with frame.

### VERTICAL SECURITY BAR RB10



- Two vertical bars are required on a multi-drawer cabinet, one on the right-hand side of the cabinet and one on the left
- Covers a bank of drawers from 18" to 54" high
- Allows full access to drawers even when installed against a wall
- Order two vertical security bars corresponding to the internal height of the cabinet, e.g., 54" bars for a 58"H cabinet
- To order, add A to the product number for the right bar and B for the left bar

PRODUCT NO.	HEIGHT
RB10-18LP_	18"
RB10-20LP_	20"
RB10-24LP_	24"
RB10-26LP_	26"
RB10-30LP_	30"
RB10-34LP_	34"
RB10-36LP_	36"
RB10-40LP_	40"
RB10-54LP_	54"

NOTE: The vertical security bar cannot be installed on the central partition.



INDEX	PAGE(S)
R2V Vertical Storage	76-79
Preconfigured Models . . . . .	79-82
Accessories . . . . .	83
Components . . . . .	84-85

## R2V VERTICAL STORAGE

The R2V Vertical Storage System is the only product of its type on the market. Stacked above an R cabinet (sold separately), it is ideal for storing more items and equipment while keeping them within easy reach. By using all vertical space available, you can free up floor space and stay perfectly organized.

The drawers – which are fitted with a lock-in mechanism – open to full extension and boast a 200lb. load capacity. They provide high-density and tidy storage, which helps boost your productivity and efficiency.





**LIFETIME WARRANTY**

The Rousseau drawer rolling mechanism is covered by a lifetime warranty.



RL-5HDG34004N

## THE ROUSSEAU DIFFERENCE

### DRAWER INTERIOR

Pale-gray color for better visibility

### ORGANIZATION

Front and back inner panels with perforations for hanging tools. Optional utility panels and a range of 55 accessories also available

### LOCKS

Standard lock included on all models. Optional electronic lock and two-user lock also available



### ONE-DRAWER-AT-A-TIME SYSTEM

Available as an option

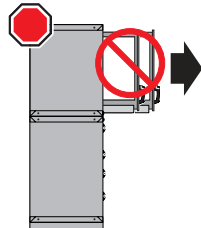

### SECURE



### ADJUSTABLE TRAY

Ideal for storing different tools and products. Easy tool-free repositioning in one inch increments



### PVC DRAWER LINER



### PLASTIC BINS



HEAVY-DUTY, COMFORTABLE AND ERGONOMIC HANDLE

### LOAD CAPACITY

200lb. load capacity per drawer



### MAGNETIC DIVIDER

Easy to reposition. Front-to-back and left-to-right dividers available

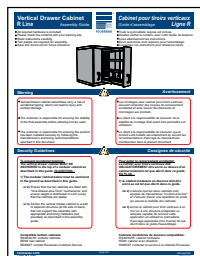

# R2V VERTICAL STORAGE

## GENERAL DIMENSIONS



## VERTICAL DRAWER DIMENSIONS

### 24" D DRAWERS

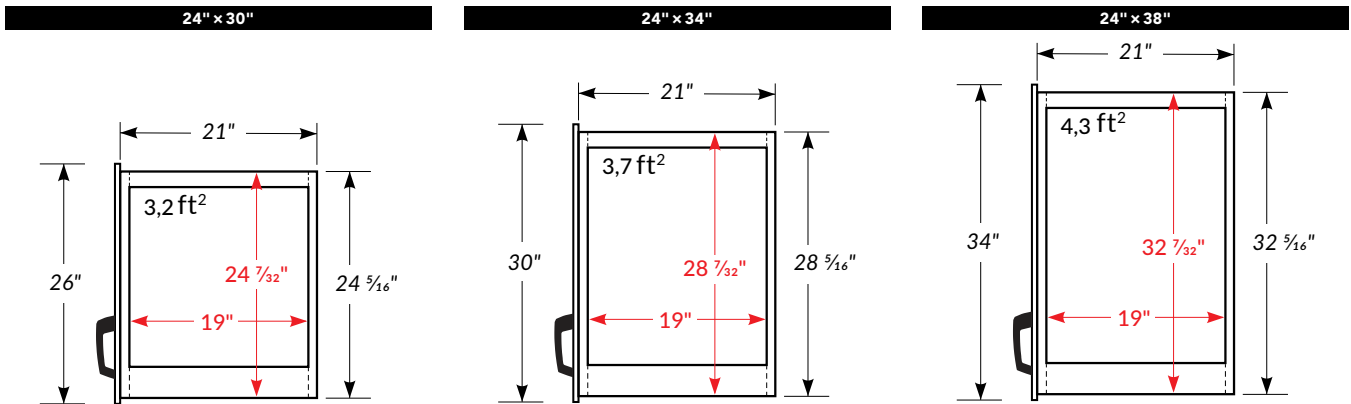

### 27" D DRAWERS

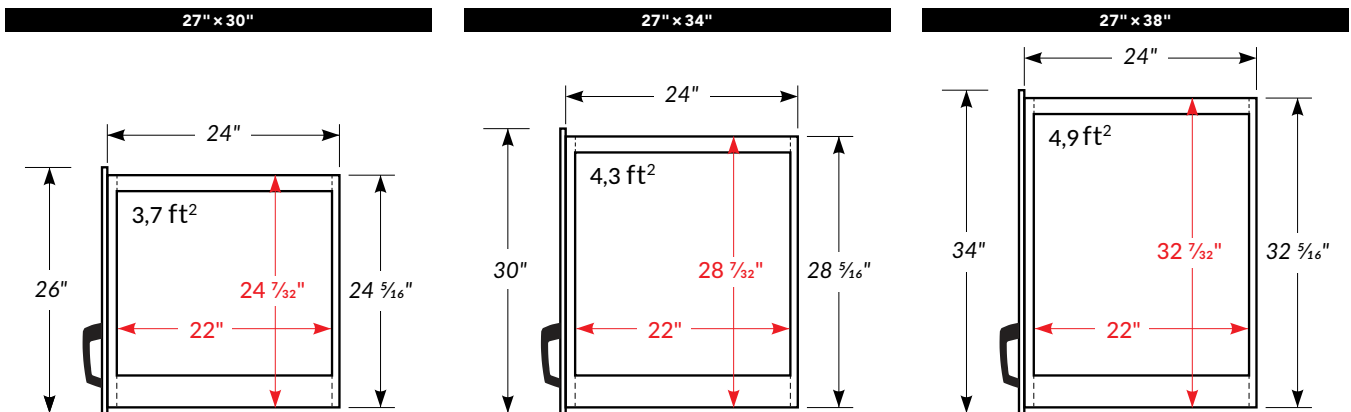



## DRAWER WIDTHS

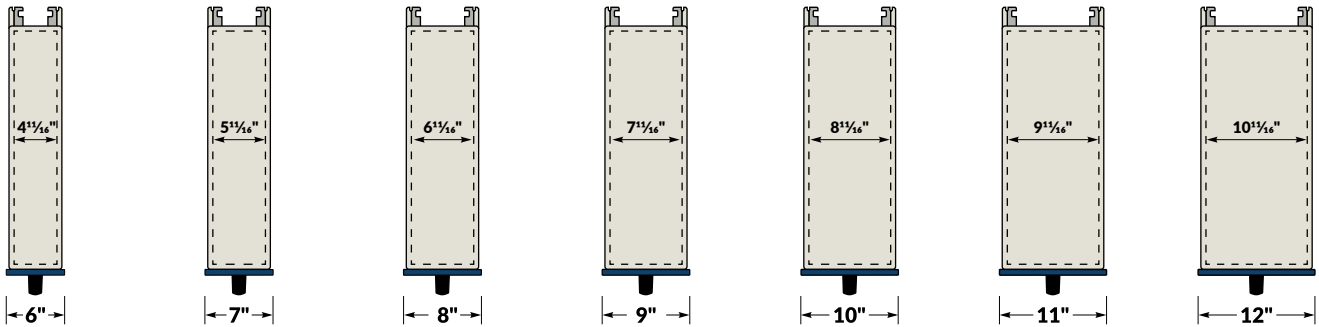

SOME OF OUR MOST POPULAR R2V CABINET MODELS ARE SHOWN BELOW:

- To subdivide your drawers [see page 82](#) for accessory layouts, or [see page 83](#) for available accessories.
- All preconfigured cabinet models include a standard lock on the cabinet and an integrated lock-in mechanism on the drawers.

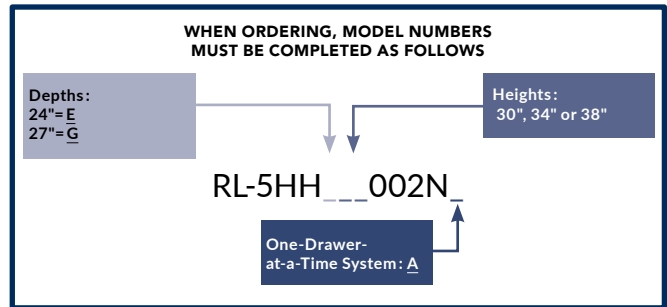

The R2V Vertical Storage System must be installed on top of an R cabinet of the same width. It cannot be installed directly on the ground. Anchoring the R2V cabinet ensures the unit is stable. For more information, refer to assembly guide R4E. There is no mobile version of this product available.

## 24" WIDE



3 DRAWERS  
RL-5HC\_\_002N\_



3 DRAWERS  
RL-5HC\_\_004N\_



2 DRAWERS  
RL-5HC\_\_006N\_

# PRECONFIGURED MODELS

## 30" WIDE



3 DRAWERS  
RL-5HD\_\_\_002N\_



4 DRAWERS  
RL-5HD\_\_\_004N\_



3 DRAWERS  
RL-5HD\_\_\_006N\_

## 36" WIDE



4 DRAWERS  
RL-5HE\_\_\_002N\_



4 DRAWERS  
RL-5HE\_\_\_004N\_



3 DRAWERS  
RL-5HE\_\_\_006N\_

## 48" WIDE



6 DRAWERS  
RL-5HH\_\_\_002N\_



6 DRAWERS  
RL-5HH\_\_\_004N\_



4 DRAWERS  
RL-5HH\_\_\_006N\_

## 54" WIDE



5 DRAWERS  
RL-5HJ\_\_002N\_



6 DRAWERS  
RL-5HJ\_\_004N\_



5 DRAWERS  
RL-5HJ\_\_006N\_



5 DRAWERS  
RL-5HJ\_\_008N\_

## 60" WIDE



8 DRAWERS  
RL-5HK\_\_002N\_



6 DRAWERS  
RL-5HK\_\_004N\_



5 DRAWERS  
RL-5HK\_\_006N\_



6 DRAWERS  
RL-5HK\_\_008N\_

# PRECONFIGURED MODELS

## VERTICAL DRAWER INTERIORS

Choose the interior layout of each drawer using the preconfigured suggestions on this page. Complete your layouts with accessories, [see page 83](#), or in the 5S and Wall Mounted Storage section, [see pages 214-215](#), as needed.

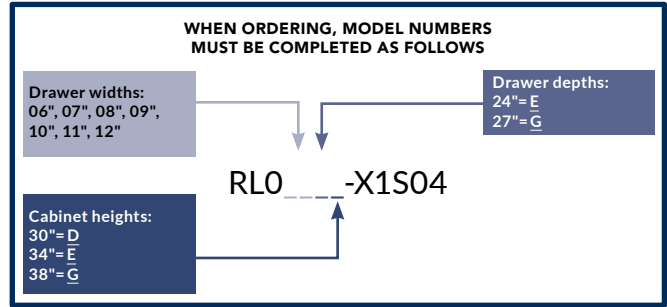

TRAY WITH 8 MAGNETIC DIVIDERS  
RLO\_\_\_-T1001



ADJUSTABLE UTILITY PANEL<sup>1</sup> AND 20 HOOKS  
RLO\_\_\_-U0C02



SIDE UTILITY PANEL, 20 HOOKS AND PLASTIC BINS<sup>2</sup>  
RLO\_\_\_-U0S03



2 TRAYS AND 12 MAGNETIC DIVIDERS  
RLO\_\_\_-T2001



ADJUSTABLE UTILITY PANEL<sup>1</sup>,  
2 TRAYS AND 16 MAGNETIC DIVIDERS<sup>3</sup>  
RLO\_\_\_-X2C01



SIDE UTILITY PANEL, 1 TRAY,  
4 MAGNETIC DIVIDERS AND PLASTIC BINS<sup>2</sup>  
RLO\_\_\_-X1S04

NOTES: 1: Hook perforations on both sides of the panel. Panel position is adjustable across the shelf width.  
2: Not available for 7"W drawers.  
3: Available for 10"W drawers and over.  
4: Panel position is adjustable across the shelf width.

## SIDE UTILITY PANEL

RL40



- For locating tools quickly and easily
- Full-height and full-depth panel
- Installs on the far right of the drawer but can be easily repositioned on the left
- Color: Light Gray 071
- Depths available: 24" (18 holes) and 27" (21 holes)
- To order: Specify the depth required

PRODUCT NO.	CABINET HEIGHT
RL40-__30	30"
RL40-__34	34"
RL40-__38	38"

## ADJUSTABLE UTILITY PANEL

RL43



- For locating tools quickly and easily
- Full-height and full-depth panel
- Tools can be hung on each side of the panel without obstructing the drawer
- Width adjustable in ½" increments c/c
- Color: Light Gray 071
- Depths available: 24" (18 holes) and 27" (21 holes)
- To order: Specify the depth required

PRODUCT NO.	CABINET HEIGHT
RL43-__30	30"
RL43-__34	34"
RL43-__38	38"

## ADJUSTABLE TRAY

RL21



- Ideal for storing assorted products and tools (cans, bottles, etc.)
- Tool-free installation and adjustment
- Includes edges to prevent objects from falling to the bottom of the drawer
- Height adjustable in 1" increments c/c
- Compatible with side utility panels. For compatibility with adjustable utility panels, refer to technical guide R68
- Color: Light Gray 071
- Widths available: 05", 06", 07", 08", 09", 10", 11" and 12"
- To order: Specify the width required

PRODUCT NO.	DEPTH
RL21-__24	24"
RL21-__27	27"

## MAGNETIC DIVIDER

RL60 / RL61



Front to back

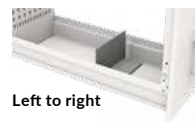

Left to right

- Installs on drawer bottoms and adjustable trays
- Includes a magnetic strip for easy repositioning
- Divider height: 4"
- Color: Light Gray 071

PRODUCT NO.	
RL60-2404	24" front to back
RL60-2704	27" front to back
RL61-__04	Left to right

NOTES: Complete the RL61 number with the drawer or the tray width: 05", 06", 07", 08", 09", 10", 11" and 12".

Not compatible with non-slip drawer/tray liners.

## NON-SLIP DRAWER/TRAY LINER

RL49



- Protects tools stored in the drawer or on a tray
- Thickness: ¼"
- Widths available: 05", 06", 07", 08", 09", 10", 11" and 12"
- To order: Specify the width required

PRODUCT NO.	DEPTH
RL49-__24	24"
RL49-__27	27"

NOTE: Not compatible with magnetic dividers.

## LABEL HOLDER

RL81 / RL82



- For 7/8"H paper labels
- Label holder height: 15/16"
- Widths available: 06" and 09"
- To order: Specify the width required

PRODUCT NO.	
RL81-__	Self-adhesive
RL82-__	Magnetic



Refer to technical guide R68 for details on accessories compatibility.

## VERTICAL DRAWER



- Painted steel drawer
- Interior color: Light Gray 071
- Front and back inner panels with perforations for hanging tools
- 200lb. load capacity, 100% extension
- Heavy-duty construction
- Drawer widths available: 06", 07", 08", 09", 10", 11" and 12"
- Wide range of accessories available to customize the drawer to your storage needs, [see page 83](#)
- For preconfigured models of vertical drawers with accessories, [see page 82](#)
- Available with an integrated lock-in mechanism

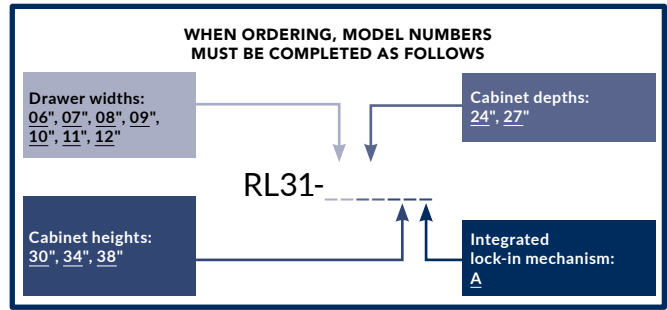

## R2V VERTICAL HOUSING

RL30



- Designed to accommodate RL31 vertical drawers
- Heights available: 30", 34" and 38"
- To order: Specify the height required, e.g., RL30-482430
- For a safety hasp lock, replace L3 with LP
- For an electronic lock, replace L3 with L50
- For a One-Drawer-at-a-Time system, add A to the end of the product number

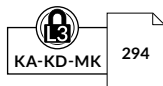

PRODUCT NO.	W × D	INTERIOR W
RL30-1824__-L3_	18" × 24"	16"
RL30-1827__-L3_	18" × 27"	16"
RL30-2424__-L3_	24" × 24"	22"
RL30-2427__-L3_	24" × 27"	22"
RL30-3024__-L3_	30" × 24"	28"
RL30-3027__-L3_	30" × 27"	28"
RL30-3624__-L3_	36" × 24"	34"
RL30-3627__-L3_	36" × 27"	34"
RL30-4824__-L3_	48" × 24"	46"
RL30-4827__-L3_	48" × 27"	46"
RL30-5424__-L3_	54" × 24"	52"
RL30-5427__-L3_	54" × 27"	52"
RL30-6024__-L3_	60" × 24"	58"
RL30-6027__-L3_	60" × 27"	58"

NOTE: For a cabinet housing for two users, [see page 292](#).



The R2V Vertical Storage System must be installed on top of an R cabinet of the same width. It cannot be installed directly on the ground.

Anchoring the R2V cabinet ensures the unit is stable. For more information, refer to assembly guide R4E.

There is no mobile version of this product available.

## CENTRAL LOCKING SYSTEM

L3



- Locks all vertical drawers in the cabinet at the same time
- Drawer positions can be changed
- Easy retrofit
- To order: Add L3 to the cabinet product number, e.g., RL30-302738L3
- For replacement parts or to retrofit this mechanism, order an RL00-WWDDL3



PRODUCT NO.  
L3

## SAFETY HASP SYSTEM

LP



- Locks all vertical drawers in the cabinet at the same time
- Drawer positions can be changed
- To order: Add LP to the cabinet product number, e.g., RL30-302738LP
- For replacement parts or to retrofit this mechanism, order an RL00-WWDDL<sup>LP</sup>

PRODUCT NO.  
LP

## ELECTRONIC LOCK

L50



- Locks all vertical drawers in the cabinet at the same time
- Drawer positions can be changed
- Fast and easy to use
- No key required
- Up to 20 different users
- 4- to 8-digit access codes
- To order: Add L50 to the cabinet product number, e.g., RL30-302738L50
- For replacement parts or to retrofit this mechanism, order an RL00-WWDDL<sup>L50</sup>



PRODUCT NO.  
L50

## ONE-DRAWER-AT-A-TIME SYSTEM



A

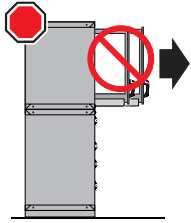

- Prevents more than one drawer from opening at the same time for greater stability
- To order: Add A to the model number, see [pages 79-81](#)

## LOCK-OUT MECHANISM

RL85



- Installs on R2V vertical drawers
- Locks vertical drawers in the open position
- Activates manually only when required

PRODUCT NO.

RL85

NOTES: Not compatible with an RL40 Side Utility Panel installed on the same side  
Not compatible with an RL91 Security Panel installed on the same side

## SECURITY PANEL

RL91



- Divides an RL29 cabinet between two users, see [page 292](#)
- Must be ordered to block access between vertical drawers
- Color: black
- To order: Specify the housing height required – 30", 34" or 38", e.g., RL91-2430

PRODUCT NO.      DEPTH

RL91-24\_\_      24"

RL91-27\_\_      27"

## INTEGRATED LOCK-IN MECHANISM



A



- Stops the vertical drawer from opening on its own
- Activates by pressing the handle button
- The vertical drawer can be opened with one hand only
- Closes with a simple push
- To order: Add A to the drawer product number, e.g., RL31-062430A
- For replacement parts or to retrofit this mechanism, order an RY48-A

PRODUCT NO.

A

## HORIZONTAL SECURITY BAR

RL10



- Locks all vertical drawers in a cabinet with a key or padlock
- Spans the width of the cabinet
- Allows full access to drawers
- To order: Add L3 or LP to the product number, e.g., RL10-48L3

PRODUCT NO.

WIDTH

RL10-18\_\_      18"

RL10-24\_\_      24"

RL10-30\_\_      30"

RL10-36\_\_      36"

RL10-48\_\_      48"

RL10-54\_\_      54"

RL10-60\_\_      60"

NOTE: Compatible with an R cabinet underneath with an RB10 Vertical Security Bar installed





INDEX	PAGE(S)
Spider® Shelving System	86-87
Preconfigured Models . . . . .	88-92
Accessories . . . . .	93-100
Components . . . . .	101-105

## THE MOST VERSATILE SHELVING SYSTEM ON THE MARKET

Quick to assemble and built for heavy-duty industrial use, the Spider® Shelving System meets all of your storage needs. With its vast range of accessories, it is the most versatile and flexible shelving system on the market.

- By combining shelving and Mini-Racking, you can extend the range of possibilities available
- By adding modular drawers, you can organize your small parts more efficiently
- Vertical expansion is also possible with our multi-level shelving system

Designed for intensive use, our modular storage system uses the space you have available to its full potential, in areas such as warehouses, parts departments, repair shops and distribution centers.

Trust in our expertise and enjoy peace of mind, knowing all your current and future storage needs will be met.



R5SEE-871809



**LIFETIME WARRANTY**  
The Rousseau drawer rolling mechanism is covered by a lifetime warranty.





## THE ROUSSEAU DIFFERENCE



R drawers can be installed in Rousseau's Spider® Shelving System but also in over 35 commercially available shelving brands.



Easy assembly: The shelves are installed on the posts with four 14-gauge steel compression clips for quick and easy reconfiguration.



Mini-Racking can be added to maximize storage options.

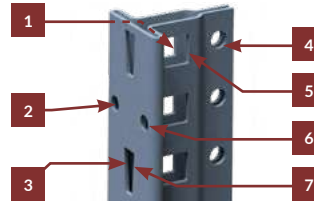

The multipurpose common post is a key structural component. Its unique tubular T shape provides up to seven fixing zones for different applications. It also has a hollow center to prevent interference between sections.



Each component has been designed to be easy to use.

NOTE: The unique design of the Spider® post is a trademark of Rousseau Metal Inc.

## GENERAL DIMENSIONS

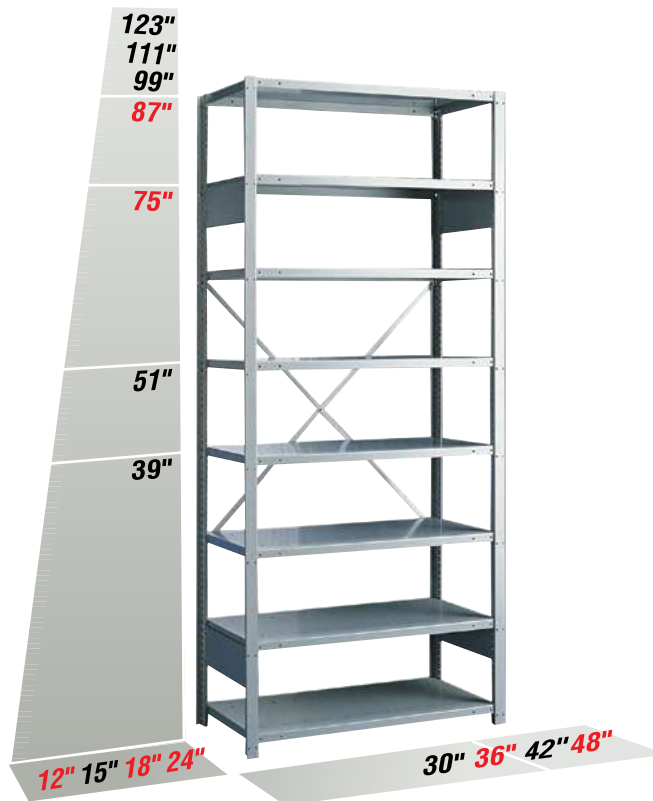

SHE1024

NOTE: Popular dimensions are shown in red.

# PRECONFIGURED MODELS



SRE1023



SRE2023

**WHEN ORDERING, MODEL NUMBERS MUST BE COMPLETED AS FOLLOWS**

H for posts with a smooth surface  
R for posts with a perforated surface

SH SR BOLTED uprights  
WELED uprights

Starter Unit: D, E  
Add-on Unit: A, B

S

001

1 for open shelving  
2 for closed shelving

e.g., SHD1001

For an open shelving starter unit with smooth surface posts and bolted uprights.

## 36"W, 42"W AND 48"W SINGLE SHELVING UNITS, OPEN AND CLOSED

### OPEN SHELVING



SRE1011  
Starter unit



SRB1011  
Add-on unit

HERE ARE SOME OF OUR MOST POPULAR PRECONFIGURED MODELS OF OPEN AND CLOSED SHELVING UNITS

- The preconfigured models in this section include open or closed uprights and BOX shelves
- The closed shelving preconfigured models in this section include back panels and a front base
- The open shelving preconfigured models in this section include a back brace

DIMENSIONS			NUMBER OF SHELVES				
W	D	H	5	6	7	8	9
36"	12"	75"	S__001	S__007	S__013	S__019	S__225
	18"		S__002	S__008	S__014	S__020	S__226
	24"		S__003	S__009	S__015	S__021	S__227
	12"	87"	S__004	S__010	S__016	S__022	S__228
	18"		S__005	S__011	S__017	S__023	S__229
	24"		S__006	S__012	S__018	S__024	S__230
	12"	99"	S__401	S__407	S__413	S__419	S__625
	18"		S__402	S__408	S__414	S__420	S__626
	24"		S__403	S__409	S__415	S__421	S__627
42"	12"	75"	S__131	S__137	S__143	S__149	S__255
	18"		S__132	S__138	S__144	S__150	S__256
	24"		S__133	S__139	S__145	S__151	S__257
	12"	87"	S__134	S__140	S__146	S__152	S__258
	18"		S__135	S__141	S__147	S__153	S__259
	24"		S__136	S__142	S__148	S__154	S__260
	12"	99"	S__531	S__537	S__543	S__549	S__555
	18"		S__532	S__538	S__544	S__550	S__556
	24"		S__533	S__539	S__545	S__551	S__557
48"	12"	75"	S__031	S__037	S__043	S__049	S__355
	18"		S__032	S__038	S__044	S__050	S__356
	24"		S__033	S__039	S__045	S__051	S__357
	12"	87"	S__034	S__040	S__046	S__052	S__358
	18"		S__035	S__041	S__047	S__053	S__359
	24"		S__036	S__042	S__048	S__054	S__360
	12"	99"	S__431	S__437	S__443	S__449	S__455
	18"		S__432	S__438	S__444	S__450	S__456
	24"		S__433	S__439	S__445	S__451	S__457

NOTES: For more information about drawers in shelving, [see page 130](#).  
Shelving with drawers must be anchored to the ground with a floor anchoring kit (SH45/SH47).

### CLOSED SHELVING



SRE2011  
Starter unit



SRB2011  
Add-on unit

## 36"W, 42"W AND 48"W BACK-TO-BACK SHELVING, OPEN AND CLOSED

### OPEN SHELVING



SRE1011B  
Starter unit



SRB1011B  
Add-on unit

HERE ARE SOME OF OUR MOST POPULAR PRECONFIGURED MODELS OF BACK-TO-BACK, OPEN AND CLOSED SHELVING UNITS

- The preconfigured models in this section include open or closed uprights and BOX shelves
- The closed shelving preconfigured models in this section include back panels and front bases
- The open shelving preconfigured models in this section include a back brace

### CLOSED SHELVING



SRE2011B  
Starter unit



SRB2011B  
Add-on unit

DIMENSIONS			NUMBER OF SHELVES			
W	D*	H	10	12	14	16
36"	24"	75"	S__001B	S__007B	S__013B	S__019B
	36"		S__002B	S__008B	S__014B	S__020B
	48"		S__003B	S__009B	S__015B	S__021B
	24"		S__004B	S__010B	S__016B	S__022B
	36"		S__005B	S__011B	S__017B	S__023B
	48"		S__006B	S__012B	S__018B	S__024B
	24"	S__401B	S__407B	S__413B	S__419B	
	36"	S__402B	S__408B	S__414B	S__420B	
	48"	S__403B	S__409B	S__415B	S__421B	
	24"	S__131B	S__137B	S__143B	S__149B	
	36"	S__132B	S__138B	S__144B	S__150B	
	48"	S__133B	S__139B	S__145B	S__151B	
42"	24"	87"	S__134B	S__140B	S__146B	S__152B
	36"		S__135B	S__141B	S__147B	S__153B
	48"		S__136B	S__142B	S__148B	S__154B
	24"		S__531B	S__537B	S__543B	S__549B
	36"		S__532B	S__538B	S__544B	S__550B
	48"		S__533B	S__539B	S__545B	S__551B
	24"	S__031B	S__037B	S__043B	S__049B	
	36"	S__032B	S__038B	S__044B	S__050B	
	48"	S__033B	S__039B	S__045B	S__051B	
	24"	S__034B	S__040B	S__046B	S__052B	
	36"	S__035B	S__041B	S__047B	S__053B	
	48"	S__036B	S__042B	S__048B	S__054B	
48"	24"	99"	S__431B	S__437B	S__443B	S__449B
	36"		S__432B	S__438B	S__444B	S__450B
	48"		S__433B	S__439B	S__445B	S__451B

NOTES: \* The depth includes two units. e.g., 24" = two 12" units

For more information about drawers in shelving, see page 130.

Shelving with drawers must be anchored to the ground with a floor anchoring kit (SH45/SH47).

## 87"H CLOSED SHELVING WITH ACCESSORIES

Some of our most popular shelving units are shown below

NOTES: The 2" front base is always included with closed shelving preconfigured models.

For help on completing the product number, see page 88.



SRE3009

#### SHELVING WITH DIVIDERS

- 8 shelves
- 28 slots:
  - 28 slots 12"W×9"H
- 21 dividers, 5½"H



SRE3022

#### SHELVING WITH DIVIDERS

- 8 shelves
- 19 slots:
  - 18 slots 12"W×12"H
  - 1 slot 36"W×12"H
- 12 dividers, 12"H
- 6 shelf fronts



SRE3062

#### SHELVING WITH DIVIDERS FOR X-RAY STORAGE

- 6 shelves
- 60 slots:
  - 48 slots 3"W×16"H
  - 12 slot 3"W×20"H
- 44 dividers, 16"H
- 11 dividers, 20"H

PRODUCT NO.	W×D
S_3008	36"×12"
S_3009	36"×18"
S_3010	36"×24"

PRODUCT NO.	W×D
S_3021	36"×12"
S_3022	36"×18"
S_3023	36"×24"

PRODUCT NO.	W×D
S_3062	36"×18"

# PRECONFIGURED MODELS



## SHELVING WITH SLIDING PANELS

### OPEN SHELVING



SRE1C-EE870103  
Starter unit



SRB1C-EE870103  
Add-on unit

HERE ARE SOME OF OUR MOST POPULAR PRECONFIGURED MODELS OF SLIDING PANELS.

- The preconfigured models in this section include open or closed uprights, sliding panels (with handles), panel support and a BOX shelf
- The closed shelving preconfigured models in this section include back panels and the open shelving preconfigured models in this section include a back brace
- For storing a wide range of items: tools, straps, cables, pipes, gaskets, etc.
- Load capacity: 300lb. per panel (weight evenly distributed)
- Refer to technical guide S84 for spacing between panels
- For 5S accessories, [see pages 214-215](#)

### CLOSED SHELVING



SRE2C-EE870103  
Starter unit



SRB2C-EE870103  
Add-on unit

DIMENSIONS					
W	D	H	PRODUCT NO.	NO. OF PANELS	NO. OF HOLES
30"	18"	75"	S__C-DC750102	2	15
	24"		S__C-DE750102	2	21
	18"	87"	S__C-DC870102	2	15
	24"		S__C-DE870102	2	21
36"	18"	75"	S__C-EC750103	3	15
	24"		S__C-EE750103	3	21
	18"	87"	S__C-EC870103	3	15
	24"		S__C-EE870103	3	21
42"	18"	75"	S__C-GC750104	4	15
	24"		S__C-GE750104	4	21
	18"	87"	S__C-GC870104	4	15
	24"		S__C-GE870104	4	21
48"	18"	75"	S__C-HC750105	5	15
	24"		S__C-HE750105	5	21
	18"	87"	S__C-HC870105	5	15
	24"		S__C-HE870105	5	21



SHE1C-EE870103\*

**WHEN ORDERING, MODEL NUMBERS MUST BE COMPLETED AS FOLLOWS**

H for posts with a smooth surface  
R for posts with a perforated surface

Height: 75", 87"

SH SR BOLTED uprights  
WELDED uprights

Starter Unit D E  
Add-on Unit A B

S

C-EE\_\_0104

1 for open shelving  
2 for closed shelving

e.g., SHD1C-EE750104

For an open shelving starter unit with smooth surface posts and bolted uprights.



The panel support must be anchored to the ground to ensure stability (anchoring kit included).

NOTE: \*5S accessories not included.

## SHELVING WITH MODULAR DRAWERS

Some of our most popular shelving units with drawers are shown below.

- The preconfigured models in this section include welded closed uprights and hook-on mounting brackets for Spider® shelving for quick and easy assembly
- Additional accessories available: utility panels, plastic bin panels, finishing panels, shelf dividers, doors, etc., see pages 94-100
- To order an add-on unit, add **A** to the product number



R5SEE-871817

### IMPORTANT

Drawer compartments are included in all models.

See number of compartments and proposed layouts in the chart below.

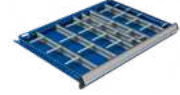

To order drawers without compartments, replace the last two digits of the model number with the next even number up.

e.g., R5SEC-751801 with  
R5SEC-751802 without

#### NUMBER OF COMPARTMENTS (LAYOUT CODE)

DRAWER DIMENSIONS	3"H TO 5"H	6"H TO 8"H	9"H AND HIGHER
36"W × 18"D	24 (0518)	8 (0304)	6 (0203)
36"W × 24"D	30 (0524)	12 (0308)	9 (0206)
42"W × 18"D	18 (0512)	12 (0308)	6 (0203)
42"W × 24"D	30 (0524)	12 (0308)	8 (0304)
48"W × 18"D	32 (0724)	10 (0405)	8 (0304)
48"W × 24"D	40 (0732)	15 (0410)	8 (0304)

NOTE: For interior drawer dimensions, see pages 226-228



Shelving units with drawers must be anchored to the ground (anchoring kit included).

## SHELVING WITH 18"H, 24"H, 36"H AND 48"H BANKS OF MODULAR DRAWERS

### SHELVING WITH 18"H BANK OF MODULAR DRAWERS



R5SEE-871801

- 4 drawers:
  - 3 drawers, 4"H
  - 1 drawer, 6"H
- 75"H (5 shelves) or 87"H (6 shelves) shelving

W × D	75"H	87"H
36" × 18"	R5SEC-751801_	R5SEC-871801_
36" × 24"	R5SEE-751801_	R5SEE-871801_
42" × 18"	R5SGC-751801_	R5SGC-871801_
42" × 24"	R5SGE-751801_	R5SGE-871801_
48" × 18"	R5SHC-751801_	R5SHC-871801_
48" × 24"	R5SHE-751801_	R5SHE-871801_

### SHELVING WITH 24" OF MODULAR DRAWERS



R5SEE-872401

- 5 drawers:
  - 3 drawers, 4"H
  - 2 drawers, 6"H
- 75"H (5 shelves) or 87"H (6 shelves) shelving

W × D	75"H	87"H
36" × 18"	R5SEC-752401_	R5SEC-872401_
36" × 24"	R5SEE-752401_	R5SEE-872401_
42" × 18"	R5SGC-752401_	R5SGC-872401_
42" × 24"	R5SGE-752401_	R5SGE-872401_
48" × 18"	R5SHC-752401_	R5SHC-872401_
48" × 24"	R5SHE-752401_	R5SHE-872401_

### SHELVING WITH 36"H BANK OF MODULAR DRAWERS



R5SEE-873601

- 7 drawers:
  - 3 drawers, 4"H
  - 4 drawers, 6"H
- 75"H (5 shelves) or 87"H (6 shelves) shelving

W × D	75"H	87"H
36" × 18"	R5SEC-753601_	R5SEC-873601_
36" × 24"	R5SEE-753601_	R5SEE-873601_
42" × 18"	R5SGC-753601_	R5SGC-873601_
42" × 24"	R5SGE-753601_	R5SGE-873601_
48" × 18"	R5SHC-753601_	R5SHC-873601_
48" × 24"	R5SHE-753601_	R5SHE-873601_



R5SEE-873603

- 7 drawers:
  - 4 drawers, 4"H
  - 2 drawers, 6"H
  - 1 drawer, 8"H
- 75"H (5 shelves) or 87"H (6 shelves) shelving

W × D	75"H	87"H
36" × 18"	R5SEC-753603_	R5SEC-873603_
36" × 24"	R5SEE-753603_	R5SEE-873603_
42" × 18"	R5SGC-753603_	R5SGC-873603_
42" × 24"	R5SGE-753603_	R5SGE-873603_
48" × 18"	R5SHC-753603_	R5SHC-873603_
48" × 24"	R5SHE-753603_	R5SHE-873603_

# PRECONFIGURED MODELS

## SHELVING WITH 48" H BANK OF MODULAR DRAWERS



R5SEE-874801

- 8 drawers:
  - 8 drawers, 6"H
- 75"H (4 shelves) or 87"H (5 shelves) shelving

W×D	75"H	87"H
36"×18"	R5SEC-754801_	R5SEC-874801_
36"×24"	R5SEE-754801_	R5SEE-874801_
42"×18"	R5SGC-754801_	R5SGC-874801_
42"×24"	R5SGE-754801_	R5SGE-874801_
48"×18"	R5SHC-754801_	R5SHC-874801_
48"×24"	R5SHE-754801_	R5SHE-874801_



R5SEE-874803

- 9 drawers:
  - 4 drawers, 4"H
  - 4 drawers, 6"H
  - 1 drawer, 8"H
- 75"H (4 shelves) or 87"H (5 shelves) shelving

W×D	75"H	87"H
36"×18"	R5SEC-754803_	R5SEC-874803_
36"×24"	R5SEE-754803_	R5SEE-874803_
42"×18"	R5SGC-754803_	R5SGC-874803_
42"×24"	R5SGE-754803_	R5SGE-874803_
48"×18"	R5SHC-754803_	R5SHC-874803_
48"×24"	R5SHE-754803_	R5SHE-874803_



R5SEE-874805

- 10 drawers:
  - 6 drawers, 4"H
  - 4 drawers, 6"H
- 75"H (4 shelves) or 87"H (5 shelves) shelving

W×D	75"H	87"H
36"×18"	R5SEC-754805_	R5SEC-874805_
36"×24"	R5SEE-754805_	R5SEE-874805_
42"×18"	R5SGC-754805_	R5SGC-874805_
42"×24"	R5SGE-754805_	R5SGE-874805_
48"×18"	R5SHC-754805_	R5SHC-874805_
48"×24"	R5SHE-754805_	R5SHE-874805_



R5SEE-874807

- 11 drawers:
  - 4 drawers, 3"H
  - 3 drawers, 4"H
  - 4 drawers, 6"H
- 75"H (4 shelves) or 87"H (5 shelves) shelving

W×D	75"H	87"H
36"×18"	R5SEC-754807_	R5SEC-874807_
36"×24"	R5SEE-754807_	R5SEE-874807_
42"×18"	R5SGC-754807_	R5SGC-874807_
42"×24"	R5SGE-754807_	R5SGE-874807_
48"×18"	R5SHC-754807_	R5SHC-874807_
48"×24"	R5SHE-754807_	R5SHE-874807_



R5SEE-874809

- 7 drawers:
  - 2 drawers, 3"H
  - 3 drawers, 4"H
  - 2 drawers, 6"H
- 1 front-access roll-out shelf
- 75"H (4 shelves) or 87"H (5 shelves) shelving

W×D	75"H	87"H
36"×18"	R5SEC-754809_	R5SEC-874809_
36"×24"	R5SEE-754809_	R5SEE-874809_
42"×18"	R5SGC-754809_	R5SGC-874809_
42"×24"	R5SGE-754809_	R5SGE-874809_
48"×18"	R5SHC-754809_	R5SHC-874809_
48"×24"	R5SHE-754809_	R5SHE-874809_



## DIVIDERS

### SHELF DIVIDER

SH50



- The dividers are installed by inserting into other dividers
- Two nylon clips are provided with each divider
- Sizes given are nominal dimensions (c/c shelves)
- Painted steel



PRODUCT NO.	D×H
SH50-1206	12"×6"
SH50-1209	12"×9"
SH50-1212	12"×12"
SH50-1215	12"×15"
SH50-1218	12"×18"
SH50-1506	15"×6"
SH50-1512	15"×12"
SH50-1806	18"×6"
SH50-1809	18"×9"
SH50-1812	18"×12"
SH50-1815	18"×15"
SH50-1818	18"×18"
SH50-1824	18"×24"

PRODUCT NO.	D×H
SH50-2406	24"×6"
SH50-2409	24"×9"
SH50-2412	24"×12"
SH50-2415	24"×15"
SH50-2418	24"×18"
SH50-2424	24"×24"

#### DIVIDERS FOR X-RAY STORAGE

PRODUCT NO.	D×H
SH50-1816	18"×16"
SH50-1820	18"×20"

NOTE: Other sizes are available. Contact your customer service representative for more information.



SHE3062

### PARTIAL DIVIDER

SH52



- Unique patented design for easy position changes
- Height: 5½"
- Easy tool-free installation

PRODUCT NO.	DEPTH	FOR SHELVES
SH52-1206	7¼"	12"D
SH52-1506	10⅝"	15"D
SH52-1806	13¼"	18"D
SH52-2406	19⅝"	24"D

Includes pictograms for easy installation



### DIVIDING RODS

SH56



- Sold in pairs
- ¼" dia. stainless steel rod
- Includes a 90° bend at one end to keep it in place
- Superior rigidity to the plastic rods often found on the market for this type of application
- Excellent corrosion and chemical resistance

PRODUCT NO.	HEIGHT
SH56-72	72"
SH56-84	84"
SH56-96	96"



SRP0410

## LABEL HOLDERS

### MAGNETIC LABEL HOLDER

SH82



- Magnetic plastic
- Comes in 6" lengths and can be cut to desired length with scissors or a knife

PRODUCT NO.	W×H
SH82-600	6"×1"

NOTE: For use with paper labels (not included). Label must be ¼" high.

### SELF-ADHESIVE LABEL HOLDER

SH81



- Attaches with a self-adhesive strip
- Full-width label holder for use with paper labels

PRODUCT NO.	W×H
SH81-36	36"×1"
SH81-42	42"×1"
SH81-48	48"×1"

NOTE: Paper labels (not included).

# ACCESSORIES

## PANELS

### FINISHING PANEL

SH37



- Finishing panel for end-of-aisle shelving units
- Quick and easy hook-on assembly
- Creates a neater appearance
- Compatible with certain multi-level shelving applications. Contact Customer Service for more information
- To order: Complete the product number with the depth required: 12", 15", 18" or 24"

PRODUCT NO.	HEIGHT
SH37-__075	75"
SH37-__087	87"

### SIDE UTILITY PANEL

SH68



- The SH68 Side Utility Panel can be installed on either the inside or outside of the upright
- Simple tool-free assembly
- Four widths available: 12" (8 holes), 15" (12 holes), 18" (14 holes) and 24" (20 holes)
- Compatible with WM9F, WM9G, WM9H, WM9J and WM9L light-duty hooks, and WM9A and WM9B heavy-duty hooks
- Compatible with WM9C rails, and WM9D, WM9M, WM9N, WM9P and WM9Q holders
- Compatible with WM21 shelves
- Load capacity: 50lb./sq. ft., 300lb. max. per panel
- To order: Complete the product number with the depth required: 12", 15", 18" or 24"

PRODUCT NO.	HEIGHT
SH68-__14	14"
SH68-__20	20"
SH68-__32	32"

### FULL-HEIGHT HEAVY-DUTY UTILITY PANEL

SH69

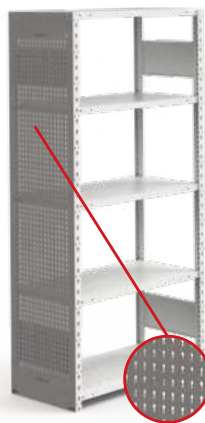

- Full-height heavy-duty utility panel for end-of-aisle shelving units
- Holes spaced 1" apart c/c
- Quick and easy hook-on assembly
- Creates a neater appearance
- Four widths available: 12" (9 holes), 15" (13 holes), 18" (15 holes) and 24" (21 holes)
- Compatible with WM9F, WM9G, WM9H, WM9J and WM9L light-duty hooks, and WM9A and WM9B heavy-duty hooks
- Also compatible with WM9C rails; WM9D, WM9M, WM9N, WM9P and WM9Q holders
- Compatible with WM21 shelves
- Load capacity: 50lb./sq. ft., 500lb. max. per panel
- Compatible with certain multi-level shelving applications. Contact Customer Service for more information
- To order: Complete the product number with the depth required: 12", 15", 18" or 24"

PRODUCT NO.	HEIGHT
SH69-__51	51"
SH69-__75	75"
SH69-__87	87"

### BACK UTILITY PANEL

SR79

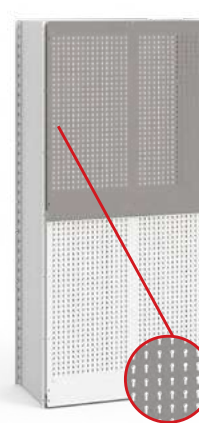

- Utility panel for the backs of shelving
- Load capacity: 250lb. per panel
- Easy to install
- Installs at the back of an existing shelving unit
- Holes spaced 1" apart c/c
- Compatible with SH31 back panels
- Four widths available: 30" (26 holes), 36" (32 holes), 42" (38 holes) and 48" (44 holes)
- Compatible with WM9F, WM9G, WM9H, WM9J and WM9L light-duty hooks, and WM9A and WM9B heavy-duty hooks
- Compatible with WM9C rails, and WM9D, WM9M, WM9N, WM9P and WM9Q holders
- Compatible with SR uprights that have perforated sides
- Panel combinations:
  - 75"H posts (39"H + 39"H)
  - 87"H posts (39"H + 51"H)
  - 99"H posts (51"H + 51"H)
- To order: Complete the product number with the width required: 30", 36", 42" or 48"

PRODUCT NO.	HEIGHT
SR79-__39	39"
SR79-__51	51"

NOTE: SR79 panels are not reversible



## BACK (INTERIOR) OR SIDE PLASTIC BIN PANEL

SH65 / SH66



- SH65 Back Plastic Bin Panel: installs inside a shelving unit between two shelves
- SH66 Side Plastic Bin Panel: can be installed on either the inside or outside of the upright
- Simple tool-free assembly
- Used for hanging RG20 bins
- Compatible with all brands of plastic bins with hanging lip on the market

BACK	W×H	SIDE	D×H
SH65-3020	30" × 20"	SH66-1220	12" × 20"
SH65-3032	30" × 32"	SH66-1232	12" × 32"
SH65-3620	36" × 20"	SH66-1520	15" × 20"
SH65-3632	36" × 32"	SH66-1532	15" × 32"
SH65-4220	42" × 20"	SH66-1820	18" × 20"
SH65-4232	42" × 32"	SH66-1832	18" × 32"
SH65-4820	48" × 20"	SH66-2420	24" × 20"
SH65-4832	48" × 32"	SH66-2432	24" × 32"

NOTE: For SH65 installation, allow a minimum 4" c/c between shelves.

## BACK UTILITY PANEL (INTERIOR)

SH67



- The SH67 Back Utility Panel installs inside a shelving unit between two shelves
- Simple tool-free assembly
- Four widths available: 30" (26 holes), 36" (32 holes), 42" (38 holes) and 48" (44 holes)
- Compatible with WM9F, WM9G, WM9H, WM9J and WM9L light-duty hooks, and WM9A and WM9B heavy-duty hooks
- Compatible with WM9C rails, and WM9D, WM9M, WM9N, WM9P and WM9Q holders
- Compatible with WM21 shelves
- Load capacity: 50lb./sq. ft., 300lb. max. per panel
- To order: Complete the product number with the width required: 30", 36", 42" or 48"

PRODUCT NO.	HEIGHT
SH67-__14	14"
SH67-__20	20"
SH67-__32	32"

NOTE: For SH67 installation, allow a minimum 4" c/c between shelves.

## LED LIGHTS

### LED LIGHT FOR SPIDER® SHELVING

SH95



- Brightens shaded areas under shelves
- Can be installed under SH20 shelves
- Brighter and more energy efficient than a fluorescent tube
- Color temperature: 6000-7000K (cool)
- Rigid aluminum housing
- Includes a 10-foot power cord

PRODUCT NO.	FOR
SH95-01	30"W or 36"W shelves
SH95-02	42"W or 48"W shelves



## DOORS, HANDLES AND LOCKS

### ROTATING HANDLE

Door opens by turning handle to the left or the right.



### LOCK POSITION

The hasp or lock are positioned so they do not impede the hand.



### DOUBLE LOCK

Add a second lock to your door.



### ELECTRONIC LOCK

Easier management of door access permissions.



- Two locks can be used for maximum security
- To order: Specify the type of lock required, e.g., SH43-3075L3 + CZ06-LP to add an LP lock as well as the lock ordered

PRODUCT NO.	DESCRIPTION
CZ05-L3	To add an L3 lock
CZ06-LP	To add an LP lock

NOTE: To add a second lock to an existing door, please contact Customer Service.

# ACCESSORIES

## SOLID DOORS WITH FRAME

SH41



SRE3205

- The doors open 180° and have a recessed lock and handle
- Three types of lock available: L3 for a standard central lock, LP for a safety hasp or L50 for an electronic lock
- Quick and easy installation
- Integrated spacer frame for installation of Rousseau modular drawers
- Frame is 2" deep
- Compatible with Rousseau Spider® shelving only
- Widths available: 30", 36", 42" and 48"
- Heights available: 39", 41", 51", 53", 63", 75", 87" and 99"
- To order: Specify the width and height of the door, e.g., SH41-3075L3

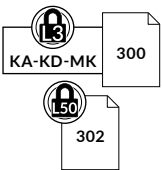

PRODUCT NO.	LOCK TYPE
SH41-___L3	Standard Lock
SH41-___LP	Safety Hasp
SH41-___L50	Electronic Lock

## POLYCARBONATE DOORS WITH FRAME

SH43



SRE3204

- Polycarbonate front panels provide visibility of the shelving contents
- Excellent impact resistance
- The doors open 180° and have a recessed lock and handle
- Three types of lock available: L3 for a standard central lock, LP for a safety hasp or L50 for an electronic lock
- Quick and easy installation
- Integrated spacer frame for installation of Rousseau modular drawers
- Frame is 2" deep
- Compatible with Rousseau Spider® shelving only
- Widths available: 30", 36", 42" and 48"
- Heights available: 39", 41", 51", 53", 63", 75", 87" and 99"
- To order: Specify the width and height of the door, e.g., SH43-3075L3

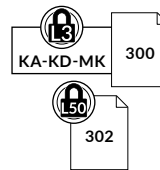

PRODUCT NO.	LOCK TYPE
SH43-___L3	Standard Lock
SH43-___LP	Safety Hasp
SH43-___L50	Electronic Lock

NOTE: When two doors are installed side-by-side, the maximum opening is just over 90° and allows full access to the contents.

## STACKED DOORS, SOLID OR POLYCARBONATE

SH91 / SH93



- Solid stacked doors: SH91
- Polycarbonate stacked doors: SH93
- The doors open 180° and have a recessed lock and handle
- Quick and easy installation
- Compatible with Rousseau Spider® shelving only
- Three types of lock available: L3 for a standard central lock, LP for a safety hasp or L50 for an electronic lock

NOTES: Choose SH41/SH43 doors if the doors are full height or start at the bottom and end at the center. Choose SH91/SH93 doors if the doors start at the top and end at the center.

Consult data sheet S64 to see all dimensions and possible configurations.

When two doors are installed side-by-side, the maximum opening is just over 90° and allows full access to the contents.

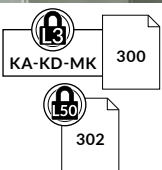

R5SEE-871811



R5SEE-871807

## FLIPPER DOOR

SH85



- Full-width handle provides a comfortable grip
- Add L3 to the product number for a standard lock, and L50 for an electronic lock
- 14"H c/c door for folder storage 16"H c/c door for binder storage
- Installs between two SH20 shelves
- Compatible with SH52 dividers
- Door heights available: 14", 16", 17" or 18"
- To order: Specify the height and type of lock required, e.g., SH85-361816L3 for a 16"H door with standard lock

PRODUCT NO.	W x D	USABLE DEPTH
SH85-3018__	30" x 18"	15"
SH85-3024__	30" x 24"	21"
SH85-3618__	36" x 18"	15"
SH85-3624__	36" x 24"	21"
SH85-4218__	42" x 18"	15"
SH85-4224__	42" x 24"	21"
SH85-4818__	48" x 18"	15"
SH85-4824__	48" x 24"	21"

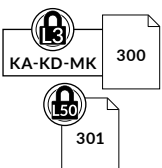

## MISCELLANEOUS RAILS AND HOLDERS

### PLASTIC BIN RAIL

SH62



- Ideal for ends of aisles. Quick and easy hook-on assembly
- Ideal for all brands of 5"H to 7"H bins
- Bins sold separately

PRODUCT NO.	DEPTH
SH62-18	18"
SH62-24	24"

### SPOOL HOLDER

SH72



- Efficient spool storage for shelving
- One or two rods available
- Load capacity: 50lb. per rod, 100lb. total per double rod
- 3/4" dia. rods compatible with most spools
- Designed so the bar can be pivoted to help with changing spools
- Different spool sizes can be combined on the same rod
- To order: Complete the product number with the number or rods required: 01 or 02

12"	18"	24"

PRODUCT NO.	W x D
SH72-3012-01	30" x 12"
SH72-3018-__	30" x 18"
SH72-3024-__	30" x 24"
SH72-3612-01	36" x 12"
SH72-3618-__	36" x 18"
SH72-3624-__	36" x 24"
SH72-4212-01	42" x 12"
SH72-4218-__	42" x 18"
SH72-4224-__	42" x 24"
SH72-4812-01	48" x 12"
SH72-4818-__	48" x 18"
SH72-4824-__	48" x 24"

### HEAVY-DUTY SQUARE HOOK

WM9A



- Used with utility panels (SH67, SH68, SH69, SH77, SH79 and SR79) to hang accessories and tools
- Flat surface on top
- Raised end to prevent accessories or tools from sliding off
- Hook-on installation
- Includes side notches for extra stability
- 50lb. load capacity
- Sold individually
- 1"W (two holes)
- Color: black

PRODUCT NO.	LENGTH
WM9A-03	3"
WM9A-06	6"
WM9A-12	12"

### CLOTHES HANGING RAIL

SH70



- Load capacity: 80lb. per rail
- Quick and easy installation
- Hooks onto the shelving posts
- Includes a 1" dia. rod and two brackets
- To order: Complete the product number with the width required: 30", 36", 42" or 48"

PRODUCT NO.	DEPTH
SH70-__18	18"
SH70-__24	24"

NOTE: Because space is required under the clothes hanging rail, this product is not recommended for multi-level shelving.

### PLASTIC BIN



RG20



- For easier storing, moving and managing of small parts
- Lightweight and durable
- 45° angled rim for easy identification of bin contents and removal of bins
- Compatible with SH65 and SH66 plastic bin panels, and SH62 and WM9C plastic bin rails
- 6" plastic bins can be subdivided

DIMENSIONS			PRODUCT NO.		
W	D	H	BIN	PARTITION	DIVIDER
3"	3"	2"	RG20-030302	-	-
4"	3"	2"	RG20-040302	-	-
6"	3"	2"	RG20-060302	RG22-0302	-
6"	6"	2"	RG20-060602	RG22-0602	RG24-0602
3"	3"	3"	RG20-030303	-	-
4"	3"	3"	RG20-040303	-	-
6"	3"	3"	RG20-060303	RG22-0303	-
6"	6"	3"	RG20-060603	RG22-0603	RG24-0603

NOTE: Height 2" = 1 1/2" real  
Height 3" = 2 1/2" real

### HEAVY-DUTY ROUND HOOK

WM9B

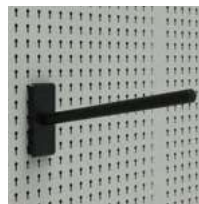

- Used with utility panels (SH67, SH68, SH69, SH77, SH79 and SR79) to hang accessories and tools
- 3/4" dia. tube
- Tools and accessories slide on and off easily
- Hook-on installation
- Includes side notches for extra stability
- 50lb. load capacity
- Sold individually
- Hook base: 2"W (three holes) x 5"H
- Color: black

PRODUCT NO.	LENGTH
WM9B-03	3"
WM9B-06	6"
WM9B-12	12"

# ACCESSORIES

## PLASTIC BIN RAIL



WM9C



- Hooks on SH67, SH68, SH69, SH77, SH79 and SR79 panels
- Plastic bins hook onto the rail for efficient storage of small parts
- Includes side notches for extra stability
- Compatible with all brands of plastic bins with hanging lip on the market
- Compatible with RG20 plastic bins
- Bins sold separately
- Widths available: 6" (7 holes), 9" (10 holes), 12" (13 holes), 15" (16 holes), 20" (21 holes), 23" (24 holes) and 26" (27 holes)
- To order: specify the width required

PRODUCT NO.	HEIGHT
WM9C-__	3"

## SCREWDRIVER HOLDER

WM9N

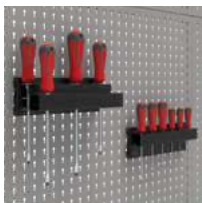

- Hooks on SH67, SH68, SH69, SH77, SH79 and SR79 panels
- Holds 6-12 screwdrivers
- Color: black

PRODUCT NO.	VERSION	W x D x H
WM9N-01	Single	9" x 1½" x 2"
WM9N-02	Double	9" x 3¾" x 2"

## LONG TOOL HOLDER

WM9Q

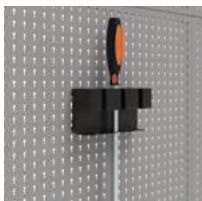

- Hooks on SH67, SH68, SH69, SH77, SH79 and SR79 panels
- Holds up to three long tools
- Color: black

PRODUCT NO.	W x D x H
WM9Q-08	8" x 3" x 4"

## VINYL RUB-ON IDENTIFICATION DECAL

WM91

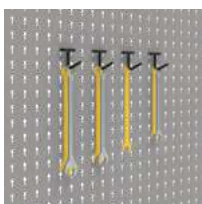

- For easy identification of where tools should be stored on utility panels (SH67, SH68, SH69, SH77, SH79 and SR79)
- Contrasting color so it is easy to notice when a tool is missing and what kind of tool it is
- Ideal for 5S method tool management
- Sold in rolls of 2'W x 8'L

PRODUCT NO.
WM91-01J

## LIGHT DUTY HOOKS

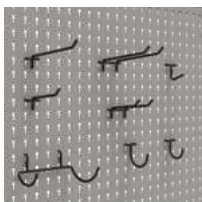

- You can store many different parts, tools and accessories using our family of light-duty hooks
- They are compatible with most panels currently available on the market (¼" dia. holes) as well as Rousseau utility panels (SH67, SH68, SH69, SH77, SH79 and SR79)
- Color: black

## CAN HOLDER



WM9D



- Hooks on SH67, SH68, SH69, SH77, SH79 and SR79 panels
- Ideal for storing various items of different sizes, such as aerosol cans
- Hook-on installation
- Includes side notches for extra stability
- Widths available: 6" (7 holes), 9" (10 holes), 12" (13 holes), 14" (15 holes), 15" (16 holes) and 20" (21 holes)
- To order: specify the width required

PRODUCT NO.	D x H
WM9D-__	3" x 4"

## PLIERS HOLDER

WM9M

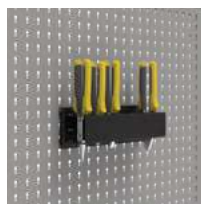

- Hooks on SH67, SH68, SH69, SH77, SH79 and SR79 panels
- Holds up to six pliers
- Color: black

PRODUCT NO.	W x D x H
WM9M-01	9" x 2½" x 2"

## TILTABLE SHELF FOR UTILITY PANEL

WM21



- Hooks on SH67, SH68, SH69, SH77, SH79 and SR79 panels
- Includes slots spaced 2" apart c/c for installing SH52 dividers
- Includes two side brackets which can be placed at right angles or at a 15° angle
- The shelf is reversible and its edge can act as a back stop for plastic bins or binders
- Load capacity: 50lb. (evenly distributed)
- Three widths available: 13" (14 holes), 15" (16 holes) and 31" (32 holes)

PRODUCT NO.	W x H
WM21-1308	13" x 8"
WM21-1312	13" x 12"
WM21-1508	15" x 8"
WM21-1512	15" x 12"
WM21-3108	31" x 8"
WM21-3112	31" x 12"

TYPE / PACKAGE	DIMENSION	PRODUCT NO.
Straight hooks/20	1 ½"D	WM9F-150
Single hooks/20	1 ½" dia.	WM9G-150
Single hooks/20	2" dia.	WM9G-200
Double back single hooks/10	3"D	WM9H-03
Double back single hooks/10	5"D	WM9H-05
Double back double hooks/10	3"D	WM9J-03
Double back double hooks/10	5"D	WM9J-05
Drill holder/1	5"W x 3½"D	WM9L-01

## MODULAR DRAWERS AND ROLL-OUT SHELVES

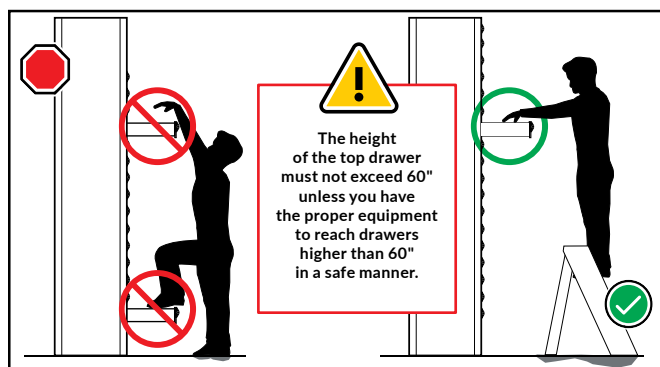

### MOUNTING BRACKETS FOR SPIDER® SHELVING RE30



- Quick and easy hook-on assembly
- Standard heights available: 18", 24", 30", 34", 36", 46" and 48"
- Mounting bracket kits are compatible with all Rousseau drawer widths (30", 36", 42" and 48")
- Each kit includes two front and two rear mounting brackets and all hardware required
- Includes holes spaced 1" apart c/c for easy adjustment of shelves
- 34"H brackets are used with 39"H posts or doors
- Two brackets can be stacked if a shelf is installed between them, [see page 137](#)
- To order non-standard mounting bracket heights, please contact Customer Service

PRODUCT NO.	HEIGHT
RE30-18	18"
RE30-24	24"
RE30-30	30"
RE30-34	34"
RE30-36	36"
RE30-46	46"
RE30-48	48"

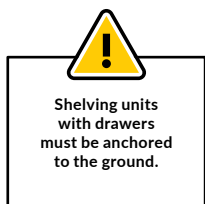

### FILLER RE90



- Installs under the bank of drawers with an adhesive strip
- Fulfills aesthetic requirements of certain work environments (hospitals, offices, etc.)
- Compatible with Rousseau Spider® and Spacesaver shelving only
- For Spacesaver shelving, order RE90-WW02 instead of RE90-WW01

PRODUCT NO.	W × H
RE90-3001	30" × 5/8"
RE90-3601	36" × 5/8"
RE90-4201	42" × 5/8"
RE90-4801	48" × 5/8"

### HEAVY-DUTY MODULAR DRAWER RF32 / RF36



- Painted steel drawer: RF32
- Drawer with stainless steel front and gray painted steel interior: RF36
- 400lb. load capacity, 100% extension
- Heavy-duty construction
- Easy to install
- Vast choice of accessories available to customize the drawer to your storage needs, [see pages 242-247](#)
- Drawer heights available: 3", 4", 5", 6", 7", 8", 9", 10", 12" and 14"
- To order: Add the drawer height to the product number and specify the type of drawer front required (painted steel or stainless steel), e.g., RF32-362406
- For preconfigured modular drawers with compartments, [see pages 224-241](#);

PRODUCT NO.	W × D
RF_-3018_	30" × 18"
RF_-3024_	30" × 24"
RF_-3618_	36" × 18"
RF_-3624_	36" × 24"
RF_-4218_	42" × 18"
RF_-4224_	42" × 24"
RF_-4818_	48" × 18"
RF_-4824_	48" × 24"

### HEAVY-DUTY FRONT ACCESS ROLL-OUT SHELF RF41



- 400lb capacity, 100% extension;
- Heavy-duty construction;
- Easy to install;
- Painted steel with 3" edges on sides and back;
- Height: 6";
- Full access to contents;
- Complete the product number by choosing the desired width: 30", 36", 42" or 48".

PRODUCT NO.	DEPTH
RF41-_18	18"
RF41-_24	24"

### HEAVY-DUTY 3-SIDED ACCESS ROLL-OUT SHELF RF45



- 400lb. load capacity, 100% extension
- Heavy-duty construction
- Easy to install
- Galvanized steel with 1½"H edge on the back
- Total height: 5"
- Full access to contents
- To order: Complete the product number with the width required: 30", 36", 42" or 48"

PRODUCT NO.	DEPTH
RF45-_18	18"
RF45-_24	24"

# ACCESSORIES

## LOCKING AND SECURITY MECHANISMS

### VERTICAL SECURITY BAR

RE80



- Locks all drawers in a shelving unit with a key or padlock
- The key or safety hasp is located at the top of the bar to facilitate access
- Covers a bank of drawers from 18"H to 48"H
- Quick and easy hook-on assembly
- More than one bar on the same mounting bracket can be installed (for different users)
- Installs on the right-hand side
- The 36"H bar is compatible with the 34"H mounting bracket, and the 48"H bar is compatible with the 46"H mounting bracket
- Compatible with Rousseau Spider® shelving only. For Spacesaver shelving, order RE81-HHL3A instead of RE80-HHL301
- To order: Specify the type of lock required, for a standard lock, add L3 to the product number; for a safety hasp, add LP to the product number



PRODUCT NO.	HEIGHT
RE80-18__A	18"
RE80-24__A	24"
RE80-30__A	30"
RE80-36__A	36"
RE80-48__A	48"

### LOCK-OUT MECHANISM

RF85

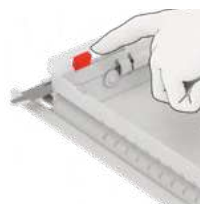

- For both drawers and roll-out shelves
- Locks drawers and roll-out shelves in an open position
- Activated manually, only when required
- Compatible with all drawer accessories
- Plastic bins in the back row may make it more difficult to activate the mechanism

PRODUCT NO.
RF85

### SECURITY PANEL

RF91



- Blocks access between two drawers or two banks of drawers
- Usable space in the bank of drawers is reduced by 1"
- Installs between two drawers
- To order: Complete the product number with the width required: 30", 36", 42" or 48"

PRODUCT NO.	DEPTH
RF91-__18	18"
RF91-__24	24"

### INTEGRATED LOCK-IN MECHANISM

A



- Automatically activated when lifting the handle up
- The drawer or roll-out shelf can be opened with one hand only
- Closes with a simple push
- Stops drawer or roll-out shelf from opening on their own
- Easy to retrofit
- To order: Add A to the product number for the drawer, preconfigured compartment layout or roll-out shelf, e.g., RF32-362406A
- For replacement parts or to retrofit this mechanism, order an RY08-WWA

PRODUCT NO.
<u>A</u>

### ECONO LOCK-IN MECHANISM

B



- Automatically activated when lifting the handle up
- The drawer or roll-out shelf can be opened with one hand only
- Closes with a simple push
- Stops drawer or roll-out shelf from opening on their own
- Easy to retrofit
- To order: Add B to the product number for the drawer, preconfigured compartment layout or roll-out shelf, e.g., RF32-362406B
- For replacement parts or to retrofit this mechanism, order an RY01-B

PRODUCT NO.
<u>B</u>

### DRAWER LOCK

L3



- Compatible with all drawer dimensions
- Does not reduce the drawer's storage space
- Easy to retrofit
- To order: Add L3 to the product number for the drawer or preconfigured compartment layout, e.g., RF32-362406L3
- For replacement parts or to retrofit this mechanism, order an RY01-L3

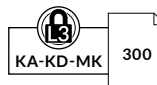

PRODUCT NO.
<u>L3</u>

## STRUCTURAL COMPONENTS

### POST



### SR10 / SH10



SH SR

- Tubular T shape provides up to seven fixing zones
- Includes perforations spaced 1" apart c/c on each side for easy adjustment of shelves
- 14ga steel
- Options:
  - SR10 universal post with perforated front surface for adding Mini-Racking or multi-level shelving
  - SH10 shelving post with smooth front surface for a neater finish

SR UNIVERSAL POST	SH SHELVING POST	HEIGHT
SR10-039	SH10-039	39"
SR10-051	SH10-051	51"
SR10-075	SH10-075	75"
SR10-087	SH10-087	87"
SR10-099	SH10-099	99"
SR10-111	SH10-111	111"
SR10-123	SH10-123	123"

NOTES: Other sizes are available. Contact your customer service representative for more information.

The unique design of the Spider® post is a trademark of Rousseau Metal Inc.

### WELDED OPEN UPRIGHT



### SR11 / SH11



- Upright with factory-welded side braces
- Enables faster assembly
- To order: Complete the product number with the depth required: 12", 15", 18" or 24"

SR UNIVERSAL POST	SH SHELVING POST	HEIGHT
SR11-__0752	SH11-__0752	75"
SR11-__0872	SH11-__0872	87"
SR11-__0992	SH11-__0992	99"

NOTE: Other sizes are available. Contact your customer service representative for more information.

### WELDED CLOSED UPRIGHT



### SR12 / SH12



- Upright with full-height factory-welded panel
- Enables faster assembly
- To order: Complete the product number with the depth required: 12", 15", 18" or 24"

SR UNIVERSAL POST	SH SHELVING POST	HEIGHT
SR12-__075	SH12-__075	75"
SR12-__087	SH12-__087	87"
SR12-__099	SH12-__099	99"

NOTE: Other sizes are available. Contact your customer service representative for more information.

### SHELF FRONT OR FRONT BASE

### SH28

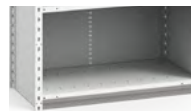

- Same component used for both applications
- Quick and easy hook-on installation
- To order: Complete the product number with the width required: 30", 36", 42" or 48"

PRODUCT NO.	HEIGHT
SH28-__02	2"
SH28-__05	5"

NOTE: The 2" front base is always included with closed shelving preconfigured models.

### SIDE PANEL

### SH30



- Panel combinations:
  - 75"H posts (39"H + 39"H)
  - 87"H posts (39"H + 51"H)
  - 99"H posts (51"H + 51"H)
  - 111"H posts (39"H + 39"H + 39"H)
  - 123"H posts (39"H + 39"H + 51"H)
- To order: Complete the product number with the depth required: 12", 15", 18" or 24"

PRODUCT NO.	HEIGHT
SH30-__39	39"
SH30-__51	51"

### BACK PANEL

### SH31



- Panel combinations:
  - 75"H posts (39"H + 39"H)
  - 87"H posts (39"H + 51"H)
  - 99"H posts (51"H + 51"H)
  - 111"H posts (39"H + 39"H + 39"H)
  - 123"H posts (39"H + 39"H + 51"H)
- To order: Complete the product number with the width required: 30", 36", 42" or 48"

PRODUCT NO.	HEIGHT
SH31-__39	39"
SH31-__51	51"

# COMPONENTS

## BACK SWAY BRACE SH33



- X-shaped factory-assembled brace
- Easy to install
- Recommendations:
  - For 99"H uprights and shorter: one brace
  - For uprights higher than 99": two braces, please refer to technical guide S58 or contact your customer service representative for exact placement of the brace

PRODUCT NO.	WIDTH
SH33-30	30"
SH33-36	36"
SH33-42	42"
SH33-48	48"

## SIDE BRACES SH34



- Sold in pairs
- Enables uprights to be attached in a "ladder" for easier assembly
- Recommendations:
  - For 99"H uprights or shorter: one pair of side braces
  - For uprights higher than 99"H: please refer to technical guide S58 or contact your customer service representative

PRODUCT NO.	DEPTH
SH34-12	12"
SH34-15	15"
SH34-18	18"
SH34-24	24"
SH34-30	30"

## CORNER GUSSETS SH35



- Replaces a back sway brace to provide full access to the front and rear of the shelving
- 14ga steel
- Each kit includes four gussets. Minimum of three kits required per shelving unit

PRODUCT NO.
SH35

NOTE: Not to be used for shelving over 99"H, multi-level shelving or SHC2 double shelf reinforcements.

## STRUCTURAL BACK UTILITY PANEL SH79

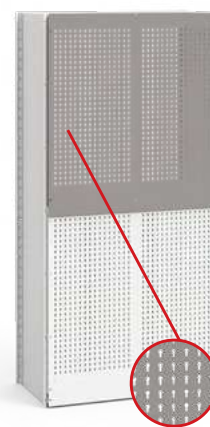

- Utility panel for the backs of shelving
- Forms an integral part of the shelving structure
- Holes spaced 1" apart c/c
- Load capacity: maximum 250lb. per panel
- Compatible with WM9F, WM9G, WM9H, WM9J and WM9L light-duty hooks, and WM9A and WM9B heavy-duty hooks
- Compatible with WM9C rails, and WM9D, WM9M, WM9N, WM9P and WM9Q holders
- Panel combinations:
  - 75"H posts (39"H + 39"H)
  - 87"H posts (39"H + 51"H)
  - 99"H posts (51"H + 51"H)
- To order: Complete the product number with the width required: 30", 36", 42" or 48"

PRODUCT NO.	HEIGHT
SH79-__39	39"
SH79-__51	51"

NOTE: Used without SH31 back panels.





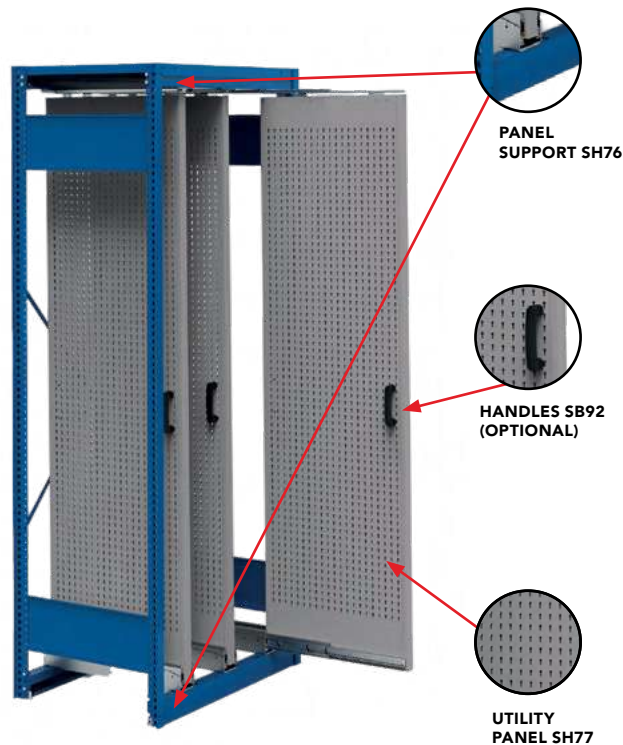

- For storing a wide range of items: tools, straps, cables, pipes, gaskets, etc.
- Compatible with Spider® shelving, both open and closed
- Refer to technical guide S84 for spacing between panels
- SB92 handles available as an optional add-on
- Panel:
  - Available heights: 63", 75" and 87"; depths: 18" and 24"
  - Holes spaced 1" apart c/c
  - Width adjustable in 1" increments c/c
  - Load capacity: 300lb. per panel (weight evenly distributed)
  - Compatible with WM9F, WM9G, WM9H, WM9J and WM9L light-duty hooks, and WM9A and WM9B heavy-duty hooks
  - Compatible with WM9C rails, and WM9D, WM9M, WM9N, WM9P and WM9Q holders
- Support:
  - Available widths: 30", 36", 42" and 48"
  - One support kit per shelving
  - The bottom beam also serves as a kick plate
  - To order: Specify the width of the support required

PRODUCT NO.	D×H	NO. OF HOLES
SH77-1863	18"×63"	15
SH77-2463	24"×63"	21
SH77-1875	18"×75"	15
SH77-2475	24"×75"	21
SH77-1887	18"×87"	15
SH77-2487	24"×87"	21
SH76-__	Panel support	
SB92-01	Handles	



The panel support must be anchored to the ground to ensure stability (anchoring kit included).

NOTES: If the shelving unit is used on its own, the sliding panels must be the same height as the shelving.  
If the shelving with sliding panels is used in combination with two shelving units, you can put storage shelves above the panels.

## INSTALLATION ACCESSORIES

### FLOOR ANCHOR PLATE

**SH45**

- Sold individually
- Attaches to the post for anchoring shelving sections to the ground. Distributes the load over a larger surface and protects the floor
- 12ga galvanized steel

**PRODUCT NO.**  
SH45

### SHIM PLATE

**SH46**

- Sold individually
- Levels shelving units on uneven surfaces
- Slides under SH45 floor anchor plates
- 12ga or 16ga galvanized steel

PRODUCT NO.	THICKNESS
SH46-12	12 gauge (0.100")
SH46-16	16 gauge (0.060")

### LEVELING GLIDE KIT

**SR49**

- Sold in pairs
- Adjusts the height of Spider® Shelving units from 1¼" to 2½" on uneven surfaces
- Load capacity: maximum 750lb. per glide
- Restrictions:
  - Only compatible with 99"H shelving or shorter
  - Only compatible with SR uprights and posts
  - Not compatible with RF32/RF36 modular drawers, RF41/RF45 roll-out shelves and SH28 bases

**PRODUCT NO.**  
SR49-01

### FLOOR ANCHORING HARDWARE

**SH47**

- Anchors shelving to the ground
- Includes four bolts for concrete floors

**PRODUCT NO.**  
SH47-04

### WALL SPACER

**SR47**

- Anchors shelving to the wall
- Adjusts from 3" to 4"
- Wall anchoring hardware not included (holes are 5/16" dia.)

**PRODUCT NO.**  
SR47-0304

## SHELVES AND SHELF ACCESSORIES

### BOX SHELF

SH20



SH60

- Box-type shelf with front and rear edges roll-formed and welded
- 20 gauge steel, 1¼" thick
- 4 sturdy and compact SH60 clips included
- Perforations for dividers (SH52) at every 3"c/c

PRODUCT NO.	W × D
SH20-3012	30" × 12"
SH20-3015	30" × 15"
SH20-3018	30" × 18"
SH20-3024	30" × 24"
SH20-3612	36" × 12"
SH20-3615	36" × 15"
SH20-3618	36" × 18"
SH20-3624	36" × 24"

PRODUCT NO.	W × D
SH20-4212	42" × 12"
SH20-4215	42" × 15"
SH20-4218	42" × 18"
SH20-4224	42" × 24"
SH20-4812	48" × 12"
SH20-4815	48" × 15"
SH20-4818	48" × 18"
SH20-4824	48" × 24"

NOTE: Other sizes are available. Contact your Customer Service representative for more information.

### SHELF LOAD CAPACITY

Shelving load capacity tests are based on ANSI MH28.1 Shelving Manufacturer Association (SMA) standards.

These load capacities include a safety factor and are valid for an evenly distributed load. The capacities specified are in pounds.

NOTE: SH22, SH24 and SHC reinforcements are not factory installed on SH20 BOX shelves.

DIMENSIONS W × D	SHELF REINFORCEMENT TYPES		
	MEDIUM-DUTY CAPACITY WITHOUT REINFORCEMENT	HEAVY-DUTY CAPACITY CENTRAL REINFORCEMENT	EXTRA HEAVY-DUTY CAPACITY DOUBLE REINFORCEMENT
30" × 12"	750	—	—
30" × 15"	775	—	—
30" × 18"	800	—	—
30" × 24"	450	—	—
36" × 12"	750	—	—
36" × 15"	775	—	—
36" × 18"	800	1000	1100
36" × 24"	625	1050	1100
42" × 12"	650	—	—
42" × 15"	650	—	—
42" × 18"	650	850	1050
42" × 24"	650	875	1050
48" × 12"	550	—	—
48" × 15"	550	—	—
48" × 18"	575	725	1025
48" × 24"	600	750	1050



## CENTER SHELF REINFORCEMENT (HEAVY-DUTY) SHC



- One SH24 front reinforcement combined with two SH22 side reinforcements
- Galvanized steel

PRODUCT NO.	W × D
SHC1009	30" × 18"
SHC1010	30" × 24"
SHC1003	36" × 18"
SHC1004	36" × 24"
SHC1007	42" × 18"
SHC1008	42" × 24"
SHC1005	48" × 18"
SHC1006	48" × 24"

## DOUBLE SHELF REINFORCEMENT (EXTRA HEAVY-DUTY) SHC



- Combination of two front reinforcements (SH24) with two side reinforcements (SH22);
- Galvanized steel.

PRODUCT NO.	W × D
SHC2009	30" × 18"
SHC2010	30" × 24"
SHC2003	36" × 18"
SHC2004	36" × 24"
SHC2007	42" × 18"
SHC2008	42" × 24"
SHC2005	48" × 18"
SHC2006	48" × 24"

NOTE: Required when the shelves need to support higher loads, concentrated loads or when aesthetics are important.

## SIDE SHELF REINFORCEMENTS SH22



- Two L-shaped reinforcements that attach on each side of the shelf
- These side reinforcements increase the load capacity of 36"W × 24"D shelves to 800lb.
- Galvanized steel

PRODUCT NO.	DEPTH
SH22-18	18"
SH22-24	24"

## FRONT SHELF REINFORCEMENT SH24



- C-shaped reinforcement
- Required when the shelves need to support loads concentrated at the front
- Galvanized steel

PRODUCT NO.	WIDTH
SH24-30	30"
SH24-36	36"
SH24-42	42"
SH24-48	48"

NOTE: This reinforcement increases rigidity, not load capacity.



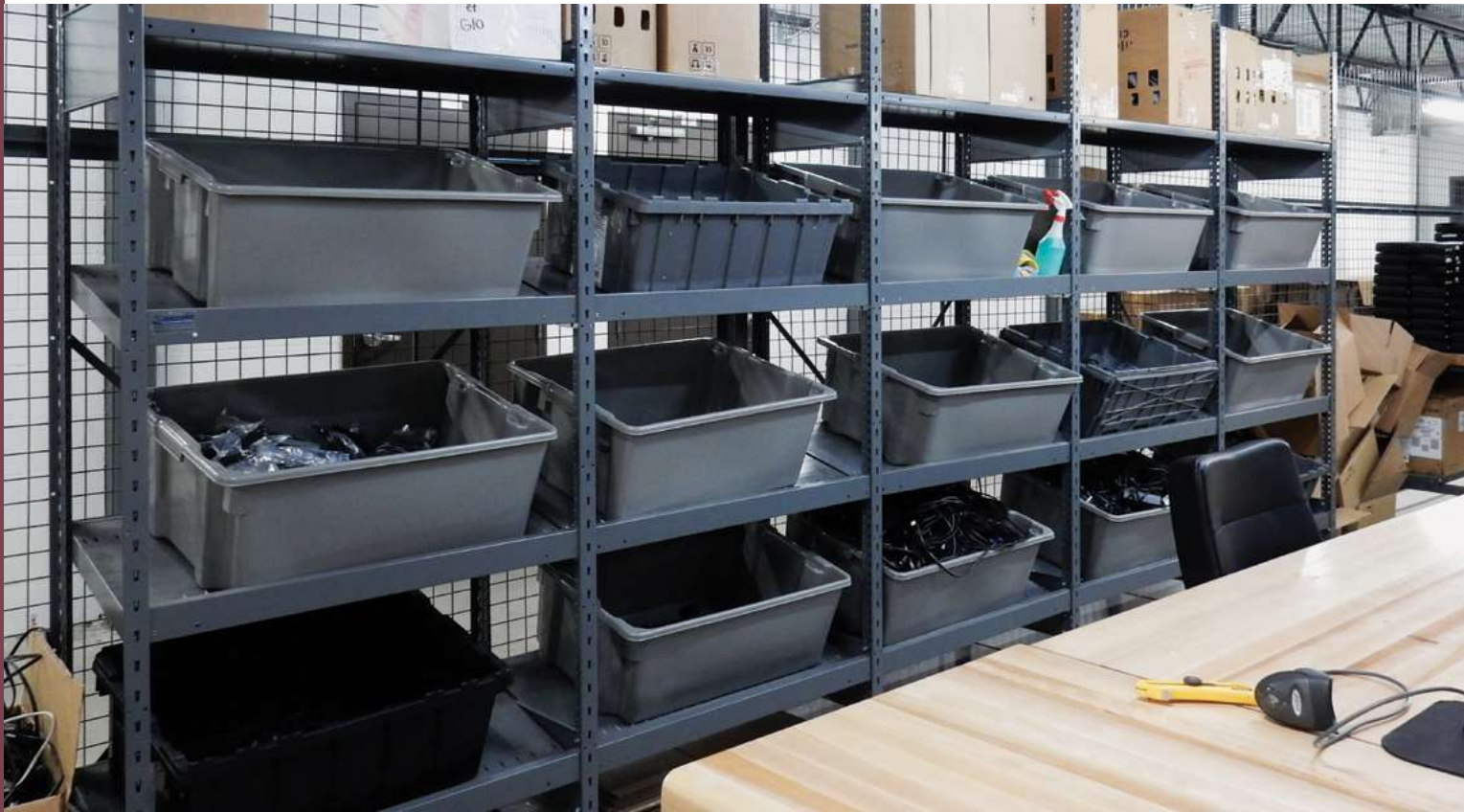

INDEX	PAGE(S)
Shelving with Sloped Shelves	106
Preconfigured Models . . .	107-109
Components . . . . .	110-113

## SHELVING WITH SLOPED SHELVES

Rousseau shelving with sloped shelves provides superior-quality gravity flow storage that integrates perfectly with other products in our Spider® range. This unique product on the market is available in a wide range of dimensions to fulfill your exact requirements.

With an average slope of 15 degrees, sloped shelves are perfect for rear-loading applications (flow rack). These units help to create a "first in, first out" (FIFO) system. Shelving units without rear access are also available for more conventional storage.

Sloped shelves provide optimum visibility for items stored on shelves above the user's eye level. For shelves below this level, the extra angle reduces visibility of the shelf contents. If visibility is more important than flow in your system, we recommend installing lower shelves at right angles (SH20 / 21).



SRE1F-EE750501 + SRG1F-EE750501



SRE1T-EE750502\*

**WHEN ORDERING, MODEL NUMBERS MUST BE COMPLETED AS FOLLOWS**

H for posts with a smooth surface  
R for posts with a perforated surface

S \_ \_ T-EE750401

1 for open shelving  
2 for closed shelving

SH SR  
BOLTED uprights  
WELDED uprights

Starter Unit  
D A  
E B

Add-on Unit

e.g., SHD1T - EE750401

For an open shelving starter unit with smooth surface posts, bolted uprights 36"W, 24"D, 75"H and with four sloped shelves.

NOTE: A sloped shelf (SH27) can be replaced with a right-angled BOX shelf (SH20/21), see page 110.

## OPEN AND CLOSED SHELVING

HERE ARE SOME OF OUR MOST POPULAR PRECONFIGURED MODELS OF SHELVING UNITS

- The preconfigured models in this section include open or closed uprights and sloped shelves
- The shelves have perforations for SH52 dividers and SH57 guides in 1½" increments c/c. Extra perforations have also been added on each side for aligning an SH52 divider or an SH57 guide with the side of the post (this part acts as a side edge and prevents interference between stored items and the post fold)
- SH52 dividers are available for 18"D and 24"D shelving only
- A sloped shelf can be replaced with a right-angled BOX shelf, see page 110
- The closed shelving preconfigured models in this section include back panels and a front base
- The open shelving preconfigured models in this section include a back brace

### OPEN SHELVING



SRE1T-EE750501  
Starter unit



SRB1T-EE750501  
Add-on unit

### CLOSED SHELVING



SRE2T-EE750501  
Starter unit



SRB2T-EE750501  
Add-on unit

DIMENSIONS			NUMBER OF SHELVES			
W	D	H	4	5	6	
36"	18"	75"	S _ _ T-EC750401	S _ _ T-EC750501	S _ _ T-EC750601	
	24"		S _ _ T-EE750401	S _ _ T-EE750501	S _ _ T-EE750601	
	30"		S _ _ T-EH750401	S _ _ T-EH750501	S _ _ T-EH750601	
	36"		S _ _ T-EJ750401	S _ _ T-EJ750501	S _ _ T-EJ750601	
	18"		87"	S _ _ T-EC870401	S _ _ T-EC870501	S _ _ T-EC870601
	24"			S _ _ T-EE870401	S _ _ T-EE870501	S _ _ T-EE870601
	30"	S _ _ T-EH870401		S _ _ T-EH870501	S _ _ T-EH870601	
	36"	S _ _ T-EJ870401		S _ _ T-EJ870501	S _ _ T-EJ870601	
	18"	99"		S _ _ T-EC990401	S _ _ T-EC990501	S _ _ T-EC990601
	24"			S _ _ T-EE990401	S _ _ T-EE990501	S _ _ T-EE990601
	30"		S _ _ T-EH990401	S _ _ T-EH990501	S _ _ T-EH990601	
	36"		S _ _ T-EJ990401	S _ _ T-EJ990501	S _ _ T-EJ990601	
42"	18"		75"	S _ _ T-GC750401	S _ _ T-GC750501	S _ _ T-GC750601
	24"			S _ _ T-GE750401	S _ _ T-GE750501	S _ _ T-GE750601
	30"	S _ _ T-GH750401		S _ _ T-GH750501	S _ _ T-GH750601	
	36"	S _ _ T-GJ750401		S _ _ T-GJ750501	S _ _ T-GJ750601	
	18"	87"		S _ _ T-GC870401	S _ _ T-GC870501	S _ _ T-GC870601
	24"			S _ _ T-GE870401	S _ _ T-GE870501	S _ _ T-GE870601
	30"		S _ _ T-GH870401	S _ _ T-GH870501	S _ _ T-GH870601	
	36"		S _ _ T-GJ870401	S _ _ T-GJ870501	S _ _ T-GJ870601	
	18"		99"	S _ _ T-GC990401	S _ _ T-GC990501	S _ _ T-GC990601
	24"			S _ _ T-GE990401	S _ _ T-GE990501	S _ _ T-GE990601
	30"	S _ _ T-GH990401		S _ _ T-GH990501	S _ _ T-GH990601	
	36"	S _ _ T-GJ990401		S _ _ T-GJ990501	S _ _ T-GJ990601	
48"	18"	75"		S _ _ T-HC750401	S _ _ T-HC750501	S _ _ T-HC750601
	24"			S _ _ T-HE750401	S _ _ T-HE750501	S _ _ T-HE750601
	30"		S _ _ T-HH750401	S _ _ T-HH750501	S _ _ T-HH750601	
	36"		S _ _ T-HJ750401	S _ _ T-HJ750501	S _ _ T-HJ750601	
	18"		87"	S _ _ T-HC870401	S _ _ T-HC870501	S _ _ T-HC870601
	24"			S _ _ T-HE870401	S _ _ T-HE870501	S _ _ T-HE870601
	30"	S _ _ T-HH870401		S _ _ T-HH870501	S _ _ T-HH870601	
	36"	S _ _ T-HJ870401		S _ _ T-HJ870501	S _ _ T-HJ870601	
	18"	99"		S _ _ T-HC990401	S _ _ T-HC990501	S _ _ T-HC990601
	24"			S _ _ T-HE990401	S _ _ T-HE990501	S _ _ T-HE990601
	30"		S _ _ T-HH990401	S _ _ T-HH990501	S _ _ T-HH990601	
	36"		S _ _ T-HJ990401	S _ _ T-HJ990501	S _ _ T-HJ990601	

# PRECONFIGURED MODELS

## BACK-TO-BACK OPEN AND CLOSED SHELVING

HERE ARE SOME OF OUR MOST POPULAR PRECONFIGURED MODELS OF SHELVING UNITS

- The preconfigured models in this section include open or closed uprights and sloped shelves
- The shelves have perforations for SH52 dividers and SH57 guides in 1½" increments c/c. Extra perforations have also been added on each side for aligning an SH52 divider or an SH57 guide with the side of the post (this part acts as a side edge and prevents interference between stored items and the post fold)
- SH52 dividers are available for 18"D and 24"D shelving only
- A sloped shelf can be replaced with a right-angled BOX shelf, [see page 110](#)
- The closed shelving preconfigured models in this section include back panels and front bases
- The open shelving preconfigured models in this section include a back brace

### OPEN SHELVING



SRE1T-EE751001B  
Starter unit

SRB1T-EE751001B  
Add-on unit

### CLOSED SHELVING



SRE2T-EE751001B  
Starter unit

SRB2T-EE751001B  
Add-on unit

DIMENSIONS			NUMBER OF SHELVES		
W	D*	H	8	10	12
36"	75"	36"	S__T-EC750801B	S__T-EC751001B	S__T-EC751201B
		48"	S__T-EE750801B	S__T-EE751001B	S__T-EE751201B
		60"	S__T-EH750801B	S__T-EH751001B	S__T-EH751201B
		72"	S__T-EJ750801B	S__T-EJ751001B	S__T-EJ751201B
	87"	36"	S__T-EC870801B	S__T-EC871001B	S__T-EC871201B
		48"	S__T-EE870801B	S__T-EE871001B	S__T-EE871201B
		60"	S__T-EH870801B	S__T-EH871001B	S__T-EH871201B
		72"	S__T-EJ870801B	S__T-EJ871001B	S__T-EJ871201B
	99"	36"	S__T-EC990801B	S__T-EC991001B	S__T-EC991201B
		48"	S__T-EE990801B	S__T-EE991001B	S__T-EE991201B
		60"	S__T-EH990801B	S__T-EH991001B	S__T-EH991201B
		72"	S__T-EJ990801B	S__T-EJ991001B	S__T-EJ991201B
42"	75"	36"	S__T-GC750801B	S__T-GC751001B	S__T-GC751201B
		48"	S__T-GE750801B	S__T-GE751001B	S__T-GE751201B
		60"	S__T-GH750801B	S__T-GH751001B	S__T-GH751201B
		72"	S__T-GJ750801B	S__T-GJ751001B	S__T-GJ751201B
	87"	36"	S__T-GC870801B	S__T-GC871001B	S__T-GC871201B
		48"	S__T-GE870801B	S__T-GE871001B	S__T-GE871201B
		60"	S__T-GH870801B	S__T-GH871001B	S__T-GH871201B
		72"	S__T-GJ870801B	S__T-GJ871001B	S__T-GJ871201B
	99"	36"	S__T-GC990801B	S__T-GC991001B	S__T-GC991201B
		48"	S__T-GE990801B	S__T-GE991001B	S__T-GE991201B
		60"	S__T-GH990801B	S__T-GH991001B	S__T-GH991201B
		72"	S__T-GJ990801B	S__T-GJ991001B	S__T-GJ991201B
48"	75"	36"	S__T-HC750801B	S__T-HC751001B	S__T-HC751201B
		48"	S__T-HE750801B	S__T-HE751001B	S__T-HE751201B
		60"	S__T-HH750801B	S__T-HH751001B	S__T-HH751201B
		72"	S__T-HJ750801B	S__T-HJ751001B	S__T-HJ751201B
	87"	36"	S__T-HC870801B	S__T-HC871001B	S__T-HC871201B
		48"	S__T-HE870801B	S__T-HE871001B	S__T-HE871201B
		60"	S__T-HH870801B	S__T-HH871001B	S__T-HH871201B
		72"	S__T-HJ870801B	S__T-HJ871001B	S__T-HJ871201B
	99"	36"	S__T-HC990801B	S__T-HC991001B	S__T-HC991201B
		48"	S__T-HE990801B	S__T-HE991001B	S__T-HE991201B
		60"	S__T-HH990801B	S__T-HH991001B	S__T-HH991201B
		72"	S__T-HJ990801B	S__T-HJ991001B	S__T-HJ991201B

NOTE: \* The depth includes two units. e.g., 36"D = two 18"D units



SRK1F-EE750502\*

**WHEN ORDERING, MODEL NUMBERS MUST BE COMPLETED AS FOLLOWS**

	Standalone Unit	Starter Unit	Add-on Unit	End Unit
BOLTED uprights	J	D	A	C
WELDED uprights	K	E	B	G

↓

SR\_1F-EE750401

e.g., SRJ1F - EE750401

For an open shelving standalone unit with perforated posts, bolted uprights 36"W, 24"D, 75"H and with four sloped shelves.

NOTE: A sloped shelf (SH27) can be replaced with a right-angled BOX shelf (SH20/21), see page 110.

## FIFO OPEN SHELVING

HERE ARE SOME OF OUR MOST POPULAR PRECONFIGURED MODELS OF SHELVING UNITS

- The preconfigured models in this section include open uprights and sloped shelves. These preconfigured models include two dividing guides per shelf. The guides can be adjusted in 1½" increments c/c.
- The shelves have perforations for SH52 dividers and SH57 guides in 1½" increments c/c. Extra perforations have also been added on each side for aligning an SH52 divider or an SH57 guide with the side of the post (this part acts as a side edge and prevents interference between stored items and the post fold)
- SH52 dividers are available for 18"D and 24"D shelving only
- A sloped shelf can be replaced with a right-angled BOX shelf, see page 110
- These preconfigured models include single or double corner gussets (depending on configuration)



SRK1F-DC750401  
Standalone Unit



SRE1F-DC75041 Starter unit    SRB1F-DC750401 Add-on unit    SRG1F-DC750401 End unit

DIMENSIONS			NUMBER OF SHELVES		
W	D	H	4	5	6
36"	18"	75"	SR_1F-EC750401	SR_1F-EC750501	SR_1F-EC750601
	24"		SR_1F-EE750401	SR_1F-EE750501	SR_1F-EE750601
	30"		SR_1F-EH750401	SR_1F-EH750501	SR_1F-EH750601
	36"		SR_1F-EJ750401	SR_1F-EJ750501	SR_1F-EJ750601
	18"	87"	SR_1F-EC870401	SR_1F-EC870501	SR_1F-EC870601
	24"		SR_1F-EE870401	SR_1F-EE870501	SR_1F-EE870601
	30"		SR_1F-EH870401	SR_1F-EH870501	SR_1F-EH870601
	36"		SR_1F-EJ870401	SR_1F-EJ870501	SR_1F-EJ870601
	18"	99"	SR_1F-EC990401	SR_1F-EC990501	SR_1F-EC990601
	24"		SR_1F-EE990401	SR_1F-EE990501	SR_1F-EE990601
	30"		SR_1F-EH990401	SR_1F-EH990501	SR_1F-EH990601
	36"		SR_1F-EJ990401	SR_1F-EJ990501	SR_1F-EJ990601
42"	18"	75"	SR_1F-GC750401	SR_1F-GC750501	SR_1F-GC750601
	24"		SR_1F-GE750401	SR_1F-GE750501	SR_1F-GE750601
	30"		SR_1F-GH750401	SR_1F-GH750501	SR_1F-GH750601
	36"		SR_1F-GJ750401	SR_1F-GJ750501	SR_1F-GJ750601
	18"	87"	SR_1F-GC870401	SR_1F-GC870501	SR_1F-GC870601
	24"		SR_1F-GE870401	SR_1F-GE870501	SR_1F-GE870601
	30"		SR_1F-GH870401	SR_1F-GH870501	SR_1F-GH870601
	36"		SR_1F-GJ870401	SR_1F-GJ870501	SR_1F-GJ870601
	18"	99"	SR_1F-GC990401	SR_1F-GC990501	SR_1F-GC990601
	24"		SR_1F-GE990401	SR_1F-GE990501	SR_1F-GE990601
	30"		SR_1F-GH990401	SR_1F-GH990501	SR_1F-GH990601
	36"		SR_1F-GJ990401	SR_1F-GJ990501	SR_1F-GJ990601
48"	18"	75"	SR_1F-HC750401	SR_1F-HC750501	SR_1F-HC750601
	24"		SR_1F-HE750401	SR_1F-HE750501	SR_1F-HE750601
	30"		SR_1F-HH750401	SR_1F-HH750501	SR_1F-HH750601
	36"		SR_1F-HJ750401	SR_1F-HJ750501	SR_1F-HJ750601
	18"	87"	SR_1F-HC870401	SR_1F-HC870501	SR_1F-HC870601
	24"		SR_1F-HE870401	SR_1F-HE870501	SR_1F-HE870601
	30"		SR_1F-HH870401	SR_1F-HH870501	SR_1F-HH870601
	36"		SR_1F-HJ870401	SR_1F-HJ870501	SR_1F-HJ870601
	18"	99"	SR_1F-HC990401	SR_1F-HC990501	SR_1F-HC990601
	24"		SR_1F-HE990401	SR_1F-HE990501	SR_1F-HE990601
	30"		SR_1F-HH990401	SR_1F-HH990501	SR_1F-HH990601
	36"		SR_1F-HJ990401	SR_1F-HJ990501	SR_1F-HJ990601

# COMPONENTS

## SHELVES AND SHELF ACCESSORIES

### SLOPED SHELF

SH27



- For gravity flow storage ("first in, first out" – FIFO)
- Approx. 15° angle slope
- Includes a heavy-duty front edge to keep stored items in place. Front edge height: 1 3/4"
- 20ga steel shelves (painted steel)
- Shelf is placed on galvanized steel side supports (included)
- Includes perforations for SH52 dividers and SH57 dividing guides in 1 1/2" increments c/c
- SH52 dividers are available for 18"D and 24"D shelving only
- Extra perforations have been added to the sides to optimize alignment of the divider or guide with the post and to prevent stored items from falling
- Height can be adjusted in 1" increments, except if SR35 or SR36 corner gussets are used (in which case, can be adjusted in 2" increments)
- Sloped shelves and non-sloped SH20 and SH21 BOX shelves can be combined in the same unit

- Sloped shelf load capacity: 450lb.
- Compatible with:
  - SH99 base for mobile shelving
  - SH41, SH43, SH91 and SH93 doors with frame\*
  - SH85 flipper door directly underneath an SH27 shelf\*
  - Drawers directly underneath an SH27 shelf\*
  - SH28 base
  - SH81 and SH82 label holders
  - SH37, SH38, SH66, SH68, SH69 and SR79 panels

PRODUCT NO.	W x D	PRODUCT NO.	W x D
SH27-3018	30" x 18"	SH27-4218	42" x 18"
SH27-3024	30" x 24"	SH27-4224	42" x 24"
SH27-3030	30" x 30"	SH27-4230	42" x 30"
SH27-3036	30" x 36"	SH27-4236	42" x 36"
SH27-3618	36" x 18"	SH27-4818	48" x 18"
SH27-3624	36" x 24"	SH27-4824	48" x 24"
SH27-3630	36" x 30"	SH27-4830	48" x 30"
SH27-3636	36" x 36"	SH27-4836	48" x 36"

NOTES: Not compatible with the following products: SH50 divider, SH56 dividing rod, SH65 and SH67 panels for plastic bins, SH35 corner gussets.

\*Not compatible with SR35 and SR36 corner gussets.

One SH2A reinforcements increase the BOX shelf's rigidity (but do not increase the shelf's load capacity).

### BOX SHELF

SH20 / SH21



SH60

- BOX-type shelf with roll-formed and welded front and back edges
- 20ga steel. Thickness: 1 3/4"
- Includes four sturdy and compact SH60 clips
- Includes perforations spaced 3" apart c/c for installing SH52 dividers
- SH52 dividers are available for 18"D and 24"D shelving only
- To order: Complete the product number with the width required: 30", 36", 42" or 48"
- SH20: Reinforcements are available for these shelves. For load capacities, [see page 110](#)
- SH21: To see load capacities and shelf reinforcements available, refer to the following table

PRODUCT NO.	DEPTH
SH20-__18	18"
SH20-__24	24"
SH21-__30*	30"
SH21-__36*	36"

NOTE: \* Double bend on the sides.

#### SH21 SHELF LOAD CAPACITY

Visual distortion is reduced if an SH26 reinforcement and two SH23 reinforcements are used on the shelf.

SHELVES	CAPACITY WITHOUT REINFORCEMENT	CAPACITY WITH SH23 REINFORCEMENT	CAPACITY WITH SH23 & SH26 REINFORCEMENT
SH21-3030	575	925	—
SH21-3036	425	825	—
SH21-3630	600	800	—
SH21-3636	425	800	—
SH21-4230	625	—	850
SH21-4236	525	—	775
SH21-4830	500	—	800
SH21-4836	500	—	800



## GUIDES



- Guides for sloped shelves (version 01) can be used to guide items all the way down the shelf
  - Width can be adjusted in 1½" increments
  - The front of the guide slots into the bend at the front of the shelf
  - The guide is held at the back by a plastic end piece that screws into the shelf holes
  - 18"D and 24"D guides use aluminum rods, while 30"D and 36"D guides use stainless steel rods

- Dividing guides for BOX shelves (version 02) can be used to separate items
  - Width can be adjusted in 3" increments
  - The guide is held at the front and back by a plastic end piece that screws into the shelf holes
  - 18"D and 24"D guides use aluminum rods, while 30"D and 36"D guides use stainless steel rods
- Heavy-duty black plastic end pieces

DIMENSIONS	PRODUCT NO.	
	SLOPED SHELF	BOX SHELF
18"	SH57-1801	SH57-1802
24"	SH57-2401	SH57-2402
30"	SH57-3001	SH57-3002
36"	SH57-3601	SH57-3602

## STRUCTURAL COMPONENTS

### POST



SR10 / SH10



- Tubular T shape provides up to seven fixing zones
- Includes perforations spaced 1" apart c/c on each side for easy adjustment of shelves
- 14ga steel
- Options:
  - SR10 universal post with perforated front surface for adding mini-racking units. Compatible with SR35 and SR36 corner gussets
  - SH10 shelving post with smooth front surface for a neater finish. Not compatible with SR35 and SR36 corner gussets

SR UNIVERSAL POST	SH SHELVING POST	HEIGHT
SR10-039	SH10-039	39"
SR10-051	SH10-051	51"
SR10-075	SH10-075	75"
SR10-087	SH10-087	87"
SR10-099	SH10-099	99"
SR10-111	SH10-111	111"
SR10-123	SH10-123	123"

NOTES: The maximum height for FIFO use (with SR35 and SR36 corner gussets) is 99". The unique design of the Spider® post is a trademark of Rousseau Metal Inc.



### WELDED OPEN UPRIGHT



SR11 / SH11



- Upright with factory-welded side braces
- Enables faster assembly
- To order: Complete the product number with the depth required: 18", 24", 30" or 36"
- Options:
  - SR11 open upright with perforated front surface for adding mini-racking units. Compatible with SR35 and SR36 corner gussets
  - SH11 open upright with smooth front surface for a neater finish. Not compatible with SR35 and SR36 corner gussets

SR UNIVERSAL POST	SH SHELVING POST	HEIGHT
SR11-__0752	SH11-__0752	75"
SR11-__0872	SH11-__0872	87"
SR11-__0992	SH11-__0992	99"

NOTE: The maximum height for FIFO use (with SR35/SR36 corner gussets) is 99".

### WELDED CLOSED UPRIGHT



SR12 / SH12



- Upright with full-height factory-welded panel
- Enables faster assembly
- To order: Complete the product number with the depth required: 18", 24", 30" or 36"
- Options:
  - SR12 closed upright with perforated front surface for adding mini-racking units. Compatible with SR35 and SR36 corner gussets
  - SH12 closed upright with smooth front surface for a neater finish. Not compatible with SR35 and SR36 corner gussets

SR UNIVERSAL POST	SH SHELVING POST	HEIGHT
SR12-__075	SH12-__075	75"
SR12-__087	SH12-__087	87"
SR12-__099	SH12-__099	99"

NOTE: The maximum height for FIFO use (with SR35 and SR36 corner gussets) is 99".

# COMPONENTS

## SHELF FRONT OR FRONT BASE

SH28

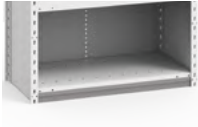

- Same component used for both applications
- Quick and easy hook-on installation
- To order: Complete the product number with the width required: 30", 36", 42" or 48"

PRODUCT NO.	HEIGHT
SH28-__02	2"
SH28-__05	5"

NOTE: The 2"H front base is always included with closed shelving preconfigured models (except the ones with sliding panels).

## SIDE PANEL

SH30

- Panel combinations:
  - 75"H posts (39"H + 39"H)
  - 87"H posts (39"H + 51"H)
  - 99"H posts (51"H + 51"H)
  - 111"H posts (39"H + 39"H + 39"H)
  - 123"H posts (39"H + 39"H + 51"H)
- To order: Complete the product number with the depth required: 18", 24", 30" or 36"

PRODUCT NO.	HEIGHT
SH30-__39	39"
SH30-__51	51"

## BACK PANEL

SH31

- Panel combinations:
  - 75"H posts (39"H + 39"H)
  - 87"H posts (39"H + 51"H)
  - 99"H posts (51"H + 51"H)
  - 111"H posts (39"H + 39"H + 39"H)
  - 123"H posts (39"H + 39"H + 51"H)
- To order: Complete the product number with the width required: 30", 36", 42" or 48"

PRODUCT NO.	HEIGHT
SH31-__39	39"
SH31-__51	51"

## BACK SWAY BRACE

SH33

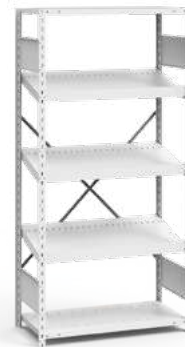

- X-shaped factory-assembled brace
- Easy to install
- Recommendations:
  - For 99"H uprights and shorter: one brace
  - For uprights higher than 99": two braces

PRODUCT NO.	WIDTH
SH33-30	30"
SH33-36	36"
SH33-42	42"
SH33-48	48"

NOTES: Please refer to technical guide S58 or contact your customer service representative for exact placement of the brace.  
Do not use with FIFO shelving. Replace with SR35 and SR36 corner gusset kits.

## SIDE BRACES

SH34

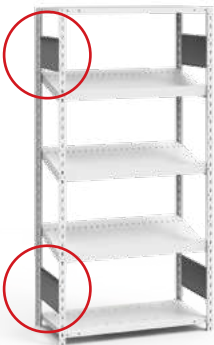

- Sold in pairs
- Enables uprights to be attached in a "ladder" for easier assembly
- Recommendations:
  - 99"H uprights or shorter: one pair of side braces
  - For uprights higher than 99"H: please refer to technical guide S58 or contact your customer service representative

PRODUCT NO.	DEPTH
SH34-18	18"
SH34-24	24"
SH34-30	30"
SH34-36	36"

## SINGLE CORNER GUSSET KIT

SR35



- Replaces a back sway brace to provide full access to the front and rear of the shelving
- For use with an end-of-aisle post or a common post with shelves side by side and offset by at least 4" in height
- Does not allow two shelves side by side at the same height
- Installs at the front and back of the post Compatible with SH20, SH21 and SH27 shelves
- For use with SR uprights and posts only
- Not compatible with doors with frame, drawers, roll-out shelves and flipper doors

PRODUCT NO.	
SR35-02	1 pair
SR35-04	2 pairs

NOTES: A minimum of three kits of two SR35 or SR36 gussets per post is required to provide proper lateral bracing.  
Not to be used for shelving over 99"H, multi-level shelving or double shelf reinforcements (SHC2).

## DOUBLE CORNER GUSSET KIT SR36



- Replaces sway brace to provide full access to the front and rear of the shelving
- For use with a common post with shelves side by side at the same height
- Installs at the front and back of the post
- Compatible with SH20, SH21 and SH27 shelves
- For use with SR uprights and posts only
- Not compatible with doors with frame, drawers, roll-out shelves and flipper doors

PRODUCT NO.	
SR36-02	1 pair

**NOTES:** A minimum of three kits of two SR35 or SR36 gussets per common post is required to provide proper lateral bracing.  
Not to be used for shelving over 99"H, multi-level shelving or double shelf reinforcements (SHC2).

## STRUCTURAL BACK UTILITY PANEL SH79

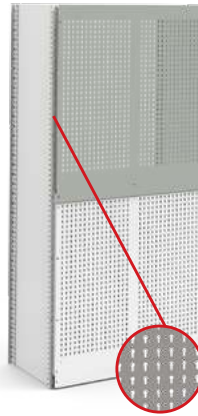

- Utility panel for the backs of shelving
- Forms an integral part of the shelving structure
- Holes spaced 1" apart c/c
- Load capacity: maximum 250lb. per panel
- Compatible with WM9F, WM9G, WM9H, WM9J and WM9L light-duty hooks, and WM9A and WM9B heavy-duty hooks
- Compatible with WM9C rails, and WM9D, WM9M, WM9N, WM9P and WM9Q holders
- Panel combinations:
  - 75"H posts (39"H + 39"H)
  - 87"H posts (39"H + 51"H)
  - 99"H posts (51"H + 51"H)
- To order: Complete the product number with the width required: 30", 36", 42" or 48"

PRODUCT NO.	HEIGHT
SH79-__39	39"
SH79-__51	51"

**NOTE:** Used without SH31 back panels.

## INSTALLATION ACCESSORIES

### FLOOR ANCHOR PLATE SH45



- Sold individually
- Attaches to the post for anchoring shelving sections to the ground. Distributes the load over a larger surface and protects the floor
- 12ga galvanized steel

PRODUCT NO.
SH45

### WALL SPACER SR47



- Anchors shelving to the wall
- Adjusts from 3" to 4"
- Wall anchoring hardware not included (holes are 5/16" dia.)

PRODUCT NO.
SR47-0304

### SHIM PLATE SH46



- Sold individually
- Levels shelving units on uneven surfaces  
Slides under SH45 floor anchor plates
- 12ga or 16ga galvanized steel

PRODUCT NO.	THICKNESS
SH46-12	12 gauge (0.100")
SH46-16	16 gauge (0.060")

### LEVELING GLIDES KIT SR49



- Sold in pairs
- Adjusts the height of Spider® Shelving units from 1¼" to 2½" on uneven surfaces
- Load capacity: maximum 750lb. per glide
- Restrictions:
  - Only compatible with 99"H shelving or shorter
  - Only compatible with SR uprights and posts
  - Not compatible with RF32 and RF36 modular drawers, RF41 and RF45 roll-out shelves and SH28 bases

PRODUCT NO.
SR49-01

### FLOOR ANCHORING HARDWARE SH47



- Used for anchoring shelving to the floor;
- Includes 4 cement screws.

PRODUCT NO.
SH47-04



INDEX	PAGE(S)
Mini-Racking	114-115
Preconfigured Models . . .	116-118
Accessories . . . . .	119-121
Components . . . . .	122-125

## SPIDER® MINI-RACKING SYSTEM

With a wide range of dimensions and options available, industrial-quality Rousseau Mini-Racking units offer an efficient way to store bulky items in a scalable system that easily adapts to specific needs.

The Spider® Mini-Racking system is heavy duty, easy to assemble, and is the most versatile and complete solution of its type on the market.

Designed for intensive use, the system helps you to use the space you have available to its full potential, in areas such as warehouses, repair shops and distribution centers.

**LIFETIME WARRANTY**  
 The Rousseau drawer rolling mechanism is covered by a lifetime warranty.



R5XEC-2004

## THE ROUSSEAU DIFFERENCE



Steel beams designed for several decking types: steel, wire mesh and wood.



The distinctive "claw" at the end of each beam hooks onto the front of the posts for extra structural rigidity and incredibly fast assembly.

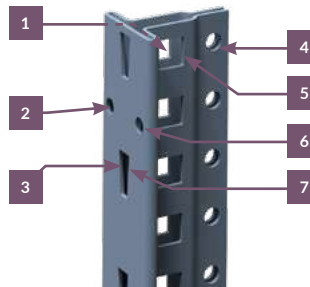

The common post is compatible with Mini-Racking and industrial shelving.



Using a combination of modular drawers with a shelving unit joined to the Mini-Racking structure, bulky items and small parts can be stored together, see pages 91-92.

NOTE: The unique design of the Spider® post is a trademark of Rousseau Metal Inc.

## GENERAL DIMENSIONS



SRE5127S

NOTE: Popular dimensions are shown in red.

# PRECONFIGURED MODELS



**WHEN ORDERING, MODEL NUMBERS MUST BE COMPLETED AS FOLLOWS**

BOLTED uprights WELDED uprights	Starter Unit	Add-on Unit	<u>S</u> Steel decking <u>W</u> Wire mesh decking . Without decking
	D	A	
	E	B	

SR\_5001\_

e.g., SRD5001S  
For a starter unit with bolted uprights and steel decking.

## MINI-RACKING WITH CHOICE OF DECKING

The beams are designed to support steel shelves (SR40, SH20), wire mesh decking (SR42) or wood panels at least 5/8" thick.

### STEEL

- To order a unit with steel decking, add S to the product number

### WIRE

- To order a unit with wire mesh decking, add W to the product number
- Not compatible with 18"D units

### FOR WOOD PANELS

- To order a unit without decking (e.g., for use with wood decking), leave the product number as is



SRE5127S  
Starter unit



SRB5127S  
Add-on unit



SRE5127W  
Starter unit



SRB5127W  
Add-on unit



SRE5127  
Starter unit



SRB5127  
Add-on unit



## MINI-RACKING WITH MEDIUM-DUTY BEAMS

DIMENSIONS			NO. OF DECKING LEVELS	
W	D	H	3	4
48"	18"	75"	SR_5001_	SR_5021_
	24"		SR_5002_	SR_5022_
	36"*		SR_5003_	SR_5023_
	48"*		SR_5004_	SR_5024_
	18"	87"	SR_5005_	SR_5025_
	24"		SR_5006_	SR_5026_
	36"*		SR_5007_	SR_5027_
	48"*		SR_5008_	SR_5028_
60"	18"	75"	SR_5051_	SR_5071_
	24"		SR_5052_	SR_5072_
	36"*		SR_5053_	SR_5073_
	48"*		SR_5054_	SR_5074_
	18"	87"	SR_5055_	SR_5075_
	24"		SR_5056_	SR_5076_
	36"*		SR_5057_	SR_5077_
	48"*		SR_5058_	SR_5078_
24"	99"	—	SR_5080_	
36"*		—	SR_5081_	
48"*		—	SR_5082_	
—		—	—	—
72"	18"	75"	SR_5101_	SR_5121_
	24"		SR_5102_	SR_5122_
	36"*		SR_5103_	SR_5123_
	48"*		SR_5104_	SR_5124_
	18"	87"	SR_5105_	SR_5125_
	24"		SR_5106_	SR_5126_
	36"*		SR_5107_	SR_5127_
	48"*		SR_5108_	SR_5128_
	24"	99"	—	SR_5130_
	36"*		—	SR_5131_
	48"*		—	SR_5132_
	—		—	—

NOTE: \*Mini-Racking units in these sizes can be joined to back-to-back shelving units of the same depth.

### TIE BARS

- Preconfigured models include one to three tie bars depending on their dimensions.

DEPTH	NO. OF TIE BARS		
	STEEL	WIRE MESH	WOOD
18"	1	NA	1
24"	1	1	1
36"	1	1	2
48"	1	1	3

NOTE: For load capacity table, see page 123.

## MINI-RACKING WITH HEAVY-DUTY BEAMS

DIMENSIONS			NO. OF DECKING LEVELS	
W	D	H	3	4
48"	18"	75"	SR_5151_	SR_5171_
	24"		SR_5152_	SR_5172_
	36"*		SR_5153_	SR_5173_
	48"*		SR_5154_	SR_5174_
	18"	87"	SR_5155_	SR_5175_
	24"		SR_5156_	SR_5176_
	36"*		SR_5157_	SR_5177_
	48"*		SR_5158_	SR_5178_
24"	99"	—	SR_5180_	
36"*		—	SR_5181_	
48"*		—	SR_5182_	
—		—	—	—
96"	18"	75"	SR_5201_	SR_5221_
	24"		SR_5202_	SR_5222_
	36"*		SR_5203_	SR_5223_
	48"*		SR_5204_	SR_5224_
	18"	87"	SR_5205_	SR_5225_
	24"		SR_5206_	SR_5226_
	36"*		SR_5207_	SR_5227_
	48"*		SR_5208_	SR_5228_
	24"	99"	—	SR_5230_
	36"*		—	SR_5231_
	48"*		—	SR_5232_
	—		—	—

NOTE: \*Mini-Racking units in these sizes can be joined to back-to-back shelving units of the same depth.

### TIE BARS

- Preconfigured models include one to three tie bars depending on their dimensions

WIDTH	DEPTH	NO. OF TIE BARS		
		STEEL	WIRE MESH	WOOD
72"	18"	1	NA	2
	24"	1	1	2
	36"	1	1	3
	48"	1	1	3
96"	18"	1	NA	2
	24"	1	1	2
	36"	1	1	3
	48"	2	2	3

NOTE: For load capacity table, see page 123.

# PRECONFIGURED MODELS

## MINI-RACKING FOR STANDARD-SIZED WOOD DECKING



SRD7031  
Starter unit



SRA7031  
Add-on unit

### MINI-RACKING FOR STANDARD-SIZED WOOD DECKING

- These dimensions are designed to limit the need to cut the wood decking
- Four long-span levels with heavy-duty beams
- Bolted uprights (requires assembly)

STARTER UNIT	ADD-ON UNIT	W×D×H
SRD7031	SRA7031	72" × 48½" × 87"
SRD7032	SRA7032	72" × 48½" × 99"
SRD7033	SRA7033	96½" × 24" × 87"
SRD7034	SRA7034	96½" × 24" × 99"
SRD7035	SRA7035	96½" × 48" × 87"
SRD7036	SRA7036	96½" × 48" × 99"
SRD7037	SRA7037	96½" × 48½" × 87"
SRD7038	SRA7038	96½" × 48½" × 99"

NOTE: Wood decking is not available from Rousseau.





## TIRE RACK BEAMS

SR20



- Sold in pairs
- Load capacity: 340lb. per pair
- For storing tires of different sizes up to 17" dia. (light truck and SUV)
- Designed with a sloped surface to prevent tire deformation
- 72"W beams require an SR25 tie bar installed in the center
- 15"D units recommended for tires
- 12"D units recommended for rims

PRODUCT NO.	WIDTH
SR20-36	36"
SR20-48	48"
SR20-60	60"
SR20-72	72"

## BATTERY SHELF



- Shelf includes 2 heavy-duty beams and 13 tie bars
- Includes a front stop and two side rails to prevent batteries from falling accidentally
- 15° slope for first in first out (FIFO) battery handling
- Galvanized steel

PRODUCT NO.	W × D	NO. OF BATTERIES (MEDIUM SIZE)
SRP9004	36" × 36"	15
SRP9003	36" × 48"	21
SRP9001	48" × 36"	20
SRP9002	48" × 48"	28

## HANGING RAIL

SR62



- Load capacity: 300lb. per rail
- Hooks onto Spider® posts; no bolts required
- Includes a security mechanism to prevent accidental unhooking
- Three installation positions possible: one in the middle and two closer to the edges
- Compatible with SR63-02 hooks (not included)
- The hooks can rotate once installed on the rail. They can be installed and removed at any time, even when the rail is secured in place
- Rail and adapters made of galvanized steel

SINGLE RAIL	W × D
SR62-601801	60" × 18"
SR62-602401	60" × 24"
SR62-603601	60" × 36"
SR62-721801	72" × 18"
SR62-722401	72" × 24"
SR62-723601	72" × 36"
SR62-961801	96" × 18"
SR62-962401	96" × 24"
SR62-963601	96" × 36"

DOUBLE RAIL	W × D
SR62-602402	60" × 24"
SR62-603602	60" × 36"
SR62-722402	72" × 24"
SR62-723602	72" × 36"
SR62-962402	96" × 24"
SR62-963602	96" × 36"

NOTE: When a Mini-Racking unit is joined to a back-to-back shelving unit, call Customer Service for SR62 hanging rail compatibility information.

## RAIL HOOK

SR63



- Load capacity: 50lb. per hook
- Hook can rotate once installed on a SR62 rail
- Can be installed and removed at any time, even when the rail is secured in place

PRODUCT NO.	D × H
SR63-02	2½"D × 5"H

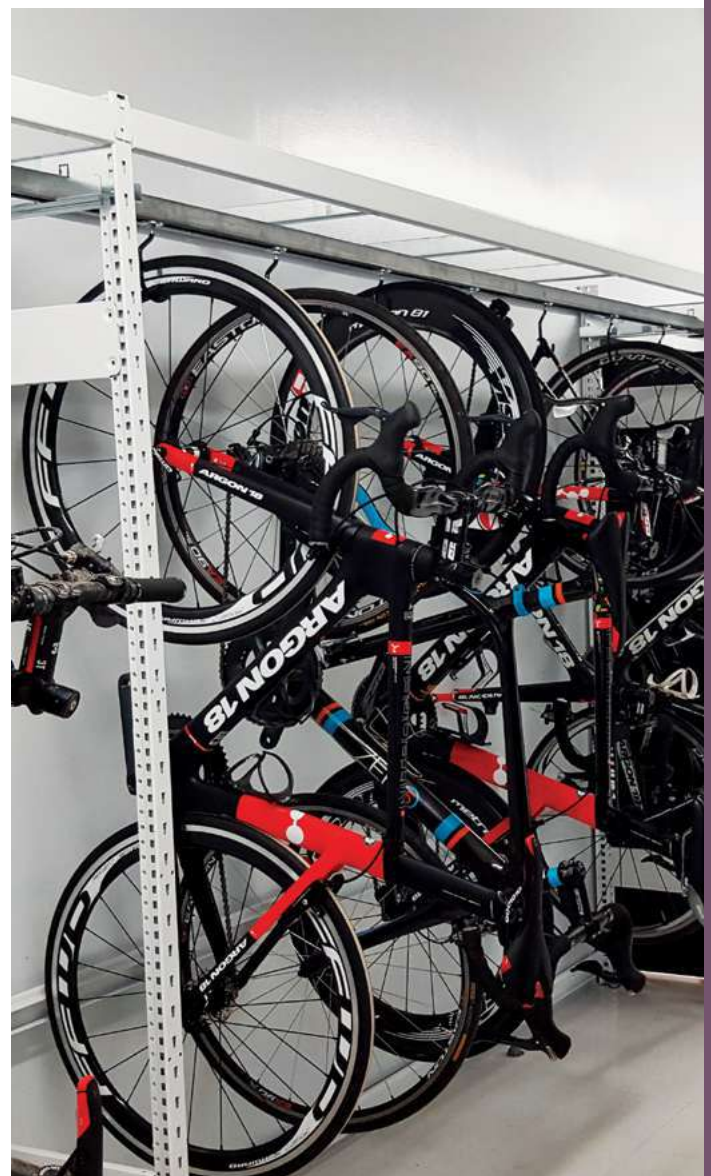

# ACCESSORIES

## LAMINATED HARDWOOD TOP FOR SHELVING SR90



- For installation between two shelving units
- Must be ordered with a pair of SH74 supports or used in a storage unit with a work surface

PRODUCT NO.	W × D
SR90-6024A	60" × 24"
SR90-7224A	72" × 24"
SR90-9624A	96" × 24"

## WOOD TOP SUPPORT SH74



- Sold in pairs
- Hooks onto the sides of SH or SR uprights; no tools required
- Supports an SR90 hardwood top between two shelving units

PRODUCT NO.	WIDTH
SH74-24	24"

## LABEL HOLDER NC32



- Sold in pairs
- Attaches to SR21 medium-duty or SR22 heavy-duty beams
- For use with self-adhesive labels only

PRODUCT NO.	WIDTH
NC32-3601	36"
NC32-4201	42"
NC32-4801	48"
NC32-6001	60"
NC32-6601	66"
NC32-7201	72"
NC32-9601	96"

## DIVIDING RODS SH56



- Sold in pairs
- ¼" dia. stainless steel rods
- Includes a 90° bend at one end to keep it in place
- Excellent chemical and corrosion resistance
- Superior rigidity to the plastic rods often found on the market for this type of application

PRODUCT NO.	HEIGHT
SH56-72	72"
SH56-84	84"
SH56-96	96"

## WALL SPACERS SR45



- Sold in pairs
- Creates a 9" space between the rack and wall
- Hooks into the delta holes of SR posts without tools; must be secured in place with a plastic clip (included)
- Galvanized steel

PRODUCT NO.	DEPTH
SR45-09	9"

## BACK-TO-BACK SPACERS SR48



- Sold in pairs
- Used for joining two Mini-Racking sections back to back with a 1" space between posts for beam adjustment

PRODUCT NO.
SR48

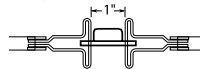

## POST SPACERS SR48



- Sold in pairs
- Creates an 18" space between two back-to-back tire racks
- Hooks into the delta holes of SR posts without tools; must be secured in place with plastic clips (included)
- Galvanized steel

PRODUCT NO.	DEPTH
SR48-18	18"

## DOUBLE DIVIDER

SR60



- Supports parts and boxes stored vertically in a Mini-Racking unit. The parts lean against the "D" of the divider
- Installs on two medium-duty (SR21) or two heavy-duty beams (SR22)
- The space between the two beams must be 14" c/c
- Divider can be adjusted laterally (left to right) without tools
- Compatible with 24"D shelving and deeper
- Designed to support a lateral load

PRODUCT NO.	D×H
SR60-2415	24"×15"



SRE4542M

## SINGLE DIVIDER

SR61



- Divides objects and parts that lean vertically against the back of a Mini-Racking unit
- Installs on medium-duty (SR21) or heavy-duty (SR22) beams
- Divider can be adjusted laterally (left to right) without tools
- Compatible with 24"D shelving and deeper

PRODUCT NO.	DEPTH
SR61-2401	24"

## SIDE UTILITY PANEL

SH68



- The Side Utility Panel can be installed on either the inside or outside of the upright
- Simple tool-free assembly
- Six widths available: 15" (12 holes), 18" (14 holes), 24" (22 holes), 30" (26 holes), 36" (32 holes) and 48" (44 holes)
- Compatible with WM9F, WM9G, WM9H, WM9J and WM9L light-duty hooks, and WM9A and WM9B heavy-duty hooks
- Compatible with WM9C rails, and WM9D, WM9M, WM9N, WM9P and WM9Q holders
- Compatible with WM21 shelves
- Load capacity: 50lb./sq. ft., 300lb. max. per panel
- To order: Complete the product number with the depth required: 15", 18", 24", 36" or 48"

PRODUCT NO.	HEIGHT
SH68-__14	14"
SH68-__20	20"
SH68-__32	32"

## FULL-HEIGHT HEAVY-DUTY UTILITY PANEL

SH69



- Heavy-duty utility panel for end-of-aisle units
- Holes spaced 1" apart c/c
- Quick and easy hook-on assembly
- Creates a neater appearance
- Five widths available: 15" (13 holes), 18" (15 holes), 24" (21 holes), 30" (27 holes) and 36" (33 holes)
- Compatible with WM9F, WM9G, WM9H, WM9J and WM9L light-duty hooks, and WM9A and WM9B heavy-duty hooks
- Compatible with WM9C rails, and WM9D, WM9M, WM9N, WM9P and WM9Q holders
- Compatible with WM21 shelves
- Load capacity: 50lb./sq. ft., 500lb. max. per panel, load evenly distributed
- Compatible with certain multi-level shelving applications. Contact Customer Service for more information
- To order: Complete the product number with the depth required: 15", 18", 24", 30" or 36"

PRODUCT NO.	HEIGHT
SH69-__51	51"
SH69-__75	75"
SH69-__87	87"

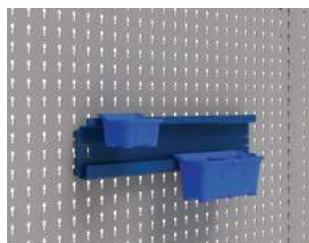
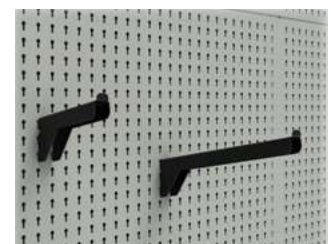
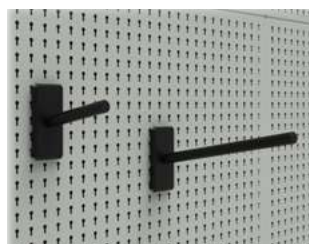

# COMPONENTS

## STRUCTURAL COMPONENTS

### POST



- Tubular T shape provides up to seven fixing zones
- Includes front holes spaced 2" apart c/c for easy adjustment of beams
- 14ga steel

PRODUCT NO.	HEIGHT
SR10-039	39"
SR10-051	51"
SR10-075	75"
SR10-087	87"
SR10-099	99"
SR10-111	111"
SR10-123	123"

SR



R5XEE-4001

### WELDED MINI-RACKING UPRIGHT ASSEMBLY



- Two heavy-duty ladder braces factory welded onto two universal posts
- Other sizes are available. Contact your customer service representative for more information

PRODUCT NO.	D × H
SR13-180752	18" × 75"
SR13-180872	18" × 87"
SR13-240752	24" × 75"
SR13-240872	24" × 87"
SR13-240992	24" × 99"
SR13-300752	30" × 75"
SR13-300872	30" × 87"
SR13-300992	30" × 99"
SR13-360752	36" × 75"
SR13-360872	36" × 87"
SR13-360992	36" × 99"
SR13-480752	48" × 75"
SR13-480872	48" × 87"
SR13-480992	48" × 99"

### MINI-RACKING LADDER BRACES

### SR30 / SR32

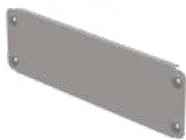

Single ladder brace for 15"D to 24"D units



Double interlocked ladder brace for 30"D to 48 1/2"D units

- Sold in pairs
- Recommendations:
  - One pair per 99"H upright and shorter
  - For uprights higher than 99"H, please contact your customer service representative
- For 30"D, 36"D, 48"D and 48 1/2"D units, the ladder braces interlock as shown
- The pair of ladder braces supplied with these models are double ladder braces

PRODUCT NO.	DEPTH
SR30-15	15"
SR30-16	16"
SR30-18	18"
SR30-24	24"
SR30-30	30"
SR30-32	32"
SR30-36	36"
SR30-48	48"
SR32-4801*	48 1/2"

NOTES: \* The SR32 ladder brace is designed to support 48"D wood panels without cutting.  
15"D, 16"D, 30"D and 32"D ladder braces are suitable for record storage, see page 260.



## BEAMS AND TIE BARS

### MEDIUM-DUTY BEAMS

SR21

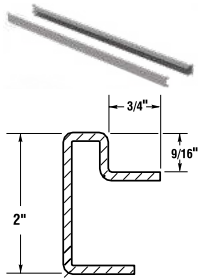

- Sold in pairs
- 14ga steel
- Install on the front of posts.
- Height can be adjusted in 2" increments c/c
- Held in place with two safety clips

PRODUCT NO.	W x H
SR21-36	36" x 2"
SR21-42	42" x 2"
SR21-48	48" x 2"
SR21-60	60" x 2"
SR21-66	66" x 2"
SR21-72	72" x 2"

NOTE: 42"W and 66"W beams are suitable for record storage, see page 260.

### HEAVY-DUTY BEAMS

SR22 / SR23

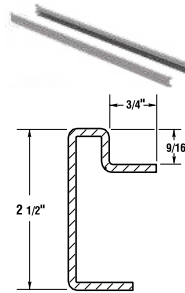

- Sold in pairs
- 12ga steel
- Install on the front of posts.
- Height can be adjusted in 2" increments c/c
- Held in place with two safety clips

PRODUCT NO.	W x H
SR22-60	60" x 2 1/2"
SR22-72	72" x 2 1/2"
SR22-96	96" x 2 1/2"
SR23-96*	96 3/4" x 2 1/2"

NOTE: \* SR23 beams can support 96"W wood panels without cutting.

### MEDIUM-DUTY TIE BAR

SR25 / SR26



- Hooks onto the inside of SR21 beams
- Galvanized steel

PRODUCT NO.	DEPTH
SR25-15	15"
SR25-16	16"
SR25-18	18"
SR25-24	24"
SR25-30	30"
SR25-32	32"
SR25-36	36"
SR25-48	48"
SR26-4801*	48 1/2"

NOTES: \* The SR26 tie bar with SR32 ladder braces is designed to support 48"D wood panels without cutting.  
15"D, 16"D, 30"D and 32"D tie bars are suitable for record storage, see page 260.

### HEAVY-DUTY TIE BAR

SR27 / SR28



- Hooks onto the inside of SR22 and SR23 beams
- Galvanized steel

PRODUCT NO.	DEPTH
SR27-15	15"
SR27-18	18"
SR27-24	24"
SR27-30	30"
SR27-32	32"
SR27-36	36"
SR27-48	48"
SR28-4801*	48 1/2"

NOTE: \* The SR28 tie bar with SR32 ladder braces is designed to support 48"D wood panels without cutting.

### BEAM LOAD CAPACITIES

Shelving load capacity tests are based on ANSI MH28.2 Shelving Manufacturer Association (SMA) standards. These load capacities include a safety factor and are valid for an evenly distributed load. The capacities specified are in pounds.

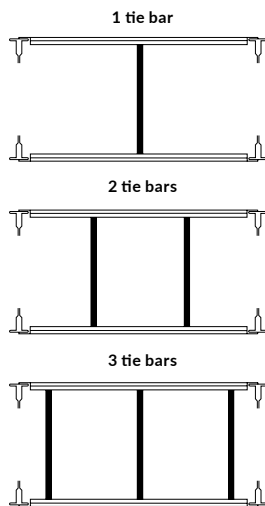

### MEDIUM-DUTY BEAMS

DECKING TYPE	DEPTH	WIDTH						NO. OF TIE BARS
		36"	42"	48"	60"	66"	72"	
Wood*	15" to 24"	1000	1000	975	800	725	650	1
	30" to 32"	1075	1025	925	775	700	625	2
	36"	850	875	900	750	700	625	2
	48"	875	825	775	775	750	650	3
Steel*	15" to 24"	900	900	900	800	750	650	1
	30" to 48"	1125	1125	1000	800	750	650	1
Wire Mesh	24" to 48"	600	700	800	800	750	650	1

### HEAVY-DUTY BEAMS

DECKING TYPE	DEPTH	WIDTH			NO. OF TIE BARS
		60"	72"	96"	
Wood*	15" to 24"	1650	1600	1225	2
	30" to 32"	1850	1575	1225	2
	36"	1750	1600	1225	3
	48"	1225	1225	1225	3
Steel*	15" to 24"	1350	1350	1225	1
	30" to 48"	1925	1600	1225**	1
Wire Mesh	24" to 48"	1000	1200	1200**	1

\*\* 96"W x 48"D steel or wire mesh decking require two tie bars.

# COMPONENTS

## MINI-RACKING DECKING

### STEEL DECKING

SR40 / SH20

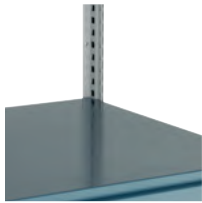

- SH20: Formed with a quadruple bend at the front and back and a single bend on the sides
- SR40: Formed with a triple bend on the sides and single bend at the front and back
- Steel decking provides extra shelf rigidity

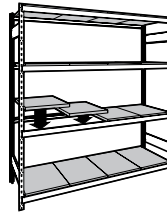

To order for your specific unit dimensions, order the appropriate number of shelves and the product number(s) specified in the chart for each level of shelving.

FOR A STANDALONE MINI-RACKING UNIT OR TWO JOINED TOGETHER

Mini-Racking units in these sizes can be standalone or joined to another Mini-Racking unit.



UPRIGHT ASSEMBLY DEPTH	BEAM WIDTH													
	36"		42"		48"		60"		66"		72"		96"	
	QTY	PRODUCT NO.	QTY	PRODUCT NO.	QTY	PRODUCT NO.	QTY	PRODUCT NO.	QTY	PRODUCT NO.	QTY	PRODUCT NO.	QTY	PRODUCT NO.
15"	2	SR40-1815	1+	SR40-1815	2	SR40-2415	2+	SR40-1815	1+	SR40-1815	3	SR40-2415	4	SR40-2415
			1	SR40-2415			1	SR40-2415	2	SR40-2415				
16"	2	SR40-1816	1+	SR40-1816	2	SR40-2416	2+	SR40-1816	1+	SR40-1816	3	SR40-2416	4	SR40-2416
			1	SR40-2416			1	SR40-2416	2	SR40-2416				
18"	2	SR40-1818	1+	SR40-1818	2	SR40-2418	2+	SR40-1818	1+	SR40-1818	3	SR40-2418	4	SR40-2418
			1	SR40-2418			1	SR40-2418	2	SR40-2418				
24"	2	SR40-1824	1+	SR40-1824	2	SR40-2424	2+	SR40-1824	1+	SR40-1824	3	SR40-2424	4	SR40-2424
			1	SR40-2424			1	SR40-2424	2	SR40-2424				
30"	2	SH20-3018	1+	SH20-3018	4	SH20-3012	4	SH20-3015	1+	SH20-3018	4	SH20-3018	4	SH20-3024
			1	SH20-3024					2	SH20-3024				
32"	2	SR40-1832	1+	SR40-1832	2	SR40-2432	2+	SR40-1832	1+	SR40-1832	3	SR40-2432	4	SR40-2432
			1	SR40-2432			1	SR40-2432	2	SR40-2432				
36"	2	SH20-3618	1+	SH20-3618	4	SH20-3612	4	SH20-3615	1+	SH20-3618	4	SH20-3618	4	SH20-3624
			1	SH20-3624					2	SH20-3624				
48"	2	SH20-4818	1+	SH20-4818	4	SH20-4812	4	SH20-4815	1+	SH20-4818	4	SH20-4818	4	SH20-4824
			1	SH20-4824					2	SH20-4824				

FOR A MINI-RACKING UNIT JOINED TO TWO SHELVING UNITS

Mini-Racking units in these sizes can be joined to back-to-back shelving units of the same depth.

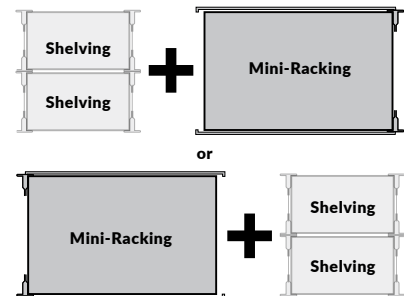

UPRIGHT ASSEMBLY DEPTH	BEAM WIDTH					
	60"		72"		96"	
	QTY	PRODUCT NO.	QTY	PRODUCT NO.	QTY	PRODUCT NO.
30"	5	SH20-3012	1+	SH20-3012	1+	SH20-3024
			4	SH20-3015	4	SH20-3018
36"	5	SH20-3612	1+	SH20-3612	1+	SH20-3624
			4	SH20-3615	4	SH20-3618
48"	5	SH20-4812	1+	SH20-4812	1+	SH20-4824
			4	SH20-4815	4	SH20-4818

FOR A MINI-RACKING UNIT JOINED TO FOUR SHELVING UNITS

Mini-Racking units in these sizes can be joined to two back-to-back shelving units of the same depth, one on each side of the Mini-Racking unit.



UPRIGHT ASSEMBLY DEPTH	BEAM WIDTH			
	72"		96"	
	QTY	PRODUCT NO.	QTY	PRODUCT NO.
30"	6	SH20-3012	2+	SH20-3012
			4	SH20-3018
36"	6	SH20-3612	2+	SH20-3612
			4	SH20-3618
48"	6	SH20-4812	2+	SH20-4812
			4	SH20-4818

SR42

## WIRE MESH DECKING

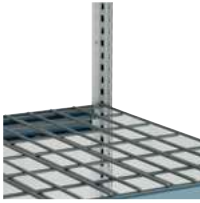

- Grid-pattern shelves made from 1/4" dia. painted steel rods welded together
- Color: Modern Gray 745
- Product meets fire code standards
- Wire mesh decking is a great alternative to steel decking



To order for your specific unit dimensions, order the appropriate number of shelves and the product number(s) specified in the chart for each level of shelving.

FOR A STANDALONE MINI-RACKING UNIT OR TWO JOINED TOGETHER



FOR A MINI-RACKING UNIT JOINED TO TWO SHELVING UNITS

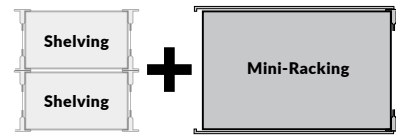

FOR A MINI-RACKING UNIT JOINED TO FOUR SHELVING UNITS



UPRIGHT ASSEMBLY DEPTH	BEAM WIDTH													
	36"		42"		48"		60"		66"		72"		96"	
	QTY	PRODUCT NO.	QTY	PRODUCT NO.	QTY	PRODUCT NO.	QTY	PRODUCT NO.	QTY	PRODUCT NO.	QTY	PRODUCT NO.	QTY	PRODUCT NO.
24"	2	SR42-1824	1+ 1	SR42-1824 SR42-2424	2	SR42-2424	2+ 1	SR42-1824 SR42-2424	1+ 2	SR42-1824 SR42-2424	3	SR42-2424	4	SR42-2424
30"	2	SR42-1830	1+ 1	SR42-1830 SR42-2430	2	SR42-2430	2+ 1	SR42-1830 SR42-2430	1+ 2	SR42-1830 SR42-2430	3	SR42-2430	4	SR42-2430
36"	2	SR42-1836	1+ 1	SR42-1836 SR42-2436	2	SR42-2436	2+ 1	SR42-1836 SR42-2436	1+ 2	SR42-1836 SR42-2436	3	SR42-2436	4	SR42-2436
48"	2	SR42-1848	1+ 1	SR42-1848 SR42-2448	2	SR42-2448	2+ 1	SR42-1848 SR42-2448	1+ 2	SR42-1848 SR42-2448	3	SR42-2448	4	SR42-2448

## WOOD DECKING DIMENSIONS

- 30"D, 36"D and 48"D Mini-Racking units can be joined to two back-to-back shelving units (except 96 1/2"W). Please see technical guide S52 for exact wood decking dimensions for your specific installation.

### IMPORTANT

Wood decking is not available from Rousseau.  
Our beams are designed to support plywood or particle board panels at least 5/8" thick.

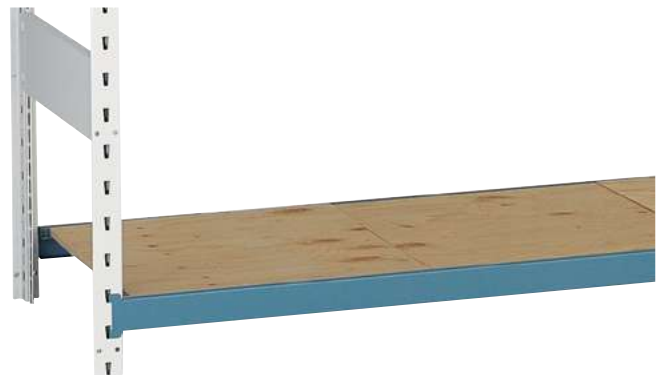



INDEX	PAGE(S)
Mobile Shelving and Mini-Racking	126
Preconfigured Models . . .	127-128
Components . . . . .	129

## MOBILE SHELVING AND MINI-RACKING

Mobile storage allows you to complete your tasks quickly and effectively while keeping equipment close at hand.

Our heavy-duty base has been specially designed so you can easily and safely move a load of up to 1,000lb. per unit!

By adding a mobile base to your shelving or Mini-Racking, you can:

- Clear the floor area to facilitate cleaning under shelving
- Quickly reconfigure your department
- Move parts closer to workstations

You can also add accessories, such as handles to help with moving units, or protective plastic bumpers to prevent damage from impacts.



SRE4006M



SRE4522SM





SRE4003M

**WHEN ORDERING, MODEL NUMBERS MUST BE COMPLETED AS FOLLOWS**

H for posts with a smooth surface  
R for posts with a perforated surface

BOLTED uprights     D  
WELDED uprights    E

S

}

4001M

e.g., SHD4001  
For a mobile shelving unit with smooth surface posts and bolted uprights.

## MOBILE SHELVING

HERE ARE SOME OF OUR MOST POPULAR PRECONFIGURED MODELS OF MOBILE SPIDER® SHELVING UNITS

- The preconfigured models in this section include a mobile base for Spider® Shelving and four 4" casters, including two swivel casters with total-lock brakes and two rigid casters
- To calculate the actual width of the base, add 3<sup>3</sup>/<sub>16</sub>" to the nominal width
- To calculate the actual depth of the base, add 3<sup>4</sup>/<sub>4</sub>" to the nominal depth
- The preconfigured models in this section include open shelving uprights, braces and BOX shelves
- Load capacity: 1,000lb. per base
- All preconfigured models are quick and easy to assemble and can be disassembled when not in use

W	DIMENSIONS			NUMBER OF SHELVES
	D	H	ACTUAL H	6
36"	18"	63"	68 1/4"	S_ _4001M
	24"	63"	68 1/4"	S_ _4002M
		75"	80 1/4"	S_ _4003M
42"	18"	63"	68 1/4"	S_ _4004M
	24"	63"	68 1/4"	S_ _4005M
		75"	80 1/4"	S_ _4006M
48"	18"	63"	68 1/4"	S_ _4007M
	24"	63"	68 1/4"	S_ _4008M
		75"	80 1/4"	S_ _4009M

NOTES: For a side-to-side double shelving unit, see SH99 Mobile Base for Mini-Racking, see page 129.  
Not compatible with drawers or roll-out shelves in shelving and SH41, SH43, SH91 and SH93 doors.



SRD9002M



SRE4010M

# PRECONFIGURED MODELS – MOBILE MINI-RACKING

## MOBILE MINI-RACKING

HERE ARE SOME OF OUR MOST POPULAR PRECONFIGURED MODELS OF MOBILE MINI-RACKING UNITS

- Can be ordered with steel decking, wire mesh decking or without decking
- The preconfigured models in this section include a mobile base for Mini-Racking and four 4" casters, including two swivel casters with total-lock brakes and two rigid casters
- Models with a 30"D base or deeper include a mobile Mini-Racking handle
- 36"W to 72"W models include medium duty-beams, whereas 96"W models include heavy-duty beams
- To calculate the actual width of the base, add 3 3/4" to the nominal width
- To calculate the actual depth of the base, add 3/4" to the nominal depth
- Load capacity: 1,000lb. per base
- All preconfigured models are quick and easy to assemble and can be disassembled when not in use

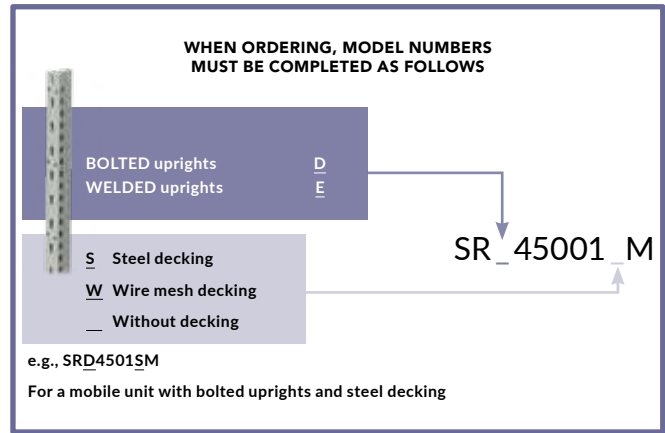

### STEEL

- To order a unit with steel decking, add S to the product number

### WIRE MESH

- To order a unit with wire mesh decking, add W to the product number
- Not compatible with 18"D units

W	DIMENSIONS			NO. OF DECKING LEVELS
	D	H	ACTUAL H	4
36"	18"	63"	68 1/4"	SR_4501_M
	24"	63"	68 1/4"	SR_4502_M
		75"	80 1/4"	SR_4503_M
42"	18"	63"	68 1/4"	SR_4504_M
	24"	63"	68 1/4"	SR_4505_M
		75"	80 1/4"	SR_4506_M
48"	18"	63"	68 1/4"	SR_4507_M
	24"	63"	68 1/4"	SR_4508_M
		75"	80 1/4"	SR_4509_M
60"	24"	63"	68 1/4"	SR_4510_M
		75"	80 1/4"	SR_4511_M
	30"	63"	68 1/4"	SR_4512_M
		75"	80 1/4"	SR_4513_M
	36"	63"	68 1/4"	SR_4514_M
		75"	80 1/4"	SR_4515_M
66"	48"	63"	68 1/4"	SR_4516_M
		75"	80 1/4"	SR_4517_M
	24"	63"	68 1/4"	SR_4518_M
		75"	80 1/4"	SR_4519_M
	30"	63"	68 1/4"	SR_4520_M
		75"	80 1/4"	SR_4521_M
36"	63"	68 1/4"	SR_4522_M	
	75"	80 1/4"	SR_4523_M	
48"	63"	68 1/4"	SR_4524_M	
	75"	80 1/4"	SR_4525_M	

### FOR WOOD DECKING

- To order a unit without decking (e.g., for use with wood decking), leave the product number as is

W	DIMENSIONS			NO. OF DECKING LEVELS
	D	H	ACTUAL H	4
72"	24"	63"	68 1/4"	SR_4526_M
		75"	80 1/4"	SR_4527_M
	30"	63"	68 1/4"	SR_4528_M
		75"	80 1/4"	SR_4529_M
	36"	63"	68 1/4"	SR_4530_M
		75"	80 1/4"	SR_4531_M
48"	63"	68 1/4"	SR_4532_M	
	75"	80 1/4"	SR_4533_M	
	24"	63"	68 1/4"	SR_4534_M
		75"	80 1/4"	SR_4535_M
96"	30"	63"	68 1/4"	SR_4536_M
		75"	80 1/4"	SR_4537_M
	36"	63"	68 1/4"	SR_4538_M
		75"	80 1/4"	SR_4539_M
	48"	63"	68 1/4"	SR_4540_M
		75"	80 1/4"	SR_4541_M



NOTE: Handles are not included with 18"D and 24"D models.

## MOBILITY

### MOBILE BASE FOR SPIDER® SHELVING SH99



- Required for installing casters under a Rousseau Spider® Shelving unit
- Compatible with 4" and 6" casters (sold separately)
- The shelving unit must have exactly the same dimensions as the base
- For a side-to-side double shelving unit, see SH99 Mobile Base for Mini-Racking
- Compatible with 18"D and 24"D, and 36"W, 42"W and 48"W shelving
- The 18"D base is compatible with 63"H shelving and under
- The 24"D base is compatible with 75"H shelving and under
- Load capacity: 1,000lb. per base
- To order: Complete the product number with the depth required: 18" or 24"

**!**  
Does not include casters, handles or bumpers. They must be ordered separately.

PRODUCT NO.	WIDTH	ACTUAL WIDTH
SH99-36__	36"	39 <sup>3</sup> / <sub>16</sub> "
SH99-42__	42"	45 <sup>3</sup> / <sub>16</sub> "
SH99-48__	48"	51 <sup>3</sup> / <sub>16</sub> "

NOTES: With SB81 casters, total height = 5<sup>1</sup>/<sub>4</sub>"; With SB84 casters, total height = 7<sup>3</sup>/<sub>16</sub>".  
Not compatible with back-to-back shelving configurations.  
Not compatible with drawers or roll-out shelves in shelving and SH41, SH43, SH91 and SH93 doors.

### MOBILE BASE FOR MINI-RACKING SH99



- Required for installing casters under a Rousseau Mini-Racking unit
- Compatible with 4" and 6" casters (sold separately)
- Compatible with 24"D, 30"D, 36"D and 48"D; 48"W, 60"W, 66"W, 72"W and 96"W; and 63"H and 75"H Mini-Racking
- Can support a side-by-side double shelving unit or Mini-Racking unit depending on the mobile base width:
  - 48"W (not compatible)
  - 60"W (30"W unit + 30"W unit)
  - 66"W (not compatible)
  - 72"W (36"W unit + 36"W unit)
  - 96"W (48"W unit + 48"W unit)
- With double shelving or Mini-Racking units, order an extra pair of rigid casters for the middle (under the adjoining posts)
- Load capacity: 1,000lb. per base
- To order: Complete the product number with the depth required: 24", 30", 36" or 48"

**!**  
Does not include casters, handles or bumpers. They must be ordered separately.

PRODUCT NO.	WIDTH	ACTUAL WIDTH
SH99-48__	48"	51 <sup>3</sup> / <sub>16</sub> "
SH99-60__	60"	63 <sup>3</sup> / <sub>16</sub> "
SH99-66__	66"	69 <sup>3</sup> / <sub>16</sub> "
SH99-72__	72"	75 <sup>3</sup> / <sub>16</sub> "
SH99-96__	96"	99 <sup>3</sup> / <sub>16</sub> "

NOTES: With SB81 casters, total height = 5<sup>1</sup>/<sub>4</sub>"; With SB84 casters, total height = 7<sup>3</sup>/<sub>16</sub>".  
Not compatible with back-to-back shelving configurations.

### 4" CASTERS SB81



- Sold in pairs
- Three types of casters available: rigid, swivel and swivel with total-lock brake (on wheel and swivel)
- Load capacity: 440lb. per caster
- Total height: 5<sup>1</sup>/<sub>8</sub>"
- Dark gray, non-marking polyurethane tread. Superior industrial quality
- Installs under a mobile base for shelving or Mini-Racking, one caster under each post

PRODUCT NO.	CASTER TYPE
SB81-01	Rigid
SB81-02	Swivel
SB81-03	Swivel with total-lock brake

### 6" CASTERS SB84



- Sold in pairs
- Three types of casters available: rigid, swivel and swivel with total-lock brake (on wheel and swivel)
- Load capacity: 1100lb. per caster
- Total height: 7<sup>1</sup>/<sub>2</sub>"
- Dark gray, ultra-quiet polyurethane tread. Superior industrial quality
- Installs under a mobile base for shelving or Mini-Racking, one caster under each post

PRODUCT NO.	CASTER TYPE
SB84-01	Rigid
SB84-02	Swivel
SB84-03	Swivel with total-lock brake

### HANDLES FOR MOBILE SHELVING AND MINI-RACKING SH97



- Recommended for shelving or Mini-Racking units 30"D or deeper
- The handles install on the sides of the shelving or Mini-Racking units and must be installed horizontally
- To order: Complete the product number with the depth required: 18", 24", 30", 36" or 48"

PRODUCT NO.
SH97__01

### BUMPERS FOR MOBILE SHELVING AND MINI-RACKING SH98



- Sold in kits of four
- Made of high-density plastic
- Color: gray
- Installs on all four corners of the base for protection from impacts

PRODUCT NO.
SH98-01



INDEX	PAGE(S)
Drawers for Shelving	130-131
Preconfigured Models . . .	132-133
Components . . . . .	134-135
Accessories . . . . .	136
Assembly and Security Recommendations . . .	137

## MAXIMIZE USE OF SPACE

Say goodbye to poorly lit shelves, backaches and difficulty accessing materials caused by inadequate storage! Let us help you redesign your space.

As storage specialists, we recommend adding Rousseau drawers to your shelving units to maximize their potential. You will gain a hybrid and versatile system that has proved its effectiveness for over 30 years.

With their sturdy construction and distinctive design, Rousseau drawers add value to your existing equipment. Rousseau's modular drawers can be installed in over 35 brands of shelving on the market, so you can even keep your existing set-up. What's more, your new storage system can scale up or down in line with the needs of your business. A simple and economic solution; just imagine the possibilities!

## THE ROUSSEAU DIFFERENCE

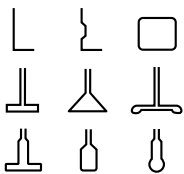

The drawers can also be installed in over 35 brands of shelving available on the market. Quick and easy hook-on assembly in most brands of shelving.

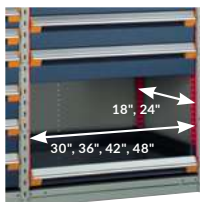

A range of dimensions available: 30"W, 36"W, 42"W and 48"W by 18"D and 24"D. Only one set of brackets required for all dimensions.



10 drawer heights and 7 drawer side heights available.



Quick and easy installation:  
 1. Hook brackets on  
 2. Hook rails on  
 3. Insert carriages and drawers



400lb. load capacity per drawer. Most durable drawer in the industry.

## GENERAL DIMENSIONS

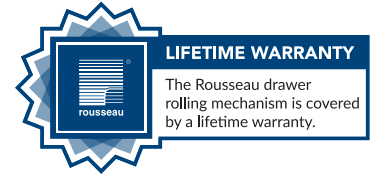

NOTE: Popular dimensions are shown in red.

## RECLAIM EXISTING SPACE

Instead of building an addition, use high-density storage and optimize the investment you made in your original space.

Ask our expert consultants for a comprehensive analysis of your potential savings.

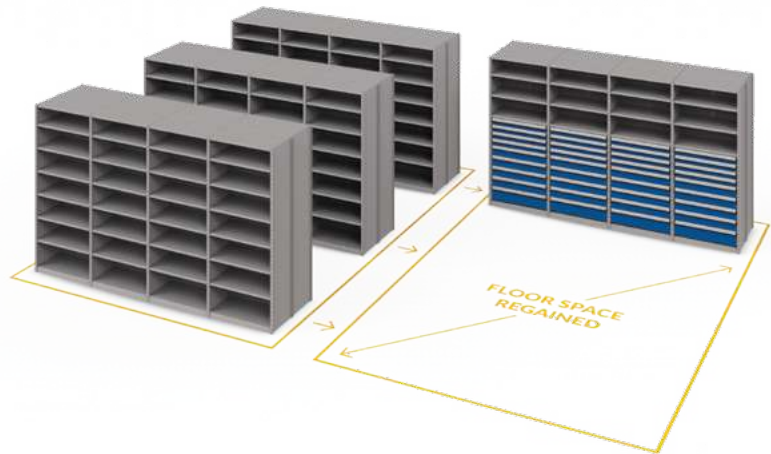
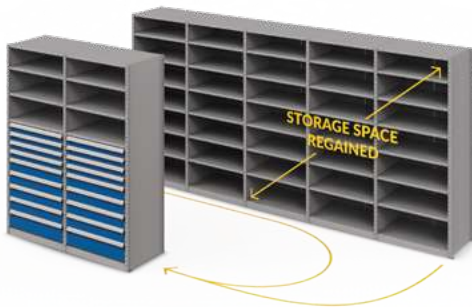

### CURRENT SITUATION

- 1 Top and bottom shelves are not properly filled, nor accessible.
- 2 Back of shelves are poorly lit and visible.
- 3 Visibility of various items is hampered by the shelves.
- 4 Vast amount of unused space between shelves.

### RESULT

Arduous management and location of your inventory.

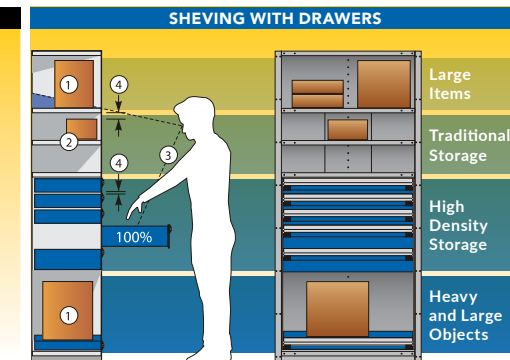
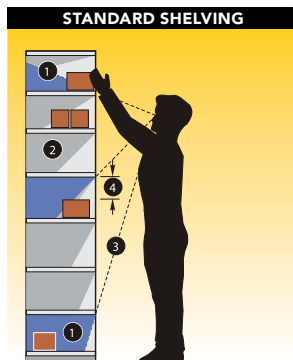

### OUR RECOMMENDATIONS

- 1 Widely spaced shelves for the storage of larger items.
- 2 Close-set shelves positioned at eye-level.
- 3 Easily locate objects in a drawer that opens at 100%.
- 4 Optimized use of space based on the sizes of its stored items.

### RESULT

Easier management of your inventory based on an organized storage method.

# PRECONFIGURED MODELS

HERE ARE SOME OF OUR MOST POPULAR PRECONFIGURED MODELS OF MODULAR DRAWERS FOR SHELVING

- Rousseau modular drawers can be installed in over 35 brands of commercially available shelving
- The preconfigured models in this section include brackets for Rousseau Spider® Shelving. For other types of shelving, please specify the brand and shelving type when ordering, see [page 135](#).

## IMPORTANT

Drawer compartments are included in all models.

To order drawers without compartments, replace the last two digits of the model number with the next even number up.

e.g., R5LEC-1801 with  
R5LEC-1802 without

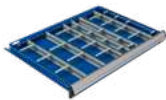

Shelving with drawers must be anchored to the floor.



R5SEE-874811

DRAWER DIMENSIONS	NUMBER OF COMPARTMENTS (LAYOUT CODE)					
	36" W × 18" D	36" W × 24" D	42" W × 18" D	42" W × 24" D	48" W × 18" D	48" W × 24" D
3"H to 5"H	24 (0518)	30 (0524)	20 (0512)	30 (0524)	32 (0724)	40 (0732)
6"H to 8"H	8 (0304)	12 (0308)	12 (0308)	12 (0308)	10 (0405)	15 (0410)
9"H and higher	6 (0203)	9 (0206)	6 (0203)	8 (0304)	8 (0304)	8 (0304)

NOTE: For interior drawer dimensions, see [pages 220-222](#).

Shelving units must be ordered separately, see [pages 101-104](#).

## 18"H BANK OF DRAWERS FOR SHELVING



R5LEE-1801

- 4 drawers :
  - 3 drawers, 4"H
  - 1 drawer, 6"H

PRODUCT NO.	W × D
R5LEC-1801	36" × 18"
R5LEE-1801	36" × 24"
R5LGC-1801	42" × 18"
R5LGE-1801	42" × 24"
R5LHC-1801	48" × 18"
R5LHE-1801	48" × 24"

NOTE: Shelving units must be ordered separately.

## 24"H BANK OF DRAWERS FOR SHELVING



R5LEE-2401

- 5 drawers :
  - 3 drawers, 4"H
  - 2 drawers, 6"H

PRODUCT NO.	W × D
R5LEC-2401	36" × 18"
R5LEE-2401	36" × 24"
R5LGC-2401	42" × 18"
R5LGE-2401	42" × 24"
R5LHC-2401	48" × 18"
R5LHE-2401	48" × 24"

NOTE: Shelving units must be ordered separately.

## 36"H BANK OF DRAWERS FOR SHELVING



R5LEE-3601

- 7 drawers :
  - 3 drawers, 4"H
  - 4 drawers, 6"H

PRODUCT NO.	W × D
R5LEC-3601	36" × 18"
R5LEE-3601	36" × 24"
R5LGC-3601	42" × 18"
R5LGE-3601	42" × 24"
R5LHC-3601	48" × 18"
R5LHE-3601	48" × 24"

NOTE: Shelving units must be ordered separately.



R5LEE-3603

- 7 drawers :
  - 4 drawers, 4"H
  - 2 drawers, 6"H
  - 1 drawer, 8"H

PRODUCT NO.	W × D
R5LEC-3603	36" × 18"
R5LEE-3603	36" × 24"
R5LGC-3603	42" × 18"
R5LGE-3603	42" × 24"
R5LHC-3603	48" × 18"
R5LHE-3603	48" × 24"

NOTE: Shelving units must be ordered separately.

## 48" H BANK OF DRAWERS FOR SHELVING



R5LEE-4801

- 8 drawers :
  - 8 drawers, 6"H

PRODUCT NO.	W x D
R5LEC-4801	36" x 18"
R5LEE-4801	36" x 24"
R5LGC-4801	42" x 18"
R5LGE-4801	42" x 24"
R5LHC-4801	48" x 18"
R5LHE-4801	48" x 24"

NOTE: Shelving units must be ordered separately.



R5LEE-4803

- 9 drawers :
  - 4 drawers, 4"H
  - 4 drawers, 6"H
  - 1 drawer, 8"H

PRODUCT NO.	W x D
R5LEC-4803	36" x 18"
R5LEE-4803	36" x 24"
R5LGC-4803	42" x 18"
R5LGE-4803	42" x 24"
R5LHC-4803	48" x 18"
R5LHE-4803	48" x 24"

NOTE: Shelving units must be ordered separately.



R5LEE-4805

- 10 drawers :
  - 6 drawers, 4"H
  - 4 drawers, 6"H

PRODUCT NO.	W x D
R5LEC-4805	36" x 18"
R5LEE-4805	36" x 24"
R5LGC-4805	42" x 18"
R5LGE-4805	42" x 24"
R5LHC-4805	48" x 18"
R5LHE-4805	48" x 24"

NOTE: Shelving units must be ordered separately.



R5LEE-4807

- 11 drawers :
  - 4 drawers, 3"H
  - 3 drawers, 4"H
  - 4 drawers, 6"H

PRODUCT NO.	W x D
R5LEC-4807	36" x 18"
R5LEE-4807	36" x 24"
R5LGC-4807	42" x 18"
R5LGE-4807	42" x 24"
R5LHC-4807	48" x 18"
R5LHE-4807	48" x 24"

NOTE: Shelving units must be ordered separately.



R5LEE-4809

- 7 drawers :
  - 2 drawers, 3"H
  - 3 drawers, 4"H
  - 2 drawers, 6"H
- 1 front access roll-out shelf

PRODUCT NO.	W x D
R5LEC-4809	36" x 18"
R5LEE-4809	36" x 24"
R5LGC-4809	42" x 18"
R5LGE-4809	42" x 24"
R5LHC-4809	48" x 18"
R5LHE-4809	48" x 24"

NOTE: Shelving units must be ordered separately.



## DRAWERS, SHELVES AND LOCKING/SECURITY MECHANISMS

### HEAVY-DUTY MODULAR DRAWER



- Painted steel drawer: RF32
- Drawer with stainless steel front and gray painted steel interior: RF36
- 400lb. load capacity, 100% extension
- Heavy-duty construction
- Easy to install
- Vast choice of accessories available to customize the drawer to your storage needs, [see pages 242-247](#);
- Drawer heights available: 3", 4", 5", 6", 7", 8", 9", 10", 12" and 14"
- For preconfigured modular drawer compartment layouts, [see pages 224-241](#);
- To order: Add the drawer height to the product number and specify the type of drawer front required (painted steel or stainless steel), e.g., RF32-362406

PRODUCT NO.	W x D
RF__-3018__	30" x 18"
RF__-3024__	30" x 24"
RF__-3618__	36" x 18"
RF__-3624__	36" x 24"
RF__-4218__	42" x 18"
RF__-4224__	42" x 24"
RF__-4818__	48" x 18"
RF__-4824__	48" x 24"

### HEAVY-DUTY 3-SIDED-ACCESS ROLL-OUT SHELF



- 400lb. load capacity, 100% extension
- Heavy-duty construction
- Easy to install
- Galvanized steel with 1½"H back edge
- Total height: 5"
- Can be used as a work surface

PRODUCT NO.	W x D
RF45-3018	30" x 18"
RF45-3024	30" x 24"
RF45-3618	36" x 18"
RF45-3624	36" x 24"
RF45-4218	42" x 18"
RF45-4224	42" x 24"
RF45-4818	48" x 18"
RF45-4824	48" x 24"

### DRAWER LOCK

L3



- Compatible with all drawer dimensions
- Does not reduce the drawer's storage space
- Easy to retrofit
- To order: Add L3 to the product number for the drawer or preconfigured compartment layout, e.g., RF32-362406L3
- For replacement parts or to retrofit this mechanism, order an RY01-L3



PRODUCT NO.
L3

### HEAVY-DUTY FRONT-ACCESS ROLL-OUT SHELF



- 400lb. load capacity, 100% extension
- Heavy-duty construction
- Easy to install
- Painted steel with 3"H edges on the sides and back
- Total height: 6"
- Full access to contents

PRODUCT NO.	W x D
RF41-3018	30" x 18"
RF41-3024	30" x 24"
RF41-3618	36" x 18"
RF41-3624	36" x 24"
RF41-4218	42" x 18"
RF41-4224	42" x 24"
RF41-4818	48" x 18"
RF41-4824	48" x 24"

### LOCK-OUT MECHANISM

RF85

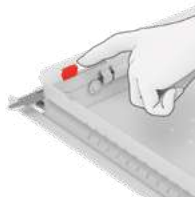

- For both drawers and roll-out shelves
- Locks drawers and roll-out shelves in an open position
- Activated manually, only when required
- Compatible with all drawer accessories
- Plastic bins in the back row may make it more difficult to activate the mechanism

PRODUCT NO.
RF85

### SECURITY PANEL

RF91



- Compatible with drawer locks
- Blocks access between two drawers or two banks of drawers
- Usable space in the bank of drawers is reduced by 1"
- Installs between two drawers

PRODUCT NO.	W x D
RF91-3018	30" x 18"
RF91-3024	30" x 24"
RF91-3618	36" x 18"
RF91-3624	36" x 24"
RF91-4218	42" x 18"
RF91-4224	42" x 24"
RF91-4818	48" x 18"
RF91-4824	48" x 24"



RE00

MOUNTING BRACKETS

STANDARD MOUNTING BRACKETS



Rousseau modular drawers can be installed in over 35 brands of commercially available shelving.

- Quick and easy hook-on assembly in most brands of shelving
- Standard heights available: 18", 24", 36" and 48"
- Mounting bracket kits are compatible with all Rousseau drawer widths (30", 36", 42" and 48")
- Each kit includes two front and two rear mounting brackets and all hardware required
- Includes holes spaced 1" apart c/c for easy adjustment of shelves
- Two brackets can be stacked if a shelf is installed between them.
- The total height of the drawers must not exceed 60", e.g., 36"H + 18"H = 54"H (safe height), [see page 137](#)
- To order non-standard mounting bracket heights, please contact Customer Service
- To order: Complete the product number with the shelving brand code required, e.g., RE30-48 for Rousseau Spider® shelving

PRODUCT NO.	HEIGHT
RE__-18	18"
RE__-24	24"
RE__-36	36"
RE__-48	48"

SHELVING BRAND CODES

COMPANY	BRAND	CODE
Aurora	Quik-Lok	RE04
Bilt Industries	Klip-Bilt II	RE18
Borroughs	Steel Shelving	RE02
Easyup	7000	RE31
Equipto	V-Grip	RE29
EZ Rect	Trim Line	RE26
EZ Rect	Type I	RE14
Hallowell	Hi-Tech Shelving	RE07
Inca	Inca-matic	RE10
Lyon	8000	RE16
Metalware	Interlok	RE05
Penco	Clipper	RE08
Penco	Erectomatic	RE07
Republic	Clip Shelving	RE20
Rousseau	«O»	RE01
<b>Rousseau</b>	<b>Spider®</b>	<b>RE30</b>
Spacesaver	4-post Shelving	RE04
Tennsco	L&T Shelving	RE04
Tennsco	Q-Line	RE43
Tri-Boro	Steel Shelving	RE33
Triple A	600	RE27
Western Pacific	Clip Shelving	RE22
Western Pacific	Deluxe	RE24

EXAMPLES OF COMPATIBLE UPRIGHTS

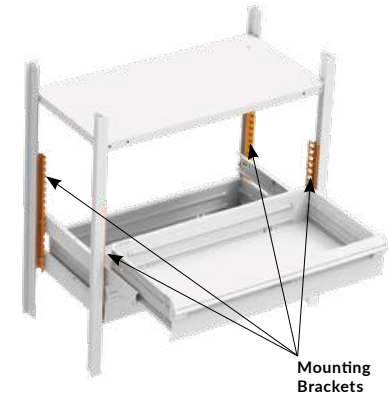
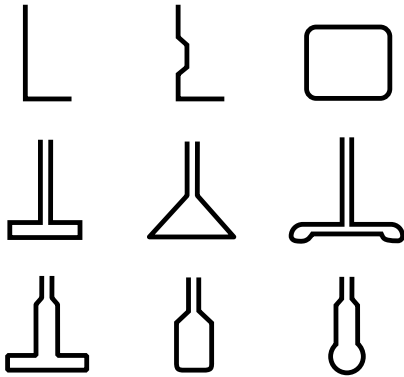

NOTES: Other mounting brackets are available. If your brand of shelving is not listed here, please contact Customer Service.  
The brands listed are the property of their respective owners.

CUSTOM-ORDER MOUNTING BRACKETS

Rousseau can manufacture mounting brackets for new shelving upon request.  
Please contact Customer Service for more information.



## ACCESSORIES

## VERTICAL SECURITY BAR

RE80



- Locks all drawers in a shelving unit with a key or padlock
- The key or safety hasp is located at the top of the bar to facilitate access
- Covers a bank of drawers from 18"H to 48"H
- Quick and easy hook-on assembly
- More than one bar on the same mounting bracket can be installed (for different users)
- Installs on the right-hand side
- The 36"H bar is compatible with the 34"H mounting bracket, and the 48"H bar is compatible with the 46"H mounting bracket
- Compatible with Rousseau Spider® shelving only. For Spacesaver shelving, order RE81-HHL3A instead of RE80-HHL3A
- To order: Specify the type of lock required, for a safety hasp, add LP to the product number; for a standard lock, add L3 to the product number



PRODUCT NO.	HEIGHT
RE80-18__A	18"
RE80-24__A	24"
RE80-30__A	30"
RE80-36__A	36"
RE80-48__A	48"

## FILLER

RE90



- Installs under the bank of drawers with an adhesive strip
- Fulfills aesthetic requirements of certain work environments (hospitals, offices, etc.)
- Compatible with Rousseau Spider® and Spacesaver shelving only
- For Spacesaver shelving, order RE90-WW02 instead of RE90-WW01

PRODUCT NO.	W x H
RE90-3001	30" x 5/8"
RE90-3601	36" x 5/8"
RE90-4201	42" x 5/8"
RE90-4801	48" x 5/8"

NOTES: Other accessories for Spider® shelving are available in the Spider® Shelving System section, [see pages 93-100](#).

To lock drawers in all other brands of shelving, use the L3 Drawer Lock, [see page 134](#).

## REAL-WORLD EXAMPLES

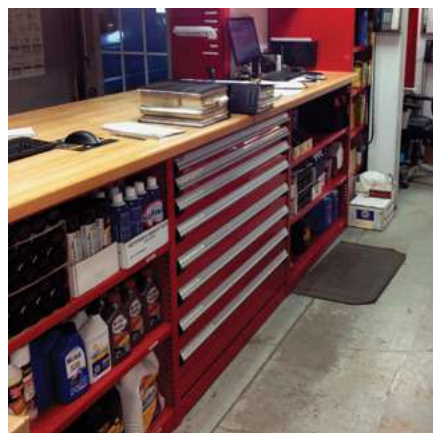
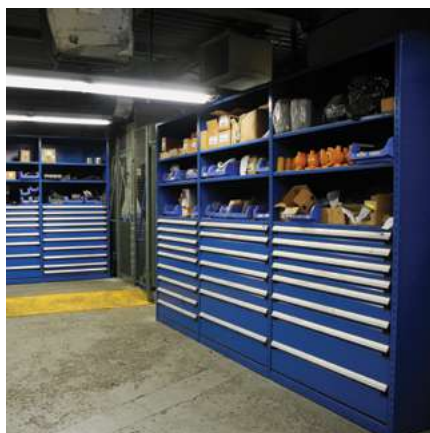
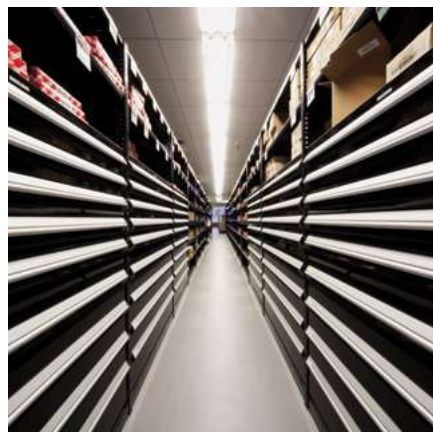

## STACKING BRACKETS

Two sets of mounting brackets can be stacked if a shelf is installed between the two banks of drawers, e.g., 36"H + 18"H.

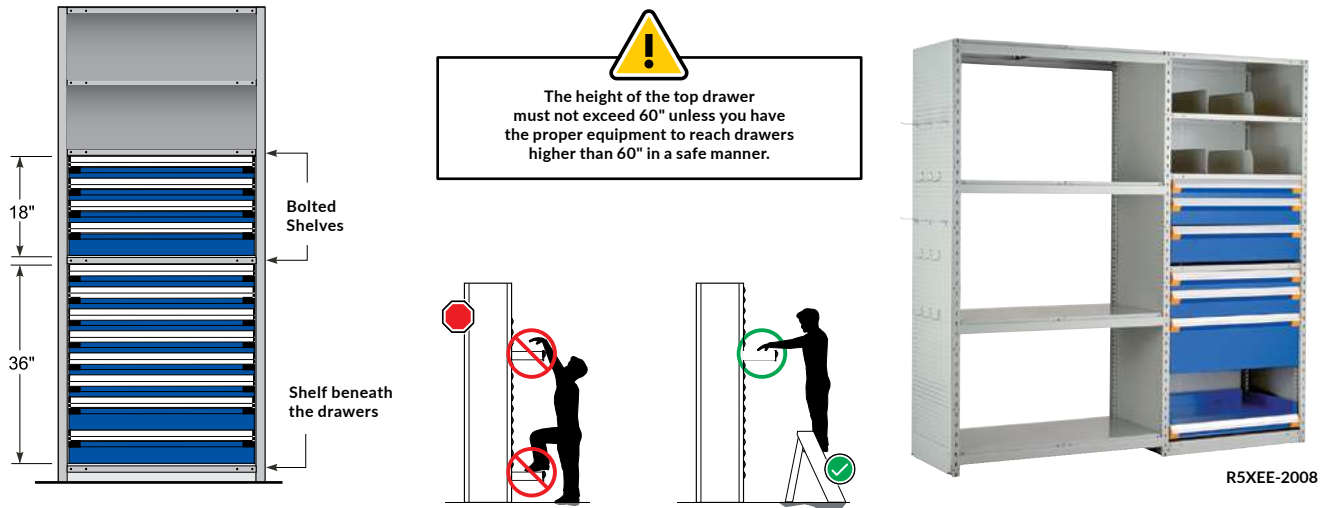

## ASSEMBLY

Assemble with standard tools in three easy steps:

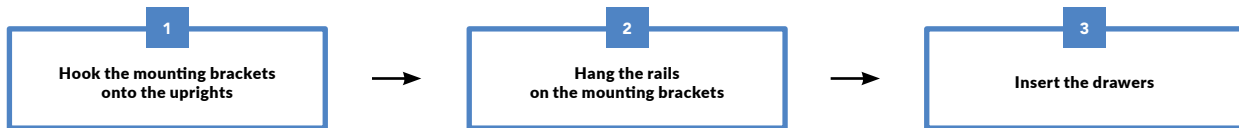

### THE MINIMUM SPACE REQUIRED FOR DRAWERS DEPENDS ON THE HEIGHT OF THE MOUNTING BRACKETS.

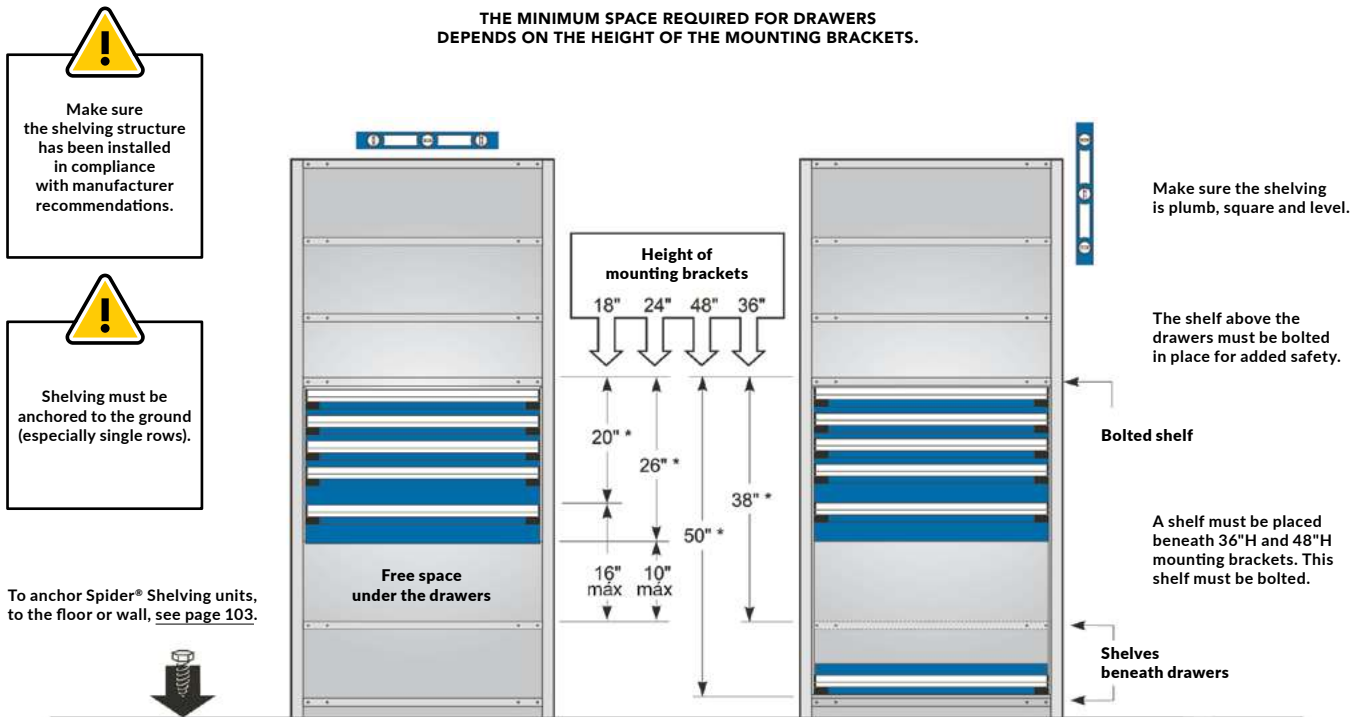

NOTE: \* Subtract 1/2" for shelving with 1 1/2" adjustable shelves (c/c).



## INDEX

## PAGE(S)

Basic Workbench . . . . . 138-139

Preconfigured Models . . . . . 140-143

### Components

Work surface . . . . . 144-146

Structure under the work surface. . . . . 147-153

## BASIC WORKBENCH

Whether you need a basic workbench consisting of two legs and a top, or a more specialized, height-adjustable table for stationary or mobile tasks, you will find a solution for every application.

You will love the versatility of our workbenches and their ability to evolve along with your business needs by simply adding one of the many easy-to-install accessories available.

You also have a choice of several work surface dimensions for each of the surfaces offered: painted steel, stainless steel, laminated wood, plastic laminate, Acrylic/PVC laminate and dissipative tops. Rousseau is your one-stop solution for an easier life!



WSA2019

THE ROUSSEAU DIFFERENCE



"Inverted hat" shaped top part provides excellent rigidity. Optional power supply available.



Doors close and secure the underside of the work surface in the solid and polycarbonate versions.



Drawers run on a precision ball-bearing slide system. Multiple drawer and unit heights available.

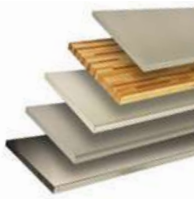

Choose from a variety of work surfaces for specific applications.



Many of our workbenches can be made mobile to better meet your needs.

GENERAL DIMENSIONS

HEIGHTS AVAILABLE



NOTES: The total height shown includes a 1 3/4"-thick top, see page 144. Extensions are available for additional heights, see page 150.

WIDTHS AND DEPTHS AVAILABLE

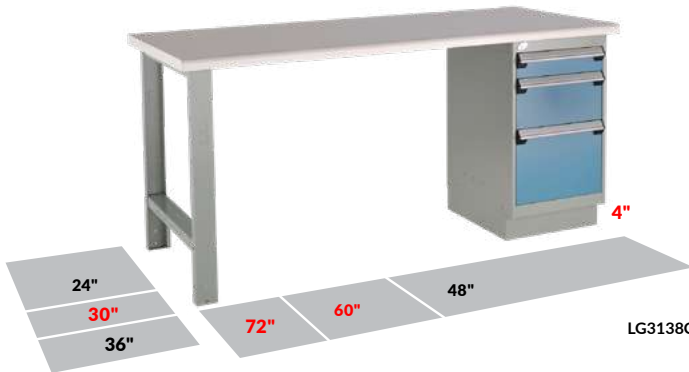

WSW1032



WSA1072



LG2140L3C

NOTE Popular dimensions are shown in red.

# PRECONFIGURED MODELS

## BASIC WORKBENCHES

### BASIC WORKBENCH WITH STRINGER



This table can be made mobile.

- 1 top of your choice
- 2 legs, 27"D x 32"H
- 1 stringer



WSA2031

- The mobile model (35"H total) includes the following additional accessories:
  - 2 pairs of caster adapters for legs
  - 1 pair of 4" rigid casters
  - 1 pair of 4" swivel casters with total-lock brake
  - 1 footrest

NOTE: The legs on mobile models are 28"H

DIMENSIONS				TYPE OF TOP			
W	D	H	PAINTED STEEL	LAMINATED HARDWOOD	PLASTIC LAMINATE	ACRYLIC/PVC	
60"	30"	34"	WS_1031	WS_2031	WS_3031	WS_9031	
72"	30"	34"	WS_1035	WS_2035	WS_3035	WS_9035	
72"	36"	34"	WS_1039	WS_2039	WS_3039	WS_9039	

To order: Complete the product number as follows:

A for a stationary workbench, W for a mobile workbench, e.g., WSW2031



This table can be made mobile.

### WORKBENCH WITH SHELVES

- 1 top of your choice
- 2 legs, 27"D x 32"H
- 2 shelves, 12"D
- 1 stringer



WSA2019

- The mobile model (35"H total) includes the following additional accessories:
  - 2 pairs of caster adapters for legs
  - 1 pair of 4" rigid casters
  - 1 pair of 4" swivel casters with total-lock brake

NOTE: The legs on mobile models are 28"H

DIMENSIONS				TYPE OF TOP			
W	D	H	PAINTED STEEL	LAMINATED HARDWOOD	PLASTIC LAMINATE	ACRYLIC/PVC	
60"	30"	34"	WS_1019	WS_2019	WS_3019	WS_9019	
72"	30"	34"	WS_1023	WS_2023	WS_3023	WS_9023	
72"	36"	34"	WS_1027	WS_2027	WS_3027	WS_9027	

To order: Complete the product number as follows:

A for a stationary workbench, W for a mobile workbench, e.g., WSW2019



This table can be made mobile.

### CLOSED WORKBENCH

- 1 top of your choice
- 2 legs, 27"D x 32"H
- 1 sliding door with L3 lock
- 2 side panels and 1 back panel
- 3 shelves, 12"D
- 2 leg crossbars



WSA2070

- The mobile model (35"H total) includes the following additional accessories:
  - 2 pairs of caster adapters for legs
  - 1 pair of 4" rigid casters
  - 1 pair of 4" swivel casters with total-lock brake

NOTE: The legs on mobile models are 28"H

DIMENSIONS				TYPE OF TOP			
W	D	H	PAINTED STEEL	LAMINATED HARDWOOD	PLASTIC LAMINATE	ACRYLIC/PVC	
60"	30"	34"	WS_1070	WS_2070	WS_3070	WS_9070	
72"	30"	34"	WS_1071	WS_2071	WS_3071	WS_9071	
72"	36"	34"	WS_1072	WS_2072	WS_3072	WS_9072	

To order: Complete the product number as follows:

A for a stationary workbench, W for a mobile workbench, e.g., WSW2070

## ADJUSTABLE WORKBENCH



WSN3KH001E



The WM structure can only be installed on the electric version.

- 1 top of your choice
- 2 open legs for lift mechanism, 27"D×28"H
- 1 lift mechanism
- Anti-slip leveling glides
- Height adjustable from 30" to 42"
- 1 stringer, 17"H
- Compatible with riser shelves
- Load capacity: 825lb.

DIMENSIONS			TYPE	TYPE OF TOP			
W	D	H		PAINTED STEEL	LAMINATED HARDWOOD	PLASTIC LAMINATE*	DISSIPATIVE**
48"	30"	30" to 42"	Electric	WSN1HH001E	WSN2HH001E	WSN3HH001E*	WSN4HH001E**
			Manual	WSN1HH001M	WSN2HH001M	WSN3HH001M*	WSN4HH001M**
60"	30"	30" to 42"	Electric	WSN1KH001E	WSN2KH001E	WSN3KH001E*	WSN4KH001E**
			Manual	WSN1KH001M	WSN2KH001M	WSN3KH001M*	WSN4KH001M**
72"	30"	30" to 42"	Electric	WSN1LH001E	WSN2LH001E	WSN3LH001E*	WSN4LH001E**
			Manual	WSN1LH001M	WSN2LH001M	WSN3LH001M*	WSN4LH001M**

NOTES: These models cannot be made mobile.

\* Load capacity: 725 lb.

† Models with dissipative tops include 1 grounding block, 1 grounding cord and 1 grounding wrist strap, see page 171.

## DESK WITH CLOSED LEGS



WSA3043

- 1 top of your choice
- 1 back panel
- 2 closed legs, 27"D×28"H
- 1 shelf, 12"D

DIMENSIONS			TYPE OF TOP			
W	D	H	PAINTED STEEL	LAMINATED HARDWOOD	PLASTIC LAMINATE	ACRYLIC/PVC
60"	30"	30"	WSA1043	WSA2043	WSA3043	WSA9043
72"	30"	30"	WSA1044	WSA2044	WSA3044	WSA9044

NOTE: These models cannot be made mobile.

## CLOSED DESK WITH CLOSED LEGS



WSA3170

- 1 top of your choice
- 1 back panel
- 2 closed legs, 27"D×32"H
- 3 shelves, 12"D
- 2 leg crossbars
- 1 front finishing panel
- 1 back finishing panel
- 1 sliding door with L3 lock

DIMENSIONS			TYPE OF TOP			
W	D	H	PAINTED STEEL	LAMINATED HARDWOOD	PLASTIC LAMINATE	ACRYLIC/PVC
60"	30"	34"	WSA1170	WSA2170	WSA3170	WSA9170
72"	30"	34"	WSA1171	WSA2171	WSA3171	WSA9171
72"	36"	34"	WSA1172	WSA2172	WSA3172	WSA9172

NOTE: These models cannot be made mobile.

## OPEN DOUBLE WORKBENCH



WSA1904

- 2 tops of your choice
- 3 legs, 27"D×32"H
- 2 stringers
- 4 steel shelves, 12"D
- 1 shelf adapter for common leg
- 1 stringer extension for common leg

DIMENSIONS			TYPE OF TOP			
W	D	H	PAINTED STEEL	LAMINATED HARDWOOD	PLASTIC LAMINATE	ACRYLIC/PVC
8'(2×48")	30"	34"	WSA1902	WSA2902	WSA3902	WSA9902
10'(2×60")	30"	34"	WSA1904	WSA2904	WSA3904	WSA9904
12'(2×72")	30"	34"	WSA1906	WSA2906	WSA3906	WSA9906

NOTE: These models cannot be made mobile.

# PRECONFIGURED MODELS

## CLOSED DOUBLE WORKBENCH



WSA2971

- 2 tops of your choice
- 3 legs, 27"D×32"H
- 2 side panels and 2 back panels
- 4 steel shelves, 12"D
- 1 shelf adapter for common leg
- 2 sliding doors with L3 locks
- 2 side extensions for common leg

DIMENSIONS			TYPE OF TOP			
W	D	H	PAINTED STEEL	LAMINATED HARDWOOD	PLASTIC LAMINATE	ACRYLIC/PVC
8' (2×48")	30"	34"	WSA1971	WSA2971	WSA3971	WSA9971
10' (2×60")	30"	34"	WSA1973	WSA2973	WSA3973	WSA9973
12' (2×72")	30"	34"	WSA1975	WSA2975	WSA3975	WSA9975

NOTE: These models cannot be made mobile.

## WORKBENCH WITH COMPACT CABINET



LG2101C

- 1 top of your choice
- 1 leg, 27"D×32"H
- 1 L Compact Cabinet with 4" base
- The mobile model (35"H total) includes the following additional accessories:
  - 1 pair of 4" rigid casters
  - 1 pair of 4" swivel casters with total-lock brake
  - 1 footrest

NOTES: The legs on mobile models are 28"H.  
Cabinet base not included with mobile model.



This table can be made mobile.

27"D cabinets are recommended for mobile workstations and workstations with WM bench frames.

DIMENSIONS			TYPE OF TOP			
W	D	H	PAINTED STEEL	LAMINATED HARDWOOD	PLASTIC LAMINATE	ACRYLIC/PVC
60"	30"	34"	L__1101C	L__2101C	L__3101C	L__9101C
72"	30"	34"	L__1102C	L__2102C	L__3102C	L__9102C
72"	36"	34"	LH1103C	LH2103C	LH3103C	LH9103C

To order: Complete the product number as follows:

- G** for a stationary workbench with 21"D cabinet (for 30"D workbenches only)
- H** for a stationary workbench with 27"D cabinet (for 30"D and 36"D workbenches only)
- J** for a mobile workbench

## WORKBENCH WITH TWO COMPACT CABINETS



LG2201C

- 1 top of your choice
- 2 L Compact Cabinets with 4" base

DIMENSIONS			TYPE OF TOP			
W	D	H	PAINTED STEEL	LAMINATED HARDWOOD	PLASTIC LAMINATE	ACRYLIC/PVC
60"	30"	34"	L__1201C	L__2201C	L__3201C	L__9201C
72"	30"	34"	L__1202C	L__2202C	L__3202C	L__9202C
72"	36"	34"	LH1203C	LH2203C	LH3203C	LH9203C

To order: Complete the product number as follows:

- G** for a stationary workbench with 21"D cabinet (for 30"D workbenches only)
- H** for a stationary workbench with 27"D cabinet (for 30"D and 36"D workbenches only)

27"D cabinets are recommended for mobile workstations and workstations with WM bench frames.

NOTE: These models cannot be made mobile.



## WORKBENCH WITH SUSPENDED COMPACT CABINET



LG2001

- 1 top of your choice
- 2 legs, 27"D×32"H
- 1 stringer
- 1 L Compact Cabinet, 21"D
- 1 pair of cabinet attachment bars

DIMENSIONS			TYPE OF TOP			
W	D	H	PAINTED STEEL	LAMINATED HARDWOOD	PLASTIC LAMINATE	ACRYLIC/PVC
60"	30"	34"	LG1001	LG2001	LG3001	LG9001
72"	30"	34"	LG1002	LG2002	LG3002	LG9002
72"	36"	34"	LG1003	LG2003	LG3003	LG9003

NOTES: These models cannot be made mobile.  
Load capacity is limited to 50lb. per drawer in a suspended cabinet with RA70 attachment bars.

## DESK WITH COMPACT CABINET



LG3107

- 1 top of your choice
- 1 closed leg, 27"D×28"H
- 1 L Compact Cabinet, 21"D

DIMENSIONS			TYPE OF TOP		
W	D	H	PAINTED STEEL	LAMINATED HARDWOOD	PLASTIC LAMINATE
60"	30"	30"	LG1107	LG2107	LG3107
72"	30"	30"	LG1108	LG2108	LG3108
72"	36"	30"	LH1109	LH2109	LH3109

NOTE: These models cannot be made mobile.



27"D cabinets are recommended for mobile workstations and workstations with WM bench frames.

## WORKBENCH WITH HEAVY-DUTY DRAWERS



R5XDG-3004

- 1 laminated hardwood top
- 2 legs, 27"D×32"H
- 1 drawer unit
- 2 steel shelves
- 1 stringer

DIMENSIONS			TYPE OF TOP
W	D	H	LAMINATED HARDWOOD
48"	30"	34"	R5XDG-3004

NOTE: These models cannot be made mobile.



R5WH5-2007

- 1 laminated hardwood top
- 1 leg, 27"D×32"H
- 1 heavy-duty cabinet (with drawer compartments)

DIMENSIONS			TYPE OF TOP
W	D	H	LAMINATED HARDWOOD
60"	30"	34"	R5WH5-2007

NOTE: These models cannot be made mobile.

## WORK SURFACES

### RESISTANT ACRYLIC / PVC LAMINATE TOP

WS08



- Ideal for assembly stations or for applications using solvents, oils or other chemical products
- Thickness: 1½"
- Color: gray
- Particle board core
- Finish: sheet of gray polymer
- Premium-quality laminate top
- Excellent chemical resistance (can be in prolonged contact with a substance)
- Superior abrasion resistance compared with standard laminate tops
- Superior impact resistance compared with standard laminate tops
- Attractive appearance

### STAINLESS STEEL TOP

WS12



- Top for industrial, maintenance, repair or assembly applications, or for when solvents, oils and other chemical products are used
- Thickness: 1¾" 12ga steel
- #4 brushed finish, attractive appearance
- Includes two steel crossbars for attaching legs
- Includes three 2" x 4" wood crossbars for attaching cabinets and other accessories
- Can be reinforced or soundproofed with a WS75 wood filler
- Excellent corrosion resistance
- Excellent chemical resistance (can be in prolonged contact with a substance)

NOTE: RC35 tops are also compatible with stationary workstations (not recommended for mobile applications), [see page 12](#).

### PAINTED STEEL TOP

WS10



- Top for industrial, maintenance, repair or assembly applications
- Thickness: 1¾"
- Includes two steel crossbars for attaching legs
- Includes three 2" x 4" wood crossbars for attaching cabinets and other accessories
- Can be reinforced or soundproofed with a WS75 wood filler
- Excellent impact resistance
- Powder painted steel

### LAMINATED HARDWOOD TOP

WS14



- Top for general industrial applications
- Thickness: 1¾"
- Made from varnished hardwood slats
- Includes a 90° radius front edge for extra comfort
- High impact resistance
- Attractive appearance

### PLASTIC LAMINATED TOP

WS16



- Top for general use. Ideal for assembly stations, quality control and packaging
- Thickness: 1½"
- Colors: Default is white. For another color, add "-BA" for black or "-GB" for gray to the end of the product number, e.g., WS16-6024A-BA for a black top
- Includes a 90° radius front edge for extra comfort
- Attractive appearance
- Easy to clean



### DISSIPATIVE TOP

WS17



- Top for electronics tasks. Ideal for electronics inspection or assembly stations
- Thickness: 1½"
- Color: white
- Attractive appearance
- Easy to clean
- Includes a 90° radius front edge for extra comfort
- Dissipates electrical charges that can damage electronic components
- The resistance point to point and point to ground is between 10<sup>6</sup> and 10<sup>9</sup> Ω

NOTE: Grounding accessories are sold separately, [see page 183](#).

DIMENSIONS		TYPE OF TOPS					
W	D	ACRYLIC/PVC LAMINATE *	PAINTED STEEL	STAINLESS STEEL	LAMINATED HARDWOOD*	PLASTIC LAMINATE*	DISSIPATIVE*
36"	24"				WS14-3624A	WS16-3624A	
	30"				WS14-3630A	WS16-3630A	
48"	24"	WS08-4824A	WS10-4824	WS12-4824	WS14-4824A	WS16-4824A	WS17-4824A
	30"	WS08-4830A	WS10-4830	WS12-4830	WS14-4830A	WS16-4830A	WS17-4830A
	36"	WS08-4836A	WS10-4836	WS12-4836	WS14-4836A	WS16-4836A	WS17-4836A
60"	24"	WS08-6024A	WS10-6024	WS12-6024	WS14-6024A	WS16-6024A	WS17-6024A
	30"	WS08-6030A	WS10-6030	WS12-6030	WS14-6030A	WS16-6030A	WS17-6030A
	36"	WS08-6036A	WS10-6036	WS12-6036	WS14-6036A	WS16-6036A	WS17-6036A
72"	24"	WS08-7224A	WS10-7224	WS12-7224	WS14-7224A	WS16-7224A	WS17-7224A
	30"	WS08-7230A	WS10-7230	WS12-7230	WS14-7230A	WS16-7230A	WS17-7230A
	36"	WS08-7236A	WS10-7236	WS12-7236	WS14-7236A	WS16-7236A	WS17-7236A

NOTES: \* Please check with your Customer Service representative for lead times. 21"D cabinets are not compatible with 30"D and 36"D WS10 / 12 tops.  
 Please refer to technical guide W54 for load capacities based on the configuration. 27"D cabinets are compatible with 30"D and 36"D WS10 / 12 tops.  
 21"D cabinets are compatible with 24"D WS10 / 12 tops.

## STEEL TOP CROSSBAR

### WS11

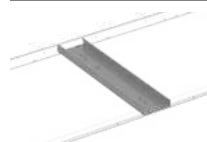

- Painted steel
- Installs in the center of a steel top (WS10 or WS12) for extra reinforcement
  - To add an extra leg
  - To add another cabinet
  - Will reduce deflexion (will not increase capacity)

PRODUCT NO.	W×D
WS11-24	6" × 24"
WS11-30	6" × 30"
WS11-36	6" × 36"

## BACK OR SIDE STOPS

### WS18 / WS98



- Painted steel: WS18
- Stainless steel: WS98
- Can be installed on back or sides depending on top dimensions
- Compatible with all WS tops
- Height: 5" Extends above top by approx. 3/4"
- To order: Specify the type of steel required, e.g., WS18-2405

PRODUCT NO.	LENGTH
WS_-2405	24"
WS_-3005	30"
WS_-3605	36"
WS_-4805	48"
WS_-6005	60"
WS_-7205	72"

## WOOD FILLER FOR STEEL TOP

### WS75



- Made from wooden crossbars
- Inserts into WS10 and WS12 steel tops for soundproofing
- Increases sturdiness of steel tops
- Enables accessories to be installed under the work surface
- Depths available: 24", 30" and 36"
- To order: Specify the depth required

PRODUCT NO.	WIDTH
WS75-48__	48"
WS75-60__	60"
WS75-72__	72"

## SLIDING KEYBOARD TRAY

### WS90-01



- Installs under all types of top
- Mouse tray slides to the left or right as required
- Usable surface area: 21 1/2"W × 11 3/16"D
- Mouse tray: 9 3/8"W × 9 1/8"D
- Width taken up under the work surface: 22"

PRODUCT NO.	COLOR
WS90-01	Black

## WOOD CROSSBAR FOR STEEL TOP

### WS76



- Enables cabinets, hanging cabinets, drawer units and back panels to be installed under a steel top
- Depths available: 24", 30" and 36"
- To order: Specify the depth required

PRODUCT NO.	W×H
WS76-0204__	4" × 2"

NOTE: Three crossbars (4" × 2") are included with each WS10 and WS12 steel top.

## ADJUSTABLE KEYBOARD TRAY

### WS90-02



- Mount with an articulating arm for working while sitting or standing
- Installs under all types of top
- Includes:
  - Mouse tray that slides to the left or right
  - Ergonomic palm wrist
- Slides under the work surface when not in use
- Heavy-duty construction
- Usable surface area: 9 1/2" × 20 1/2"
- Mouse tray: 9 3/8" × 9"
- Width taken up under the work surface: 30"

PRODUCT NO.	COLOR
WS90-02	Black

# COMPONENTS – WORK SURFACES

## SIDE BRACKETS FOR TOP

RA73



- Load capacity: 500lb. per pair, 1,000lb. for four
- Compatible with all cabinet depths
- Compatible with all types of top
- Galvanized steel

PRODUCT NO.	
RA73-02	One pair
RA73-04	Two pairs

## CPU HOLDER

WS92



- Installs under all types of top
- Includes a handle for adjusting the width of the plastic side support
- Height adjustable to hold computer cases from 3½"W to 9¼"W by 12½"H to 22½"H
- Width: 8⅞" to 11½"
- Depth: 6¾" (8½" with handle)
- Height: 18" to 26"

PRODUCT NO.	COLOR
WS92-01	Black

## LAMINATED HARDWOOD TOP FOR SHELVING

SR90



- For installation between two shelving units
- A pair of SH74-24 supports must be ordered to install this top

PRODUCT NO.	W × D
SR90-6024A	60" × 24"
SR90-7224A	72" × 24"

## TOP SUPPORTS

SH74



- Sold in pairs
- Supports an SR90 hardwood top between two shelving units
- Easy hook-on assembly

PRODUCT NO.	DEPTH
SH74-24	24"

## STRUCTURAL COMPONENTS

### OPEN LEG



WS20

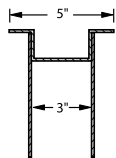

- Three basic heights available: 28", 32" and 34"
- WS21 extensions can be added if required
- "Inverted hat" shaped top part provides excellent rigidity
- A second WS24 leg crossbar can be added for installation of WS50 shelves
- Can be closed with a WS62 side panel
- To add a power strip with two 12A outlets, add -20 to the product number
- To add a power strip with one 12A outlet and two USB ports (1 A, 1 C), add -22 to the product number

PRODUCT NO.	D × H	WORK SURFACE DEPTH
WS20-2128-__	21" × 28"	24" and 30"
WS20-2132-__	21" × 32"	24" and 30"
WS20-2134-__	21" × 34"	24" and 30"
WS20-2728-__	27" × 28"	30" and 36"
WS20-2732-__	27" × 32"	30" and 36"
WS20-2734-__	27" × 34"	30" and 36"

### CLOSED LEG



WS25

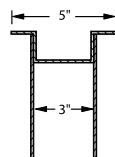

- Fulfills aesthetic requirements of certain work environments
- Three basic heights available: 28", 32" and 34"
- "Inverted hat" shaped top part provides excellent rigidity
- One closed side. There are no holes on the front or exterior side;
- there are fixing zones for accessories on the interior side
- A second WS24 leg crossbar can be added for installation of WS50 shelves
- To add a power strip with two 12A outlets, add L-20 to the product number for the left leg and R-20 for the right leg
- To add a power strip with one 12A outlet and two USB ports (1 A, 1 C), add L-22 to the product number for the left leg and R-22 for the right leg

PRODUCT NO.	D × H	WORK SURFACE DEPTH
WS25-2128-__	21" × 28"	24" and 30"
WS25-2132-__	21" × 32"	24" and 30"
WS25-2134-__	21" × 34"	24" and 30"
WS25-2728-__	27" × 28"	30" and 36"
WS25-2732-__	27" × 32"	30" and 36"
WS25-2734-__	27" × 34"	30" and 36"

## FLOOR ANCHORING HARDWARE KIT

WS80



- For anchoring legs to the ground
- Includes four bolts for concrete floors

PRODUCT NO.
WS80

NOTES: Compatible with WS26 leveling glides.  
Not compatible with WS21 leg extensions.

# COMPONENTS – STRUCTURE UNDER THE WORK SURFACE

## STRINGER

WS22



- Attaches between the two legs at the rear to strengthen the structure
- Available in standard widths that correspond to work surface widths
- Can act as a back for shelves under the work surface

PRODUCT NO.	WIDTH	WORK SURFACE WIDTH
WS22-4805	39"	48"
WS22-6005	51"	60"
WS22-7205	63"	72"



## LEG CROSSBAR

WS24



- Provides space for a second row of shelves under the work surface
- Can be mounted to a WS20 open leg or WS25 closed leg
- To add a power strip with two 12A outlets, add -20 to the product number
- To add a power strip with one 12A outlet and two USB ports (1 A, 1 C), add -22 to the product number

PRODUCT NO.	LEG DEPTH
WS24-21-__	21"
WS24-27-__	27"

## CORNER GUSSETS FOR LEG

WS28



- Sold in pairs
- Installs on a leg and under the work surface to reinforce the structure
- Recommended for mobile workstations with a particle board or plastic laminate top

PRODUCT NO.
WS28-01

NOTE: For load capacities for mobile workstations with gussets, please refer to technical guide W54 or contact your Customer Service representative. Not compatible with WS10 and WS12 steel tops.

## ADJUSTABLE FOOTREST

WS23



- Adjustable width; adjusted by sliding the inner part in or out
- Required for all mobile workstations
- Attaches to the leg crossbars or the cabinet sides to strengthen the structure

PRODUCT NO.	WIDTH ADJUSTMENT
WS23-1624	16" to 24"
WS23-2440	24" to 40"
WS23-4072	40" to 72"

FOOTRESTS AVAILABLE BASED ON CONFIGURATION	WORK SURFACE WIDTH		
	48"	60"	72"
2 legs	WS23-2440	WS23-4072	WS23-4072
1 leg and 1 L Compact Cabinet	WS23-2440	WS23-2440	WS23-4072
2 L Compact Cabinets	-	WS23-1624	WS23-2440
1 leg and 1 RA30-2427 cabinet	-	WS23-2440	WS23-4072
1 leg and 1 RA30-3027 cabinet	-	WS23-2440	WS23-2440
1 leg and 1 RA30-3624 cabinet	-	WS23-1624	WS23-2440

## WALL-MOUNTED OPEN LEG

WS95



- Load capacity: 500lb. per leg, 1,000lb. per pair (if wall and wall anchoring are of sufficient strength)
- Anchoring hardware not provided by Rousseau
- Intended for 24"D, 30"D and 36"D tops
- Compatible with all types of top available from Rousseau
- Compatible with WS18 back stops and WM uprights
- WS96 crossbars and a 12"D WS50 shelf (optional add-on) can be installed on this product

PRODUCT NO.	D x H
WS95-2428	22 <sup>3</sup> / <sub>16</sub> " x 29 <sup>7</sup> / <sub>16</sub> "

NOTE: For more information on our wall-mounted solutions: [see page 212](#).

## CROSSBAR FOR WALL-MOUNTED LEG

WS96

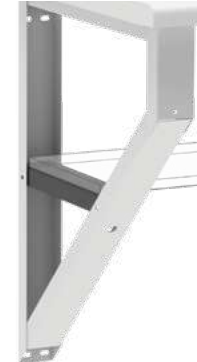

- For installation of a 12"D WS50 shelf between two WS95 wall-mounted legs

PRODUCT NO.	DEPTH
WS96-24	13 <sup>3</sup> / <sub>16</sub> "

# COMPONENTS – STRUCTURE UNDER THE WORK SURFACE

## STEEL SHELF

WS50 / WS56



- Painted steel: WS50
- Stainless steel: WS56
- Thickness: 1½"
- Installs on WS24 leg crossbars or on WM27 shelf supports, see pages 147 and 164
- Shelf combinations:
  - 21"D legs: One 6"D shelf + one 12"D shelf
  - 27"D legs: Two 12"D shelves
- To order: Specify the type of steel required

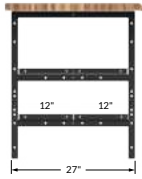
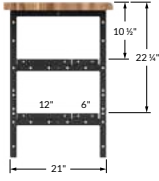

PRODUCT NO.	W × D	WORK SURFACE WIDTH
WS__-4806	45" × 6"	48"
WS__-4812	45" × 12"	48"
WS__-6006	57" × 6"	60"
WS__-6012	57" × 12"	60"
WS__-7206	69" × 6"	72"
WS__-7212	69" × 12"	72"

## SIDE PANEL

WS62



- Installs on open legs
- Compatible with 28"H, 32"H and 34"H legs

PRODUCT NO.	D × H	LEG DEPTH
WS62-2128	20" × 25"	21"
WS62-2728	26" × 25"	27"

## BACK PANEL

WS63



- Installs behind WS20 open or WS25 closed legs
- Widths available:
  - 48" (one part)
  - 60" and 72" (two parts each)
- Compatible with 28"H, 32"H and 34"H legs

PRODUCT NO.	W × H	SURFACE WIDTH
WS63-4828	39" × 24"	48"
WS63-6028	51" × 24"	60"
WS63-7228	63" × 24"	72"

## SIDE EXTENSION FOR COMMON LEG

WS64

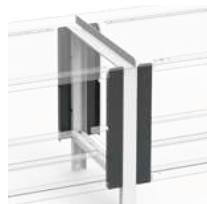

- Includes one extension at the front and one at the back
- Required for mounting WS60 sliding doors or WS63 back panels to a common leg

PRODUCT NO.	HEIGHT
WS64-0325	25"

## SHELF ADAPTER FOR COMMON LEG

WS78



- Must be ordered to install WS50/WS56 shelves on a common leg

PRODUCT NO.	LEG DEPTH
WS78-0321	21"
WS78-0327	27"

NOTE: Not compatible with WS62 side panels.

## STRINGER EXTENSION FOR COMMON LEG

WS79



- Must be ordered to install a WS22 stringer on a common leg

PRODUCT NO.
WS79-0305

## ADAPTER FOR WS50 SHELF

RC15



- For installation of a WS50 shelf between two RA30 or two LA30 cabinets
- For installation of a WS50 shelf between an RA30 cabinet and a WS20 leg or between an LA30 cabinet and a WS20 leg
- Installs in holes on the side of the cabinet (knockouts provided)

PRODUCT NO.	DEPTH
RC15-12	12" (one 12" or two 6" shelves)
RC15-18	18" (12" + 6" or three 6" shelves)
RC15-24	24" (two 12" or four 6" shelves)

# COMPONENTS – STRUCTURE UNDER THE WORK SURFACE

## POWER OUTLET MODULE



### WS7B



- Mounts directly under a wood or laminate work surface
- Includes 15' power cord
- Two models available: two 12A outlets, or one 12A outlet and two USB ports (1 A, 1 C),

PRODUCT NO.	OPTIONS
WS7B-20	2 power outlets
WS7B-22	1 power outlet + 2 USB ports (1 A, 1 C),

## POWER OUTLET STRIP



- 15A power outlet strip with circuit breaker
- Mounts horizontally under a work surface or riser shelf
- Mounting hardware included

PRODUCT NO.	LENGTH	EXTENSION CORD	NO. OF OUTLETS
70000500	9"	6'	5, without on/off switch
70000505	12"	6'	6, with on/off switch
70000506	12"	15'	6, with on/off switch

## SLIDING DOORS

### WS60 / WS61



- Sliding doors: WS60
- Sliding polycarbonate doors: WS61
- Closes and secures the area under the work surface (standard L3 lock included)
- Compatible with workstations with 28"H, 32"H and 34"H legs
- To order: Specify the type of door required,
- e.g., WS61-4828L3 for 39"W x 24"H sliding polycarbonate doors

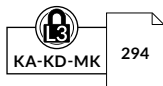

PRODUCT NO.	W x H	WORK SURFACE WIDTH
WS_-4828L3	39" x 24"	48"
WS_-6028L3	51" x 24"	60"
WS_-7228L3	63" x 24"	72"

## PAPER AND CARDBOARD SPOOL HOLDER

### WS86



- Installs under the work surface on WS24 leg crossbars (sold separately)
- Includes two end brackets and one rod
- Rod diameter: 1"
- Spool is inserted by pivoting one end of the rod, only one person needed
- 75lb. load capacity

PRODUCT NO.	WIDTH	COLOR
WS86-48	48"	Black
WS86-60	60"	Black
WS86-72	72"	Black

NOTE: Up to two can be installed on a WS24-21 crossbar and up to three on a WS24-27.



# COMPONENTS – STRUCTURE UNDER THE WORK SURFACE

## FINISHING PANEL

WS65 / WS66



- Front finishing panel: WS65
- Rear finishing panel: WS66
- Closes the space under a set of sliding doors on both the front and back of the workstation
- Three basic heights available: 4", 8" and 10"
- Compatible with workstations with 28"H, 32"H and 34"H closed legs
- To order: Specify the finishing panel and height required, e.g., WS65-4808 for a front finishing panel 48"W×8"H

PRODUCT NO.	W×H	CLOSED LEG HEIGHT
WS__-4804	48"×4"	28"
WS__-4808	48"×8"	32"
WS__-4810	48"×10"	34"
WS__-6004	60"×4"	28"
WS__-6008	60"×8"	32"
WS__-6010	60"×10"	34"
WS__-7204	72"×4"	28"
WS__-7208	72"×8"	32"
WS__-7210	72"×10"	34"

## PACKAGING SHEAR CUTTER

WM87



- For cutting paper, corrugated cardboard, plastic, packing foam, bubble wrap, etc. For materials up to 36" wide
- Cuts in both directions

PRODUCT NO.	MATERIAL CUTTING WIDTH	OVERALL WIDTH
WM87-01	36"	48"

## LEVELING GLIDES

WS26



For leg WS20/25

- Sold in pairs
- Adjusts the height of legs on uneven surfaces
- For use with an L Compact Cabinet, see LA74 Leveling Glide Kit, [see page 35](#)

PRODUCT NO.
WS26



With leg extensions WS21

## LEG EXTENSIONS / CASTER ADAPTERS

WS21



- Compatible with open legs only
- Sold in pairs
- Three basic heights available: 3", 6" and 9"
- Leg height can be adjusted with the 6"H and 9"H models
- Casters can be installed on the 3"H and 6"H models;
- Casters cannot be used with the 9"H model

PRODUCT NO.	HEIGHT	ADJUSTMENT POSSIBLE	CASTER TYPE
WS21-0306	3"	–	4" or 6"
WS21-0606	6"	Up to 3"	4" or 6"
WS21-0904	9"	Up to 6"	Not compatible

## CASTERS



\_B81-03



\_B84-03



RB8E-02

- Sold in pairs
- Three types of casters available: rigid, swivel and swivel with total-lock brake (on wheel and swivel)
- Dark gray, non-marking polyurethane tread
- Superior industrial quality
- To order: Specify the type of cabinet required (L or R), e.g., RB81-01

PRODUCT NO.	CASTER TYPE	LOAD CAPACITY	HEIGHT	
			WHEEL HEIGHT	TOTAL
_B81-01	Rigid	440 lb	4"	5¼"
_B81-02	Swivel	440 lb	4"	5¼"
_B81-03	Swivel with total-lock brake	440 lb	4"	5¼"
_B84-01	Rigid	1100 lb	6"	7½"
_B84-02	Swivel	1100 lb	6"	7½"
_B84-03	Swivel with total-lock brake	1100 lb	6"	7½"
RB8E-02	Swivel caster directional locking kit for swivel casters (×2)			

NOTES: Not compatible with 18"W R cabinets.  
 The casters install directly under an R cabinet (without base).  
 An LB93 cart or LB96 base for casters is required for use with an L compact cabinet, [see page 65](#)



# COMPONENTS – STRUCTURE UNDER THE WORK SURFACE

## QUIET CASTERS



- Sold in pairs
- Smooth and quieter rolling
- Two types of casters available: rigid and swivel with total-lock brake (on wheel and swivel)
- Blue, hard-wearing polyurethane tread for quiet and easy maneuvering
- Superior industrial quality
- To order: Specify the type of cabinet required (L or R), e.g., RB8C-01

PRODUCT NO.	CASTER TYPE	LOAD CAPACITY	HEIGHT	
			WHEEL HEIGHT	TOTAL
_B8C-01	Quiet, rigid	660 lb	4"	5 $\frac{1}{8}$ "
_B8C-03	Quiet, swivel with total-lock brake	660 lb	4"	5 $\frac{1}{8}$ "
_B8D-01	Quiet, rigid	1100 lb	6"	7 $\frac{1}{2}$ "
_B8D-03	Quiet, swivel with total-lock brake	1100 lb	6"	7 $\frac{1}{2}$ "

NOTES: Not compatible with 18"W R cabinets.  
 The casters install directly under an R cabinet (without base).  
 An LB93 cart or LB96 base for casters is required for use with an L compact cabinet, [see page 65](#).



# COMPONENTS – STRUCTURE UNDER THE WORK SURFACE

## PRECONFIGURED CABINETS

HERE ARE SOME OF OUR MOST POPULAR PRECONFIGURED CABINET MODELS FOR WORKSTATIONS

### L Compact Cabinets:

- 27"D cabinets are required for 36"D workstations and recommended for workstations with WM bench frames and for 30"D mobile workstations
- Order LG31 hanging file bars to hang letter size (8½" × 11") or legal size (8½" × 14") files in a 12"H drawer, [see page 32](#)
- Can be ordered with or without a central lock (L3). To order a central locking system, add L3 to the product number
- To add an L50 electronic lock to a door or to your L cabinet, [see page 37](#)



### R Heavy-Duty Cabinets:

- The preconfigured models in this section include a 2" recessed base and a lock on the cabinet housing
- 12"H drawers are designed to hold hanging file bars. Order RG30 or RG31 hanging file bars, [see page 246](#)
- To add an L50 electronic lock to a door or to your R cabinet, [see page 11](#)

### IMPORTANT

Drawer compartments are included in all models.

To order drawers without compartments, replace the last two digits of the model number with the next even number up.

e.g., L3ABD-2851 with L3ABD-2852 without



### NUMBER OF COMPARTMENTS (LAYOUT CODE)

DRAWER DIMENSIONS (W×D)	3"H TO 5"H	6"H TO 8"H	9"H AND HIGHER
18" × 21"	9 (0206)	6 (0104)	4 (0102)
18" × 27"	9 (0206)	6 (0104)	4 (0102)
24" × 21"	12 (0308)	9 (0206)	4 (0102)
24" × 27"	20 (0316)	12 (0209)	6 (0104)
30" × 21"	24 (0518)	12 (0308)	6 (0203)
30" × 27"	25 (0420)	12 (0308)	9 (0206)

### 28" H L COMPACT CABINETS - WITHOUT BASE



4"  
5"  
5"  
5"  
5"

5 DRAWERS  
L3ABD-2861\_\_ 18" × 21" × 28"  
L3ABG-2861\_\_ 18" × 27" × 28"



3"  
3"  
6"  
12"

4 DRAWERS  
L3ABD-2871\_\_ 18" × 21" × 28"  
L3ABG-2871\_\_ 18" × 27" × 28"



6"  
6"  
12"

3 DRAWERS  
L3ABD-2873\_\_ 18" × 21" × 28"  
L3ABG-2873\_\_ 18" × 27" × 28"



3"  
3"  
4"  
4"  
6"

6 DRAWERS  
L3ABD-2867\_\_ 18" × 21" × 28"  
L3ABG-2867\_\_ 18" × 27" × 28"



5"  
5"  
6"  
8"

4 DRAWERS  
L3ABD-2869\_\_ 18" × 21" × 28"  
L3ABG-2869\_\_ 18" × 27" × 28"

### 32" H L COMPACT CABINETS – WITH 4" H BASE



6"  
6"  
6"  
6"

4 DRAWERS  
L3ABD-2851\_\_C 18" × 21" × 32"  
L3ABG-2851\_\_C 18" × 27" × 32"



24"

1 DOOR / 1 AJUSTABLE SHELF  
L3ABD-2854\_\_C 18" × 21" × 32"  
L3ABG-2854\_\_C 18" × 27" × 32"



6"  
6"  
12"

3 DRAWERS  
L3ABD-2855\_\_C 18" × 21" × 32"  
L3ABG-2855\_\_C 18" × 27" × 32"



12"  
12"

2 DRAWERS  
L3ABD-2857\_\_C 18" × 21" × 32"  
L3ABG-2857\_\_C 18" × 27" × 32"



3"  
3"  
6"  
12"

4 DRAWERS  
L3ABD-2859\_\_C 18" × 21" × 32"  
L3ABG-2859\_\_C 18" × 27" × 32"

### R HEAVY-DUTY CABINETS – WITH 2" H BASE



4"  
4"  
6"  
12"

4 DRAWERS  
R5ACD-3013 24" × 21" × 32"  
R5ACG-3013 24" × 27" × 32"



3"  
3"  
4"  
4"  
8"

6 DRAWERS  
R5ACD-3017 24" × 21" × 32"  
R5ACG-3017 24" × 27" × 32"



3"  
3"  
6"  
14"

4 DRAWERS  
R5ADD-3015 30" × 21" × 32"  
R5ADG-3015 30" × 27" × 32"



6"  
6"  
7"  
7"

4 DRAWERS  
R5ADD-3017 30" × 21" × 32"  
R5ADG-3017 30" × 27" × 32"



4"  
4"  
4"  
6"  
6"  
6"  
6"

8 DRAWERS  
R5ADD-4409 30" × 21" × 46"  
R5ADG-4409 30" × 27" × 46"

# COMPONENTS – STRUCTURE UNDER THE WORK SURFACE

## STANDARD DRAWER UNITS

To order a drawer lock with the drawer unit, add **L3** to the drawer product number.



100lb. maximum load capacity for each drawer in a unit to avoid destabilizing the workstation when drawers are opened.

### 6"H AND 7"H DRAWER UNIT



1 DRAWER	
LD77-3201__	18" x 21" x 6"
LD77-4201__	18" x 27" x 6"



1 DRAWER	
LD77-3202__	18" x 21" x 7"
LD77-4202__	18" x 27" x 7"

NOTE: LD77 units are not stackable and not compatible with LD76 covers.

### 12"H DRAWER UNIT



2 DRAWERS	
LD75-3203__	18" x 21" x 12"
LD75-4203__	18" x 27" x 12"



2 DRAWERS	
LD75-3204__	18" x 21" x 12"
LD75-4204__	18" x 27" x 12"

### 9"H DRAWER UNIT



1 DRAWER	
LD75-3201__	18" x 21" x 9"
LD75-4201__	18" x 27" x 9"



2 DRAWERS	
LD75-3202__	18" x 21" x 9"
LD75-4202__	18" x 27" x 9"

### 15"H DRAWER UNIT



2 DRAWERS	
LD75-3206__	18" x 21" x 15"
LD75-4206__	18" x 27" x 15"



1 DRAWER	
LD75-3207__	18" x 21" x 15"
LD75-4207__	18" x 27" x 15"

## HEAVY-DUTY DRAWER UNITS

To order a drawer lock with the drawer unit, add **L3** to the drawer product number.



200lb. maximum load capacity per unit to avoid destabilizing the workstation when drawers are opened.

### 24"W DRAWER UNIT



1 DRAWER	
RD77-24210801__	24" x 21" x 8"
RD77-24270801__	24" x 27" x 8"



2 DRAWERS	
RD77-24210802__	24" x 21" x 8"
RD77-24270802__	24" x 27" x 8"

### 30"W DRAWER UNIT



1 DRAWER	
RD77-30210801__	30" x 21" x 8"
RD77-30270801__	30" x 27" x 8"



2 DRAWERS	
RD77-30210802__	30" x 21" x 8"
RD77-30270802__	30" x 27" x 8"

### 36"W DRAWER UNIT



1 DRAWER	
RD77-36240801__	36" x 24" x 8"
RD77-36270801__	36" x 27" x 8"



2 DRAWERS	
RD77-36240802__	36" x 24" x 8"
RD77-36270802__	36" x 27" x 8"

### 48"W DRAWER UNIT



1 DRAWER	
RD77-48240801__	48" x 24" x 8"
RD77-48270801__	48" x 27" x 8"

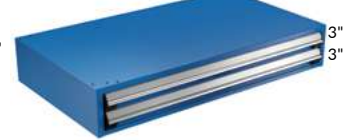

2 DRAWERS	
RD77-48240802__	48" x 24" x 8"
RD77-48270802__	48" x 27" x 8"



INDEX	PAGE(S)
Workcenters – Storage Above the Work Surface – WS / WM	154-155
Preconfigured Models . . .	156-160
<b>Components</b>	
Structure Above the Work Surface . . . . .	161-171

## WORKCENTERS – STORAGE ABOVE THE WORK SURFACE – WS / WM

Whether you are installing workstations for a production or assembly line, or a custom layout for your machine tool workshop, our line of products feature an impressive selection of accessories that are sure to exceed your expectations. From shipping and receiving to your foreman's office, you will love the quality and variety of products to choose from. One of the great features of the Rousseau WM Bench Frame is that it's so easy to reconfigure – no tools required! By simply adding or rearranging accessories, it can evolve to suit your changing business needs.

You also have a choice of several work surface dimensions for each of the surfaces offered: painted steel, stainless steel, laminated wood, plastic laminate, Acrylic / PVC laminate and dissipative tops. Rousseau is your one-stop solution for an easier life!



LC3011C

# WORKCENTERS – STORAGE ABOVE THE WORK SURFACE

## THE ROUSSEAU DIFFERENCE



From top to bottom, you will find a Rousseau solution for even the most specialized requirements.



Easy and tool-free reconfiguration means that your workstation can evolve in line with your needs.



With our vast range of standard accessories, you can build a highly personalized workcenter.



Our WM frames can be installed on most industrial workbenches available on the market. The six fixing zones mean limited interference and endless possibilities.

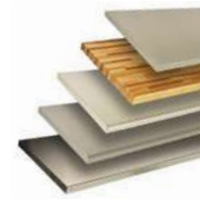

Choose from a variety of work surfaces for specific applications.

## GENERAL DIMENSIONS

WIDTH × HEIGHT ABOVE

RISER SHELVES

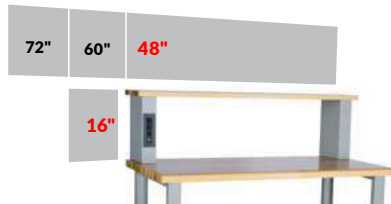

WM BENCH FRAMES

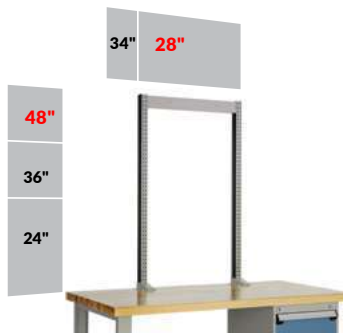
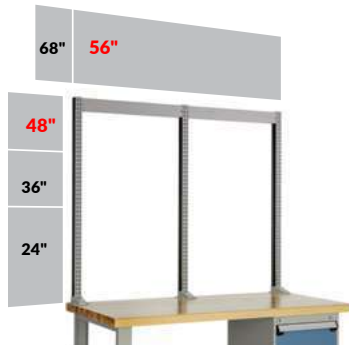

WSC2018



LC6003



LC3125C

NOTE Popular dimensions are shown in red.

# PRECONFIGURED MODELS

## WORKBENCHES WITH RISER SHELVES

### BASIC ELECTRONIC WORKBENCH



WSA4073

- 1 top of your choice
- 2 legs, 27"D × 32"H
- 1 back stop
- 1 stringer
- 1 pair of risers with power outlets on each riser
- 1 shelf, 12"D, same material as the top
- 1 shelf back

DIMENSIONS			TYPE OF TOP		
W	D	H	LAMINATED HARDWOOD	PLASTIC LAMINATE	DISSIPATIVE
60"	30"	34"	WSA2073	WSA3073	WSA4073
72"	30"	34"	WSA2074	WSA3074	WSA4074
72"	36"	34"	WSA2075	WSA3075	WSA4075

NOTE: Models with dissipative tops include 1 grounding block, 1 grounding cord and 1 grounding wrist strap, [see page 171](#).

### ELECTRONICS WORKBENCH WITH COMPACT CABINET



LG4104C

- 1 top of your choice
- 1 leg, 27"D × 32"H
- 1 L Compact Cabinet with 4" base
- 1 back stop
- 1 pair of risers with power outlets on each riser
- 1 shelf, 12"D, same material as the top
- 1 shelf back

DIMENSIONS			TYPE OF TOP		
W	D	H	LAMINATED HARDWOOD	PLASTIC LAMINATE	DISSIPATIVE
60"	30"	34"	LG2104C	LG3104C	LG4104C
72"	30"	34"	LG2105C	LG3105C	LG4105C
72"	36"	34"	LH2106C	LH3106C	LH4106C

NOTE: Models with dissipative tops include 1 grounding block, 1 grounding cord and 1 grounding wrist strap, [see page 171](#).

## WORKBENCHES WITH WM BENCH FRAMES

### ELECTRONICS WORKSTATION



LC3002C

- 1 double WM bench frame
- 1 tiltable shelf
- 2 plastic bin rails
- 1 power outlet module
- 1 monitor tray with arm
- 1 tiltable pan
- 1 storage cabinet with door
- 1 pair of cantilever overhead supports
- 1 overhead LED workstation light
- 7 partial dividers (4 inside storage cabinet)
- 5 plastic bins
- 1 lamp with magnifier and LED light
- 1 adapter for lamp or light-duty arm
- 1 leg, 27"D × 32"H
- 1 L Compact Cabinet with 4" base
- 1 dissipative top
- 1 grounding block
- 1 ground wrist strap

DIMENSIONS			TYPE OF TOP
W	D	H	DISSIPATIVE TOP
60"	30"	82"	LC3002C

## BASIC WORKSTATION



WSC0133

- 1 single WM frame
- 2 tiltable shelves
- 2 plastic bin rails
- 1 vertical adapter for power outlet strip and pneumatic connection
- 1 power outlet strip
- 6 partial dividers
- 5 plastic bins
- 2 legs, 27"D×32"H
- 1 stringer
- 1 painted steel top

DIMENSIONS			TYPE OF TOP	
W	D	H	PAINTED STEEL TOP	
60"	30"	82"	WSC0133	

## PACKAGING STATION



WSM0006

- 2 multi-purpose uprights
- 2 steel shelves
- 2 structural shelf supports
- 6 sliding dividers
- 1 vertical adapter for power outlet strip and pneumatic connection
- 1 power outlet strip
- 1 document holder with arm
- 2 legs, 27"D×32"H
- 1 stringer
- 1 laminated hardwood top
- 1 paper and cardboard spool support
- 2 leg crossbars

DIMENSIONS			TYPE OF TOP	
W	D	H	LAMINATED HARDWOOD	
60"	30"	82"	WSM0006	



**SOLD SEPARATELY**

Packaging Shear Cutter WM87-01  
See page 150, for product details

## END-OF-AISLE WORKSTATION



WSM0017

- 2 closed legs, 27"D×32"H
- 1 laminated hardwood top
- 1 sliding keyboard tray (WS90-01) or adjustable keyboard tray (WS90-02) (except on model without keyboard tray WSM0018)
- 1 single WM frame
- 2 tiltable shelves
- 6 partial dividers
- 1 power outlet strip
- 1 vertical adapter for power outlet strip and pneumatic connection
- 1 document holder with arm
- 1 tackboard / whiteboard
- 1 panel bracket kit
- 2 leg crossbars

DIMENSIONS			KEYBOARD TRAY		
W	D	H	WS90-01 SLIDING	WS90-02 ADJUSTABLE	WITHOUT KEYBOARD TRAY
36"	30"	82"	WSM0016	WSM0017	WSM0018

# PRECONFIGURED MODELS

## QUALITY CONTROL WORKSTATION



LC3003C

- 1 single WM bench frame
- 1 tiltable shelf
- 1 overhead LED workstation light
- 1 pair of cantilever overhead supports
- 1 power outlet module
- 1 LCD monitor and keyboard arm
- 1 tackboard / whiteboard
- 1 panel bracket kit
- 3 partial dividers
- 1 leg, 27"D×32"H
- 1 L Compact Cabinet with 4" base
- 1 plastic laminate top

DIMENSIONS			TYPE OF TOP
W	D	H	PLASTIC LAMINATE
60"	30"	82"	LC3003C

## ASSEMBLY WORKSTATION



LC3001

- 1 double WM bench frame
- 2 plastic bin rails
- 1 vertical adapter for power outlet strip and pneumatic connection
- 1 power outlet strip
- 1 document holder with arm
- 1 utility panel
- 2 panel bracket kits
- 1 tackboard / whiteboard
- 1 overhead LED workstation light
- 1 pair of cantilever overhead supports
- 1 tool rail
- 1 balancer trolley
- 1 tool balancer
- 5 plastic bins
- 1 pack of 10 double back single hooks
- 2 legs, 27"D×32"H
- 1 drawer unit
- 2 compact drawers, 3"H
- 1 plastic laminate top
- 1 stringer

DIMENSIONS			TYPE OF TOP
W	D	H	PLASTIC LAMINATE
60"	30"	82"	LC3001





## REPAIR AND MAINTENANCE WORKSTATION



LC2105L3C

- 1 double WM bench frame
- 1 tiltable shelf
- 1 power outlet module
- 2 partial dividers
- 1 storage cabinet with door
- 1 plastic bin rail
- 3 plastic bins
- 1 tackboard / whiteboard
- 1 panel bracket kit
- 1 leg, 27"D × 32"H
- 1 L compact cabinet with 4" base
- 1 laminated hardwood top
- 1 utility panel
- 1 screwdriver holder
- 1 pliers holder

DIMENSIONS			TYPE OF TOP
W	D	H	LAMINATED HARDWOOD
60"	30"	82"	LC2105L3C

## LABELING WORKSTATION



LC2109L3C

- 1 double WM bench frame
- 1 tiltable shelf
- 1 power outlet module
- 6 plastic bins
- 1 tackboard / whiteboard
- 1 panel bracket kit
- 3 partial dividers
- 1 leg, 27"D × 32"H
- 1 L compact cabinet with 4" base
- 1 laminated hardwood top
- 2 plastic bin rails
- 2 wire spool holders
- 1 pair of cantilever overhead supports
- 1 overhead LED workstation light

DIMENSIONS			TYPE OF TOP
W	D	H	LAMINATED HARDWOOD
60"	30"	82"	LC2109L3C

## DOUBLE WORKSTATION



LC2201L3C

- 1 double WM bench frame
- 2 tiltable shelves
- 2 power outlet modules
- 16 plastic bins
- 4 partial dividers
- 2 legs, 27"D × 32"H
- 2 L compact cabinets with 4" base
- 2 laminated hardwood tops
- 6 plastic bin rails
- 2 wire spool holders
- 2 pairs of cantilever overhead supports
- 2 overhead LED workstation lights
- 1 tackboard / whiteboard
- 1 panel bracket kit
- 2 tool holders
- 2 LCD monitor, keyboard and mouse arm kits

DIMENSIONS			TYPE OF TOP
W	D	H	LAMINATED HARDWOOD
60"	60"	82"	LC2201L3C

# PRECONFIGURED MODELS

## BASIC WORKSTATION WITH R HEAVY-DUTY CABINET



R5WH5-2005

- 1 heavy-duty cabinet (with drawer compartments)
- 1 leg, 27"D×32"H
- 1 laminated hardwood top
- 2 storage cabinets with double integrated doors
- 2 WM brackets for storage cabinet
- 1 double WM bench frame

DIMENSIONS			TYPE OF TOP
W	D	H	LAMINATED HARDWOOD
60"	30"	82"	R5WH5-2005

## ASSEMBLY WORKSTATION WITH R HEAVY-DUTY CABINET



R5WH5-2003

- 1 heavy-duty cabinet (with drawer compartments)
- 1 laminated hardwood top
- 1 leg, 27"D×32"H
- 1 double WM bench frame
- 1 tiltable shelf
- 2 partial dividers
- 1 vertical adapter for power bar and pneumatic connection
- 1 power outlet strip
- 1 steel shelf
- 1 pair of structural shelf supports
- 1 privacy panel
- 1 panel bracket kit
- 1 panel for plastic bins
- 7 plastic bins

DIMENSIONS			TYPE OF TOP
W	D	H	LAMINATED HARDWOOD
60"	30"	82"	R5WH5-2003

## MAINTENANCE WORKSTATION WITH R HEAVY-DUTY CABINETS



R5WL5-2003

- 2 heavy-duty cabinets (with drawer compartments)
- 1 laminated hardwood top
- 2 steel shelves
- 2 adapters for WS50 shelf
- 1 double WM bench frame
- 1 pair of cantileveroverhead supports
- 1 overhead LED workstation light
- 1 tool rail
- 1 balancer trolley
- 1 tool balancer
- 2 plastic bin rails
- 1 tool holder
- 4 plastic bins
- 1 power outlet module
- 1 tiltable pan
- 2 tiltable shelves
- 4 partial dividers
- 2 storage cabinets with door
- 1 document holder with arm
- 1 LCD monitor and keyboard arm

DIMENSIONS			TYPE OF TOP
W	D	H	LAMINATED HARDWOOD
72"	30"	82"	R5WL5-2003

## RISER SHELVES

### PAINTED STEEL SHELF

WS50



- Thickness: 1¼"
- Compatible with all riser shelf supports
- Actual width = nominal width – 3¼"

### LAMINATED HARDWOOD SHELF

WS51



- Made from varnished hardwood slats
- Thickness: 1¼"
- Compatible with WS54, WS55, WS59 and WM27-1202 riser shelf supports
- Attractive appearance

### PLASTIC LAMINATE SHELF

WS52



- Colors: Default is white. Add -BA for black or -GB for gray to the end of the product number
- Thickness: 1¼"
- Compatible with WS54, WS55, WS59 and WM27-1202 riser shelf supports
- Attractive appearance

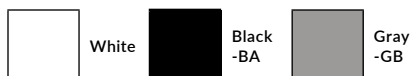

### DISSIPATIVE SHELF

WS53



- Dissipates electrical charges that can damage electronic components
- The resistance point to point and point to ground is between 10<sup>6</sup>Ω and 10<sup>9</sup>Ω
- Color: white
- Thickness: 1¼"
- Compatible with WS54, WS55, WS59 and WM27-1202 riser shelf supports

### STAINLESS STEEL SHELF

WS56



- Thickness: 1¼"
- #4 brushed finish
- Compatible with all riser shelf supports
- Actual width = nominal width – 3¼"

### RESISTANT ACRYLIC / PVC LAMINATE SHELF

WS57



- Color: gray
- Thickness: 1¼"
- Compatible with WS54, WS55, WS59 and WM27-1202 riser shelf supports

NOTE: Grounding accessories are sold separately, [see page 183](#).

#### DIMENSIONS

#### TYPE OF SHELF

W	D	PAINTED STEEL	LAMINATED HARDWOOD*	PLASTIC LAMINATE*	DISSIPATIVE*	STAINLESS STEEL	ACRYLIC / PVC LAMINATE*
48"	12"	WS50-4812	WS51-4812	WS52-4812-__	WS53-4812	WS56-4812	WS57-4812
60"	12"	WS50-6012	WS51-6012	WS52-6012-__	WS53-6012	WS56-6012	WS57-6012
72"	12"	WS50-7212	WS51-7212	WS52-7212-__	WS53-7212	WS56-7212	WS57-7212

NOTE: \* Please check with your Customer Service representative for lead times.

### RISER SHELF SUPPORTS

WS54



- Sold in pairs
- Compatible with WS50 (12"D), WS51, WS52, WS53, WS56 and WS57 shelves
- Height: 16"
- Attractive appearance

PRODUCT NO.	W × D × H
WS54-1602	3½" × 10¼" × 16"

### RISER SHELF SUPPORTS WITH POWER OUTLETS ON BOTH SIDES



WS55



- Sold in pairs
- Each support includes either three 12A outlets for 15A circuit or three 12A outlets for 15A circuit with two USB ports (1 A, 1 C)
- Compatible with WS50 (12"D), WS51, WS53, WS56 and WS57 shelves
- Dimensions: 3½"W × 10 ¼"D × 16"H
- Attractive appearance

PRODUCT NO.	OPTIONS
WS55-161002	3 power outlets (12A)
WS55-161202	3 power outlets (12A), 2 USB ports (1 A, 1 C)

# COMPONENTS – STRUCTURE ABOVE THE WORK SURFACE

## RISER SHELF SUPPORTS WITH POWER OUTLETS ON ONE SIDE



WS59



- Sold in pairs
- One support includes either three 12A outlets for 15A circuit or three 12A outlets for 15A circuit with two USB ports (1 A, 1 C)
- Compatible with WS50 (12"D), WS51, WS53, WS56 and WS57 shelves
- Dimensions: 3½"W × 10 ¼"D × 16"H
- Attractive appearance

PRODUCT NO.	OPTIONS
WS59-161002	3 power outlets (12A)
WS59-161202	3 power outlets (12A), 2 USB ports (1 A, 1 C)

## ECONO RISER SHELF SUPPORTS

WS82



- Sold in pairs
- Can support one or two 12"D shelves
- Compatible with WS50 and WS56 shelves only
- Total height: 16"
- Mid-height shelf: 8"
- Easy to assemble

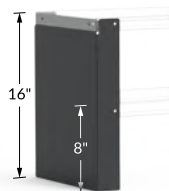

PRODUCT NO.	HEIGHT
WS82-1601	16"



WSC2020

## SHELF BACK OR FRONT STOP

WS58 / WS99



- Painted steel: WS58
- Stainless steel: WS99
- Compatible with WS50, WS51, WS52, WS53, WS56 and WS57 shelves
- Prevents objects from falling from riser shelves
- Extends above shelf by 1"
- To order: Specify the type of steel required: WS58 for painted steel and WS99 for stainless steel
- To order a WS99 in stainless steel, add O1 to the product number for installation at the back of the shelf and O2 for installation at the front

PRODUCT NO.	W × H	FOR SHELF
WS__-48__	45"W × 2¼"H	48" W
WS__-60__	57"W × 2¼"H	60" W
WS__-72__	69"W × 2¼"H	72" W

## BACK PANEL FOR RISER SHELF

WS83 / WS93



- Painted steel: WS83
- Stainless steel: WS93
- Installs behind the work surface and riser shelf
- Compatible with all types of top and shelf
- Includes holes for running cables through
- Height: 20"
- Extends above the riser shelf to prevent objects from falling
- To order: Specify the type of steel required, e.g., WS83-4616 for painted steel

PRODUCT NO.	WIDTH
WS__-4816	48"
WS__-6016	60"
WS__-7216	72"

## LED LIGHT FOR RISER SHELF

WS7A



- Brightens shaded areas under riser shelves
- Emits a brighter light than fluorescent tubes and is more energy efficient
- Color temperature: 6000-7000K (cool)
- Includes a 10' power cord
- Installs under the riser shelf
- Two different galvanized steel adapters available:
  - Adapter O1 for WS51, WS52, WS53 and WS57 shelves
  - Adapter O2 for WS50 and WS56 shelves
- To order: Specify the adapter number required: O1 or O2

PRODUCT NO.	WIDTH	SHELF WIDTH
WS7A-1812__	18"	48"W and over
WS7A-2412__	24"	48"W and over
WS7A-3612__	36"	48"W and over
WS7A-4812__	48"	60"W and over
WS7A-6012__	60"	72"W and over

## WM BENCH FRAME

### MULTI-PURPOSE UPRIGHT

### WM10

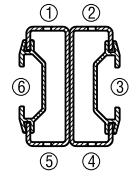
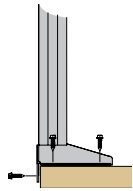

- Compatible with most workbench tops available on the market. Requires a good quality top at least 1½" thick
- Distinctive shape and industry-leading rigidity
- Includes six fixing zones to minimize interference between components
- Perforated on the front and back faces in 1" increments c/c for optimal placement of accessories ①②④⑤
- Includes two black aluminum extrusions on the sides for fine-tuned accessory placement ③⑥
- Five anchor points on the foot provide optimal stability on the two main axes
- Symmetrical front and back so the upright can be used for back-to-back workstations
- The 48"H version is ideal for overhead accessories

PRODUCT NO.	HEIGHT
WM10-24	24"
WM10-36	36"
WM10-48	48"

### WM BENCH FRAME

### WM11

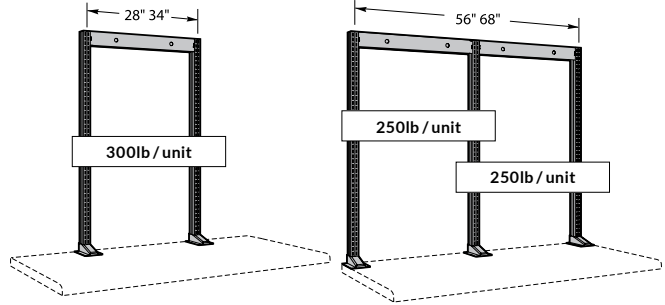

#### The single frame includes:

- 2 WM10 uprights
- 1 WM15 upright crossmember
- Load capacity: 300lb. per unit

PRODUCT NO.	W x H	WIDTH REQUIRED
WM11-2836	28" x 36"	32" min.
WM11-2848	28" x 48"	32" min.
WM11-3436	34" x 36"	38" min.
WM11-3448	34" x 48"	38" min.

#### The double frame includes:

- 3 WM10 uprights
- 2 WM15 upright crossmembers
- Load capacity: 250lb. per unit (500lb. total)

PRODUCT NO.	W x H	WIDTH REQUIRED
WM11-5636	56" x 36"	60" min.
WM11-5648	56" x 48"	60" min.
WM11-6836	68" x 36"	72" min.
WM11-6848	68" x 48"	72" min.

### TOP FLANGE FOR WM11 FRAME – 34" C/C WS1A/WS91



- Painted steel: WS1A
- Stainless steel: WS91
- Designed specifically to be compatible with the 34"W single or double WM frame
- Compatible with all types of top
- Height: 5" Extends above top by approx. 3¼"
- Designed to be centered on the frame
- To order: Specify the type of steel required, e.g., WS1A-480502 for a 34"W top flange for WM frame in painted steel with two uprights

PRODUCT NO.	WIDTH	APPLICATION
WS__-480502	48"	For 2 WM uprights
WS__-600502	60"	For 2 WM uprights
WS__-720502	72"	For 2 WM uprights
WS__-720503	72"	For 3 WM uprights

### UPRIGHT CROSSMEMBER

### WM15



- Strengthens WM frames
- Hooks onto WM10 uprights and can be secured in place
- Includes two knockouts for pneumatic connections

PRODUCT NO.	WIDTH (C/C)
WM15-28	28"
WM15-34	34"
WM15-56	56"
WM15-68	68"

### TOP FLANGE FOR WM11 FRAME – 28" C/C

### WS18/WS98



- Painted steel: WS18
- Stainless steel: WS98
- Designed specifically to be compatible with the 28"W single or double WM bench frame
- Compatible with all types of top
- Height: 5" Extends above top by approx. 3¼"
- Designed to be centered on the frame

- To order: Specify the type of steel required, e.g., WS18-480502 for a 28"W top flange for WM frame in painted steel with two uprights

PRODUCT NO.	WIDTH	APPLICATION
WS__-360502	36"	For 2 WM uprights
WS__-480502	48"	For 2 WM uprights
WS__-600502	60"	For 2 WM uprights
WS__-600503	60"	For 3 WM uprights
WS__-720502	72"	For 2 WM uprights
WS__-720503	72"	For 3 WM uprights

# COMPONENTS – STRUCTURE ABOVE THE WORK SURFACE

## SHELF

WS50 / 51 / 52 / 53 / 56 / 57



- Installs on WM uprights with WM27 riser shelf supports
- 200lb. load capacity
- Compatible with WS58 / WS99 shelf back or front stop
- Thickness: 1¼"

PRODUCT NO.	W x D	TYPE OF SHELF
WS50-6012	56¾" x 12"	Steel
WS51-6012	60" x 12"	Laminated hardwood
WS52-6012	60" x 12"	Plastic laminate
WS53-6012	60" x 12"	Dissipative
WS56-6012	56¾" x 12"	Stainless steel
WS57-6012	60" x 12"	Acrylic / PVC
WS50-7212	68¾" x 12"	Steel
WS51-7212	72" x 12"	Laminated hardwood
WS52-7212	72" x 12"	Plastic laminate
WS53-7212	72" x 12"	Dissipative
WS56-7212	68¾" x 12"	Stainless steel
WS57-7212	72" x 12"	Acrylic / PVC

NOTE: Available colors for WS52:



## TILTABLE SHELF

WM20

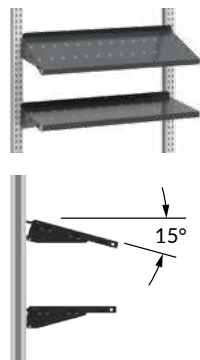

- Hooks onto WM uprights
- Includes slots spaced 2" apart c/c for installing SH52 dividers
- Includes two side brackets which can be placed at right angles or at a 15° angle
- Shelf is reversible and the edge can be used as a back stop or support for plastic bins or, if used with a 12"D shelf, as a support for ring binders
- Load capacity: 100lb. (evenly distributed)

PRODUCT NO.	W x D
WM20-2808	28" x 8"
WM20-2812	28" x 12"
WM20-3408	34" x 8"
WM20-3412	34" x 12"

## TILTABLE PAN

WM22

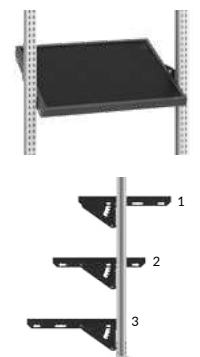

- Hooks onto WM uprights
- Three positions available: front, center or back
- Tilts from 0 to 30° with five easily adjustable positions
- Includes a full-size ribbed mat
- Usable surface area: 24½" x 18½" (28" x 20")
- Usable surface area: 30½" x 18½" (34" x 20")
- 200lb. capacity.

PRODUCT NO.	W x D
WM22-2820	28" x 20"
WM22-3420	34" x 20"

## TOP REINFORCER

WM14

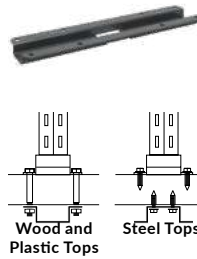

- Required for work tops less than 1½" thick or in poor condition, and for back-to-back workstations
- Strengthens the anchor points of the WM upright
- Secures to the underside of the work surface

PRODUCT NO.	W x D	COLOR
WM14-01	4" x 16"	Black



## STRUCTURAL SHELF SUPPORTS

WM27



- Sold in pairs
- Hooks onto WM uprights
- Compatible with all types of shelf 60"W or 72"W
- Can be installed at a right angle or at a 15° angle

PRODUCT NO.	DEPTH	FOR SHELVES
WM27-1201	12"	WS50, WS56
WM27-1202	12"	WS51, WS52, WS53, WS57

## TOOL HOLDER

WM30

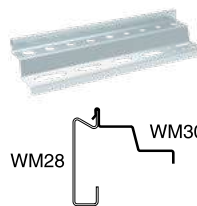

- Galvanized steel
- Installs on WM20 shelves, WM28 plastic bin rails and WM62 monitor trays
- Includes a variety of hole sizes to hang different tools

PRODUCT NO.	WIDTH
WM30-01	12"

## PARTIAL DIVIDER

SH52

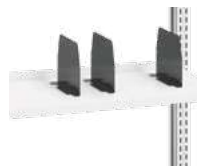

- Unique design
- Compatible with 8"D and 12"D WM20 tiltable shelves; adjustable in 2" increments c/c
- Inserts into the shelf slots, forwards or backwards

PRODUCT NO.	D x H
SH52-1206	8" x 6"

## SLIDING DIVIDER

WS87

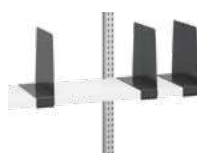

- Clips onto a 12"D WS50 steel shelf installed above or below the work surface
- Not compatible with WS58 shelf backs or front stops

PRODUCT NO.	D x H
WS87-1210	12" x 10"

# COMPONENTS – STRUCTURE ABOVE THE WORK SURFACE

## CANTILEVER OVERHEAD SUPPORTS

WM18



- Sold in pairs
- Hooks onto WM uprights
- Locks in place via a safety latch on the top of the support
- Load capacity: designed to hold a WM43 overhead workstation light and one WM47 tool rail, or two WM47 tool rails

PRODUCT NO.	DEPTH	COLOR
WM18-26	26"	Black

## TOOL RAIL

WM47

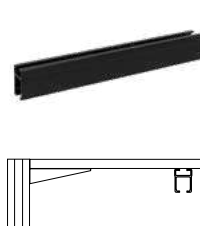

- Holds one or more WM48 balancer trolleys
- Installs on WM18 cantilever overhead supports (sold separately)
- Easily adjustable depth
- Color: black
- Load capacity: 25lb.

PRODUCT NO.	WIDTH	C / C INTERVALS
WM47-4801	48"	28" / 34"
WM47-6001	60"	28" / 34" / 56"
WM47-6002	60"	68"

## OVERHEAD LED WORKSTATION LIGHT

WM43



- Installs on WM18 cantilever overhead supports (sold separately)
- Includes adapter
- Installs on single or double WM frames
- Emits a bright light while being energy efficient
- Color temperature: 6000-7000K (cool)
- Includes a 10' power cord
- To add a motion sensor, add MS to the product number, e.g., WM43-3602MS for an overhead LED workstation light with motion sensor

PRODUCT NO.	WIDTH	UPRIGHT WIDTH
WM43-3602__	36"	28" and 34" c / c
WM43-4801__	48"	28" and 56" c / c
WM43-4802__	48"	34" c / c
WM43-6001__	60"	34", 56" and 68" c / c

## BALANCER TROLLEY

WM48



- Inserts into the WM47 tool rail;
- Color: black;
- Can receive a pneumatic connector.

PRODUCT NO.
WM48-01

## TOOL BALANCER

WM49



- For hanging tools over the work surface
- 6' metal cable with tension adjustment
- Color: black
- Load capacity: 3lb. max.

PRODUCT NO.
WM49-01

## OVERHEAD DOUBLE LED WORKSTATION LIGHT

WM43



- Consists of two Overhead LED Workstation Lights placed side by side
- Installs on WM18 cantilever overhead supports (sold separately)
- Includes adapter
- Installs on single or double WM frames
- Emits a bright light while being energy efficient
- Color temperature: 6000-7000K (cool)
- Includes a 10' power cord
- To add a motion sensor, add MS to the product number, e.g., WM43-3602DMS for an overhead LED workstation light with motion sensor

PRODUCT NO.	WIDTH	UPRIGHT WIDTH
WM43-3602D__	36"	28" and 34" c / c
WM43-4801D__	48"	28" and 56" c / c
WM43-4802D__	48"	34" c / c
WM43-6001D__	60"	34", 56" and 68" c / c



## JOINER FOR TOOL RAIL

WM89

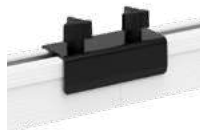

- Connects two WM47 tool rails on two adjacent workstations

PRODUCT NO.
WM89-01

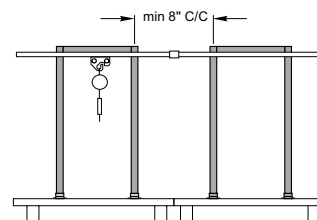

# COMPONENTS – STRUCTURE ABOVE THE WORK SURFACE

## PLASTIC BIN



RG20



- For easier storing, moving and managing of small parts
- Lightweight and durable
- 45° angled rim for easy identification of bin contents and removal of bins
- Compatible with WM55 panels for plastic bins, and WM28 and WM9C plastic rail rails

- 6" plastic bins can be subdivided

DIMENSIONS			PRODUCT NO.		
W	D	H	BIN	PARTITION	DIVIDER
3"	3"	2"	RG20-030302	-	-
4"	3"	2"	RG20-040302	-	-
6"	3"	2"	RG20-060302	RG22-0302	-
6"	6"	2"	RG20-060602	RG22-0602	RG24-0602
3"	3"	3"	RG20-030303	-	-
4"	3"	3"	RG20-040303	-	-
6"	3"	3"	RG20-060303	RG22-0303	-
6"	6"	3"	RG20-060603	RG22-0603	RG24-0603

## PLASTIC BIN RAIL

WM28



- Hooks onto WM uprights; adjustable in 1" increments c/c
- Can be installed at a right angle or angled 15°
- Compatible with most brands of plastic bins (with hanging lip) on the market
- Compatible with all RG20 plastic bin sizes
- 75lb. capacity (evenly distributed weight)

PRODUCT NO.	WIDTH
WM28-2801	28"
WM28-3401	34"

## WIRE SPOOL HOLDER

WM31



- Includes two side brackets and a 3/4" dia. rod
- Load capacity: 50lb.

PRODUCT NO.	WIDTH
WM31-2801	28"
WM31-3401	34"

## VERTICAL ADAPTOR FOR ELECTRICAL AND AIR OUTLETS

WM41



- Installs on the side of WM upright;
- Can receive a power outlet strip or pneumatic connector.

PRODUCT NO.	HEIGHT	COLOR
WM41-01	8"	Black

## LIGHT-DUTY ARM ADAPTER

WM68



- Quick installation on WM10 uprights
- Includes a 1/2" dia. rotating rod for attaching a non-Rousseau lamp or document holder
- Load capacity: 20lb.

PRODUCT NO.	COLOR
WM68-01	Black

## LIGHT-DUTY ARM

WM69



- Attaches to the WM68 light-duty arm adaptor to extend the range of a document holder or lamp pivoting on a 1/2" dia. rod
- Capacity: 20 lb.

PRODUCT NO.	WIDTH	COLOR
WM69-12	14"	Black

## DOCUMENT HOLDER WITH ARM

WM70



- Includes a WM68 arm adapter and a 12"W WM69 arm
- The document holder (14" x 13 1/2") includes a document clip and an edge to support binders
- Load capacity: 20lb.

PRODUCT NO.	COLOR
WM70-01	Black

## PAPER AND CARDBOARD SPOOL HOLDER

WM86

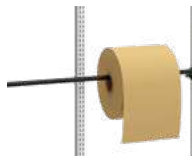

- Installs on WM uprights to create a packaging station
- Includes two end brackets and one rod
- Rod diameter: 1"
- Spool is inserted by pivoting one end of the rod, only one person needed
- Color: black
- 75lb. capacity

PRODUCT NO.	WIDTH
WM86-56	56"
WM86-68	68"

## LAMP WITH MAGNIFIER AND LED LIGHT

70000640



- Clamps onto the work surface (bracket included) or to WM uprights with a WM68-01 adapter, sold separately
- The lamp's reach on the upright can be extended with a WM69-12 arm, sold separately
- Diopter: 5 (2.25x magnification)
- Color: black

PRODUCT NO.
70000640



# COMPONENTS – STRUCTURE ABOVE THE WORK SURFACE

## PRIVACY PANEL

WM52



- Painted steel
- Closes the back of a WM bench frame
- A WM50 bracket kit must be ordered separately (one kit per panel or for back-to-back panel installation)
  - 24"H panels can be installed on 36"H and 48"H uprights
  - 36"H panels must be installed on 48"H uprights only

PRODUCT NO.	W × H
WM52-2424	24" × 24"
WM52-2436	24" × 36"
WM52-3024	30" × 24"
WM52-3036	30" × 36"

BACK-TO-BACK INSTALLATION

NOTES: 24"W panels must be installed on uprights 28" apart c/c  
30"W panels must be installed on uprights 34" apart c/c

## UTILITY PANEL

WM5A

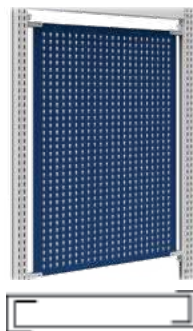

- For hanging accessories and tools
- Painted steel with perforations spaced 1" apart c/c
- Load capacity: 50lb. per panel
- Compatible with WM9F, WM9G, WM9H, WM9S and WM9L light-duty hooks, and WM9A and WM9B heavy-duty hooks
- Compatible with WM9C rails, and WM9D, WM9M, WM9N, WM9P and WM9Q holders
- Compatible with WM21 shelves
- Compatible with most popular hooks and holders on the market
- A WM50 bracket kit must be ordered separately (one kit per panel or per back-to-back panel installation)
  - 24"H panels can be installed on 36"H and 48"H uprights
  - 36"H panels must be installed on 48"H uprights only

PRODUCT NO.	W × H
WM5A-2424	24" × 24"
WM5A-2436	24" × 36"
WM5A-3024	30" × 24"
WM5A-3036	30" × 36"

BACK-TO-BACK INSTALLATION

NOTES: 24"W panels (22 holes) must be installed on uprights 28" apart c/c  
30"W panels (28 holes) must be installed on uprights 34" apart c/c

## PANEL BRACKET KIT

WM50



- Includes four brackets
- Required for installation of WM52, WM5A and WM54 panels
- Easy, tool-free installation on the sides of WM10 uprights

PRODUCT NO.	COLOR
WM50-01	Black

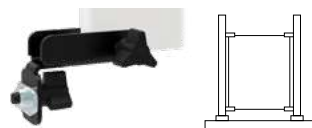

## TACKBOARD / WHITEBOARD

WM54



- Dual-function reversible panel: tack notes to a cork board or write on a lauzonite whiteboard with erasable whiteboard markers
- Panel surface is magnetic
- A WM50 bracket kit must be ordered separately

PRODUCT NO.	W × H	UPRIGHT C/C
WM54-2424	24" × 24"	28"
WM54-3024	30" × 24"	34"

## PANEL FOR PLASTIC BINS (STRUCTURAL)

WM55

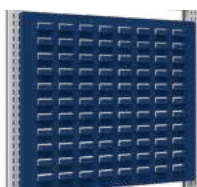

- Painted steel
- Holds RG20 Plastic Bins
- Compatible with most brands of plastic bins (with hanging lip) on the market
- Hooks onto WM uprights

PRODUCT NO.	W × H	UPRIGHTS (H)
WM55-2824	28" × 24"	36" to 48"
WM55-2836	28" × 36"	48"
WM55-3424	34" × 24"	36" to 48"
WM55-3436	34" × 36"	48"

NOTES: 28"W panels must be installed on uprights 28" apart c/c  
34"W panels must be installed on uprights 34" apart c/c

## UTILITY PANEL (STRUCTURAL)

WM59

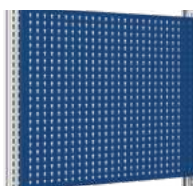

- Painted steel
- Hooks onto WM uprights
- Includes perforations spaced 1" apart c/c for hanging a range of hooks
- Compatible with WM9F, WM9G, WM9H, WM9J and WM9L light-duty hooks, and WM9A and WM9B heavy-duty hooks
- Compatible with WM9C rails, and WM9D, WM9M, WM9N, WM9P and WM9Q holders
- Compatible with WM21 shelves

PRODUCT NO.	W × H	UPRIGHT HEIGHT
WM59-2824	28" × 24"	36" or 48"
WM59-2836	28" × 36"	48"
WM59-3424	34" × 24"	36" or 48"
WM59-3436	34" × 36"	48"

NOTES: 28"W panels (26 holes) must be installed on uprights 28" apart c/c  
34"W panels (32 holes) must be installed on uprights 34" apart c/c

# COMPONENTS – STRUCTURE ABOVE THE WORK SURFACE

## LIGHT DUTY HOOKS

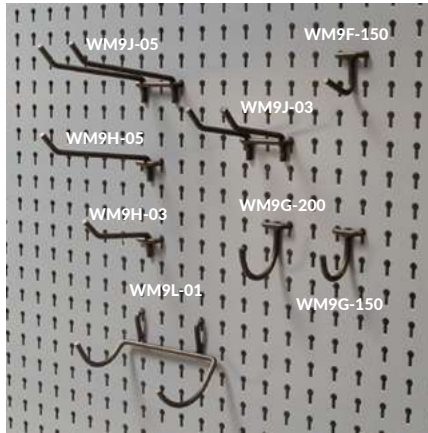

- For storing various types of parts, tools and accessories
- Compatible with all panels currently available on the market (1/4" dia. holes)
- Compatible with WM5A and WM59 utility panels

TYPE / PACKAGE	DIMENSION	PRODUCT NO.
Straight hooks/20	1 1/2"D	WM9F-150
Single hooks/20	1 1/2" dia.	WM9G-150
Single hooks/20	2" dia.	WM9G-200
Double back single hooks/10	3"D	WM9H-03
Double back single hooks/10	5"D	WM9H-05
Double back double hooks/10	3"D	WM9J-03
Double back double hooks/10	5"D	WM9J-05
Drill holder/1	5"W x 3 1/2"D	WM9L-01

NOTES: These hooks and holders are compatible with all perforated panels with 1/4" dia. holes spaced 1" apart c/c. These panels are among the most popular on the market.

## VINYL RUB-ON IDENTIFICATION DECAL WM91

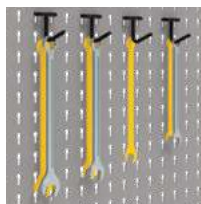

- For easy identification of where tools should be stored on utility panels
- Contrasting color so it is easy to notice when a tool is missing and what kind of tool it is
- Ideal for 5S method tool management
- Sold in rolls of 2'W x 8'L

PRODUCT NO.  
WM91-01J

## SCREWDRIVER HOLDER WM9N



- Hooks onto utility panels (WM5A and WM59)
- Color: black
- Holds 6-12 screwdrivers

PRODUCT NO.	VERSION	W x D x H
WM9N-01	Single	9" x 1 1/2" x 2"
WM9N-02	Double	9" x 3 1/4" x 2"

## PLIERS HOLDER WM9M

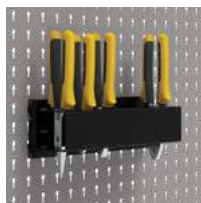

- Hooks onto utility panels (WM5A, WM57 and WM59)
- Color: black
- Holds up to six pliers

PRODUCT NO.                      W x D x H  
WM9M-01                              9" x 2 1/2" x 2"

## POLYCARBONATE PROTECTIVE PANELS

- Protects employees when adequate physical distancing is difficult to maintain
- Made of unbreakable transparent polycarbonate
- Compatible with accessories that attach to the front and back of the post

## PROTECTIVE BACK PANEL WS9A



- Installs on the back of a WM11 frame

PRODUCT NO.	W x H
WS9A-2836	28" x 36"
WS9A-2848	28" x 48"
WS9A-3436	34" x 36"
WS9A-3448	34" x 48"

# COMPONENTS – STRUCTURE ABOVE THE WORK SURFACE

## PROTECTIVE MIDDLE PANEL WS9B



- Installs on the left or right of a WM post
- Installs on the work surface top when the side is inaccessible
- The panel protrudes 24"D beyond the work surface
- Add **L** to the product number for installation on the left, or **R** for installation on the right, e.g., WS9B-3036-24L

PRODUCT NO.	D × H
WS9B-3036-24_	30" × 36"
WS9B-3048-24_	30" × 48"
WS9B-3636-24_	36" × 36"
WS9B-3648-24_	36" × 48"

## PROTECTIVE END PANEL WS9C



- Installs on the left or right of a WM post
- Used when the side of the work surface is accessible
- The panel protrudes 24"D beyond the work surface
- Add **L** to the product number for installation on the left, or **R** for installation on the right, e.g., WS9C-2448-24L

PRODUCT NO.	D × H
WS9C-2436-24_	24" × 36"
WS9C-2448-24_	24" × 48"
WS9C-3036-24_	30" × 36"
WS9C-3048-24_	30" × 48"
WS9C-3636-24_	36" × 36"
WS9C-3648-24_	36" × 48"

## STORAGE CABINETS

### WM STORAGE CABINET WM75



- Hooks onto WM uprights or can be hung under the work surface
- Can be secured to the uprights with tapping screws
- The storage cabinet can be subdivided with a WM20 shelf and SH52-1206 dividers
- Load capacity: 200lb.



PRODUCT NO.	W × D × H	TYPE
WM75-281516	28" × 15" × 16"	Cabinet without door
WM75-281516L3	28" × 15" × 16"	Cabinet with door and lock (2 keys)
WM75-341516	34" × 15" × 16"	Cabinet without door
WM75-341516L3	34" × 15" × 16"	Cabinet with door and lock (2 keys)
WM76-2816L3	28" × 16" door with lock (2 keys)	

#### POSSIBLE CONFIGURATIONS

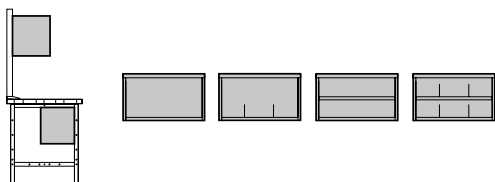

NOTE: Adjustable shelf (WM20) and dividers (SH52) sold separately.

### ADJUSTABLE SHELF RD05



- Includes a back stop to prevent objects from falling to the bottom of the cabinet
- Adjustable in 1" increments c/c
- Load capacity: up to 100lb., evenly distributed
- Compatible with SH52 dividers

PRODUCT NO.	W × D
RD05-2412	24" × 12"
RD05-2712	27" × 12"
RD05-3012	30" × 12"
RD05-3612	36" × 12"

### R CABINET HOUSING RD00

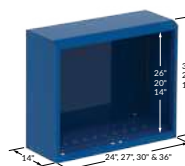

- Specially designed to be anchored to a wall or installed on WM uprights (27"W, 30"W and 36"W) with RD08 adapters
- Compatible with RD05 adjustable shelves, adjustable in 1" increments c/c
- Load capacity: 600lb. (if wall and wall anchoring are of sufficient strength)
- Includes one bottom shelf
- Wall anchoring hardware not included
- Cabinet heights available: 18", 24" and 30"
- RD08 adapters must be ordered to install 27"W, 30"W and 36"W cabinets on WM uprights
- To order: Add the cabinet height required to the product number, e.g., RD00-241424.

PRODUCT NO.	W × D
RD00-2414_	24" × 14"
RD00-2714_	27" × 14"
RD00-3014_	30" × 14"
RD00-3614_	36" × 14"

### ADAPTERS FOR RD00 CABINET RD08



- For installing an RD00 cabinet housing (27"W, 30"W, 36"W) on WM uprights
- Easy installation

PRODUCT NO.	WIDTH
RD08-28	28"
RD08-34	34"

# COMPONENTS – STRUCTURE ABOVE THE WORK SURFACE

## R CABINET



- Can be anchored to a wall or installed on WM uprights (27"W, 30"W and 36"W) with RD08 adapters
- Includes one bottom shelf
- The 30"H cabinet includes an adjustable shelf
- The shelves are compatible with SH52 dividers
- Wall anchoring hardware not included
- Choice of doors. Add one of the following to the product number:
  - 00: Without door
  - 01: Solid integrated door (except R5MEA-18\_\_)
  - 02: Polycarbonate single integrated door (for 24"H housings and over)
  - 03: Solid double integrated doors (for housings 24"H and over, and 30"W and over)
  - 04: Polycarbonate double integrated doors (for housings 24"H and over, and 30"W and over)
  - 11: Flipper door (for 18"H housings only)

### WIDTH×DEPTH

HEIGHT	24"×14"	27"×14"	30"×14"	36"×14"
18"	R5MCA-18__	R5MPA-18__	R5MDA-18__	R5MEA-18__
24"	R5MCA-24__	R5MPA-24__	R5MDA-24__	R5MEA-24__
30"	R5MCA-30__	R5MPA-30__	R5MDA-30__	R5MEA-30__

## SINGLE INTEGRATED DOOR FOR RD00 HOUSING

RD12 / RD13



- Integrated door: RD12
- Polycarbonate integrated door: RD13
- Compatible with RD05 adjustable shelves
- Opens 180° for full access to items stored inside
- Door widths available: 24", 27", 30" and 36"
- Three types of lock available: for a standard central lock, LP for a safety hasp or L50 for an electronic lock
- To order: Specify the type & width of the door and lock required, e.g., RD12-2414\_\_.

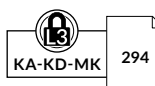

PRODUCT NO.	HEIGHT	
RD12-__14__	14"	Except 36"
RD__-__20__	20"	
RD__-__26__	26"	

## FLIPPER DOOR FOR RD00 HOUSING

RD20



- Full-width handle provides a comfortable grip
- For 18"H wall cabinet housings only
- Two types of lock available: L3 for a standard central lock or L50 for an electronic lock
- To order an econo lock-in system, add B to the product number
- Compatible with RD05 adjustable shelves (must be factory installed)
- To order: Specify the type of lock required, e.g., RD20-2414L50

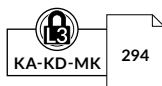

PRODUCT NO.	W×H
RD20-2414__	24"×14"
RD20-2714__	27"×14"
RD20-3014__	30"×14"
RD20-3614__	36"×14"

## DOUBLE INTEGRATED DOORS FOR RD00 HOUSING

RD17 / RD18



- Integrated door: RD17
- Polycarbonate integrated door: RD18
- Compatible with RD05 adjustable shelves
- Opens 180° for full access to items stored inside
- Three types of lock available: L3 for a standard central lock, LP for a safety hasp or L50 for an electronic lock
- To order: Specify the type of door and lock required, e.g., RD18-3020L3



PRODUCT NO.	W×H
RD__-3020__	30"×20"
RD__-3026__	30"×26"
RD__-3620__	36"×20"
RD__-3626__	36"×26"

## LED LIGHT FOR WM CABINET

WM44



- For installation underneath a WM75 cabinet
- Emits a brighter light than fluorescent tubes and is more energy efficient
- Color temperature: 6000-7000 K (cold)

PRODUCT NO.	WIDTH
WM44-2801	28"
WM44-3401	34"

## ELECTRONICS COMPONENTS

### POWER OUTLET STRIP



- 15A power outlet strip with circuit breaker
- Mounts horizontally under a work surface or riser shelf
- Order a WM41 adapter (sold separately) for installation on WM uprights, [see page 166](#)

PRODUCT NO.	LENGTH	EXTENSION CORD	NO. OF OUTLETS
70000500	9"	6'	5, without on/off switch
70000505	12"	6'	6, with on/off switch
70000506	12"	15'	6, with on/off switch

### GROUNDING CORD

WS89



- Connects a shelf or dissipative top to a grounding block or directly to the ground
- Dissipates electrical charges that can damage electronic components
- Length: 10'

PRODUCT NO.	
70000300	Grounds a workstation 1MΩ resistance
WS89-01	Connects all components on the workstation to a common grounding point

### GROUNDING WRIST STRAP

70000320



- Made of stretch fabric
- 6' cable
- Dissipates electrical charges that can damage electronic components
- 1MΩ resistance

PRODUCT NO.	
70000320	

### POWER OUTLET CHANNEL



WM40



- Hooks easily onto WM uprights
- Each power outlet channel includes either three 12A outlets for 15A circuit, or three 12A outlets for 15A circuit with two USB ports (1 A, 1 C)
- Both versions include two knockouts for pneumatic connections
- To order: Specify the channel length required: 28" or 34"

PRODUCT NO.	OPTIONS
WM40-__0000	Finishing channel without perforations
WM40-__1001	3 power outlets (12A), 2 knockouts for pneumatic connections
WM40-__1101	3 power outlets (12A), 2 knockouts for pneumatic connections, 1 plate
WM40-__1201	3 power outlets (12A), 2 USB ports (1 A, 1 C), 2 knockouts for pneumatic connections
WM40-__1301	3 power outlets (12A), 2 USB ports (1 A, 1 C), 2 knockouts for pneumatic connections, 1 plate

### GROUNDING BLOCK

70000350



- Two jacks to connect grounding wrist straps
- Includes a 10' grounding cord
- Dissipates electrical charges that can damage electronic components

PRODUCT NO.	
70000350	

### CONDUCTIVE PLASTIC BIN



RG21



- Dissipates electrical charges that can damage electronic components
- Color: black
- For easier storing, moving and managing of small parts
- Lightweight and durable
- Compatible with WM55 panels for plastic bins, WM28 plastic bin rails and all 3"H and 4"H drawers
- 45° angled rim for easy identification of bin contents and removal of bins
- 6" plastic bins can be subdivided

DIMENSIONS			PRODUCT NO.		
W	D	H	BIN	PARTITION	DIVIDER
3"	3"	2"	RG21-030302	-	-
4"	3"	2"	RG21-040302	-	-
6"	3"	2"	RG21-060302	RG23-0302	-
6"	6"	2"	RG21-060602	RG23-0602	RG25-0602
3"	3"	3"	RG21-030303	-	-
4"	3"	3"	RG21-040303	-	-
6"	3"	3"	RG21-060303	RG23-0303	-
6"	6"	3"	RG21-060603	RG23-0603	RG25-0603



Creates a secure, organized and personalized workspace.



Easy and tool-free reconfiguration allows your workstation to evolve in line with your needs.

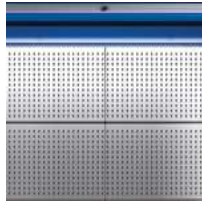

Spacious and well-lit workspace.



Door opens and closes easily, smoothly and securely.



INDEX	PAGE(S)
<b>TekZone Workstation Hutch</b>	<b>172</b>
Preconfigured Models . . .	173-174
Step by Step . . . . .	175-177
Accessories . . . . .	178-179

## TEKZONE WORKSTATION HUTCH

With the TekZone workstation hutch, you can create a personalized and organized workspace.

The work area it provides is spacious and well lit. Each TekZone Hutch is equipped with an LED light with motion sensor so the workspace lights up as soon as you open the door.

A wide range of accessories helps you to stay tidy by freeing up the work surface, while keeping your essential tools close at hand.

The ingenious door mechanism allows you to open and close the hutch easily, smoothly and securely. With the full-width handle, you can open the door with any hand position. The door is fitted with a lock to protect the contents of the hutch.

The TekZone Hutch installs on heavy-duty cabinets, Rousseau workstations and most other workstations on the market. Treat yourself to a unique solution!



## TEKZONE MOBILE WORKCENTER

PRODUCT NO.	W×D×H
TZ-C002X*	60" × 27" × 77½"
1 Multi-drawer mobile cabinet	R5GKG-3018
1 Thin stainless steel top	RH11-6027
1 Hutch with painted steel utility panels, LED light with motion sensor, 1 painted steel power feed panel with 3 power outlets (12A) and 2 USB ports (1 A, 1 C)	TZ-JKG40U2002P
1 Battery charger shelf	RH54-26
1 Electronic tablet arm	WM06-62-01
2 Half width shelves	RH60-2412
2 Partial dividers	SH52-1206
1 Plastic bin rail	WM9C-12

## 60"W HUTCH

PRODUCT NO.	W×D×H
TZ-JKG40U2104P	60" × 27" × 40"
1 Hutch with painted steel utility panels, LED light with motion sensor, 1 painted steel power feed panel with 3 power outlets (12A) and 2 USB ports (1 A, 1 C)	TZ-JKG40U2002P
1 Battery charger shelf	RH54-26
1 Electronic tablet arm	WM06-62-01
2 Half width shelves	RH60-2412
2 Partial dividers	SH52-1206
1 Plastic bin rail	WM9C-12

NOTE: \*The hutch is factory assembled on the cabinet with this model.



## TEKZONE WORKCENTER

PRODUCT NO.	W×D×H
TZ-C040S*	48" × 30" × 76"
1 Multi-drawer cabinet with 4"H base	R5KHG-3030S
1 Pre-punched stainless steel top	RC35-4830-02
1 Hutch with stainless steel utility panels, LED light with motion sensor, 1 stainless steel power feed panel with 3 power outlets (12A), 2 USB ports (1 A, 1 C), knockout and perforation	TZ-JHG40U3002S
1 Electronic tablet arm	WM06-62-01
2 Half width shelves	RH60-2412
3 Partial dividers	SH52-1206
1 Can holder	WM9D-12
1 Wire spool and roll holders	WM9P-1201

## 48"W HUTCH

PRODUCT NO.	W×D×H
TZ-JHG40U3104S	48" × 27" × 40"
1 Hutch with stainless steel utility panels, LED light with motion sensor, 1 stainless steel power feed panel with 3 power outlets (12A), 2 USB ports (1 A, 1 C), knockout and perforation	TZ-JHG40U3002S
1 Electronic tablet arm	WM06-62-01
2 Half width shelves	RH60-2412
3 Partial dividers	SH52-1206
1 Can holder	WM9D-12
1 Wire spool and roll holder	WM9P-1201

NOTE: \*The hutch is factory assembled on the cabinet with this model.

# PRECONFIGURED MODELS



## TEKZONE CONSULTATION STATION

PRODUCT NO.	W×D×H
TZ-C010P*	36" × 27" × 80"
1 Heavy-duty cabinet with 4" base	R5AEE-3414P
1 Pre-punched painted steel top	RC37-3627-02
1 Hutch with painted steel utility panels, LED light with motion sensor, 1 painted steel power feed panel with 3 power outlets (12A) and 2 USB ports (1 A, 1 C)	TZ-JEE40X2002P
1 Monitor mount	RH52-15
1 Keyboard tray	RH53-25
1 Can holder	WM9D-09

## 36"W HUTCH

PRODUCT NO.	W×D×H
TZ-JEE40X2102P	36" × 24" × 40"
1 Hutch with painted steel utility panels, LED light with motion sensor, 1 painted steel power feed panel with 3 power outlets (12A) and 2 USB ports (1 A, 1 C)	TZ-JEE40X2002P
1 Monitor mount	RH52-15
1 Keyboard tray	RH53-25
1 Can holder	WM9D-09

NOTE: \*The hutch is factory assembled on the cabinet with this model.



## TEKZONE WORKSTATION

PRODUCT NO.	W×D×H
TZ-C018PW	60" × 30" × 74"
1 Desk with closed legs and pre-punched wood top, 1 power outlet (12A) and 2 USB ports (1 A, 1 C)	WSA2090
1 Hutch with painted steel utility panels, LED light with motion sensor, 1 L50 lock	TZ-UKH40U002PL50
1 Painted steel power feed panel with 3 power outlets (12A) and 2 USB ports (1 A, 1 C)	TZ-M060T2P
1 Battery charger shelf	RH54-26
1 Half width shelf	RH60-3008
1 Wire spool and roll holders	WM9P-2601
1 Laptop arm	WM06-42
1 Can holder	WM9D-09
1 Plastic bin rail	WM9C-09
1 Tool rail	RH47-6001
1 Balancer trolley	WM48-01
1 Tool balancer	WM49-01

## 60"W HUTCH

PRODUCT NO.	W×D×H
TZ-JKG40U2104P	60" × 27" × 40"
1 Hutch with painted steel utility panels, LED light with motion sensor, 1 L50 lock	TZ-UKH40U002PL50
1 Painted steel power feed panel with 3 power outlets (12A) and 2 USB ports (1 A, 1 C)	TZ-M060T2P
1 Battery charger shelf	RH54-26
1 Half width shelf	RH60-3008
1 Wire spool and roll holders	WM9P-2601
1 Laptop arm	WM06-42
1 Can holder	WM9D-09
1 Plastic bin rail	WM9C-09
1 Tool rail	RH47-6001
1 Balancer trolley	WM48-01
1 Tool balancer	WM49-01



## 4 EASY STEPS

You can quickly and easily configure your own layout in just four steps.

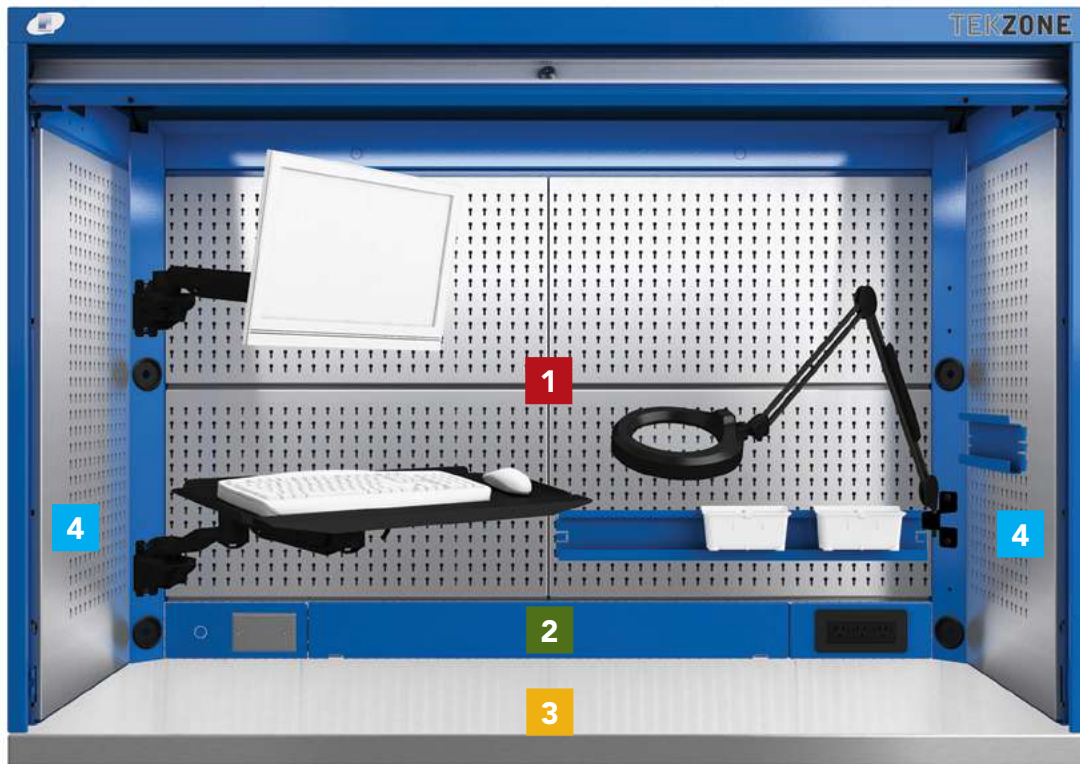

### STEP 1: CHOOSE PANELS

Choose the panels you want in the hutch: panels for plastic bins, utility panels or finishing panels. To ensure your TekZone hutch remains bright, you can choose between stainless steel or painted steel panels. For painted steel panels, we recommend choosing one of the following five paint colors:

White 616	Frost White 061	Light Gray 071	Beige 041	Modern Gray 745

### STEP 2: CHOOSE POWER FEED PANEL

Then you choose a power feed panel from the following five models:

PRODUCT NO.	DESCRIPTION
TZ-M0_ _ 00 _	Cover panel, no outlets
TZ-M0_ _ T1 _	3 power outlets (12A), knockout and perforation
TZ-M0_ _ T2 _	3 power outlets (12A), 2 USB ports (1 A, 1 C)
TZ-M0_ _ T3 _	3 power outlets (12A), 2 USB ports (1 A, 1 C), knockout and perforation
TZ-M0_ _ T4 _	3 power outlets (12A)

### STEP 3: CHOOSE TOP

In this step you choose which type of work surface best meets your needs:

HEIGHT	TOPS FOR R CABINETS				
	PAINTED STEEL	STAINLESS STEEL	LAMINATED HARDWOOD	NITRILE 3/16"	NEOPRENE 1/8"
1 3/4"	RC37	RC35	WS14	-	-
Thin	RH10	RH11	-	-	-
Mat	-	-	-	RH91	RH90

HEIGHT	TOPS FOR R WORKSTATIONS				
	PAINTED STEEL	STAINLESS STEEL	LAMINATED HARDWOOD	NITRILE 3/16"	NEOPRENE 1/8"
1 3/4"	RC37	RC35	WS14	-	-
Mat	-	-	-	RH91	RH90

HEIGHT	TOPS FOR WS WORKSTATIONS				
	PAINTED STEEL	STAINLESS STEEL	LAMINATED HARDWOOD	NITRILE 3/16"	NEOPRENE 1/8"
1 3/4"	WS10	WS12	WS14	-	-
Mat	-	-	-	RH91	RH90

NOTE: The TekZone Hutch must be installed on a work surface.

### STEP 4: ACCESSORIES

Finally, you can equip the hutch with accessories of your choice.



**1** DIMENSIONS AND PANEL TYPES

**UTILITY PANELS**

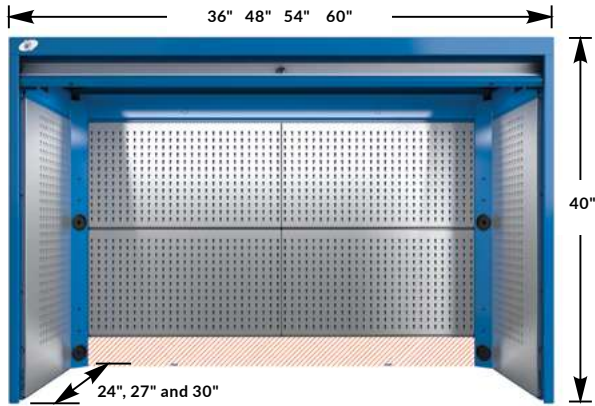

**SPECIFY THE WIDTH AND DEPTH REQUIRED AND THE PANEL FINISH**

Width: 36" = E, 48" = H, 54" = J, 60" = K

Lock: L3, L50

Depth: 24" = E, 27" = G, 30" = H

Panel Finish: Painted steel = P, Stainless steel = S

**TZ-U 40U002**

**UTILITY AND PLASTIC BINS PANELS**

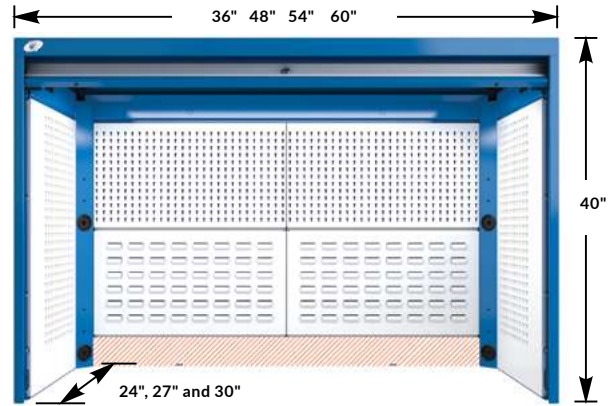

**SPECIFY THE WIDTH AND DEPTH REQUIRED**

Width: 36" = E, 48" = H, 54" = J, 60" = K

Lock: L3, L50

Depth: 24" = E, 27" = G, 30" = H

Panel Finish: Painted steel = P

**TZ-U 40X002P**

**UTILITY AND FINISHING PANELS**

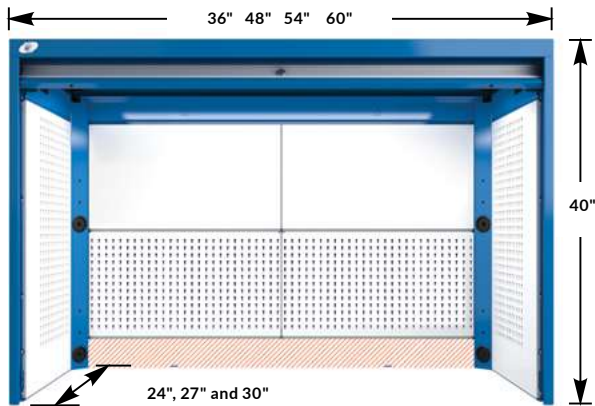

**SPECIFY THE WIDTH AND DEPTH REQUIRED AND THE PANEL FINISH**

Width: 36" = E, 48" = H, 54" = J, 60" = K

Lock: L3, L50

Depth: 24" = E, 27" = G, 30" = H

Panel Finish: Painted steel = P, Stainless steel = S

**TZ-U 40X004**

**BACK PANELS LOGIC**

36" wide: Two full-width 15" high panels

48", 54" and 60" wide: Four half-width 15" high panels

**BACK AND SIDE PANELS CAPACITY**

Panel capacity: 100lb per panel

**2** POWER FEED PANEL

- The power feed panels include a 10' power cord
- The center panel can be used to manage power and network cables

**SPECIFY THE WIDTH AND FINISH REQUIRED**

Width: 36" = 36, 48" = 48, 54" = 54, 60" = 60

Panel Finish: Painted steel = P, Stainless steel = S

**TZ-M0 T4**



**FINISHING PANEL NO OUTLETS**



### 3 POWER OUTLETS (12A), KNOCKOUT AND PERFORATION



TZ-M0\_T1\_

### 3 POWER OUTLETS (12A), 2 USB PORTS (1 A, 1 C), KNOCKOUT AND PERFORATION



TZ-M0\_T3\_

### 3 POWER OUTLETS (12A) AND 2 USB PORTS (1 A, 1 C)



TZ-M0\_T2\_

### 3 POWER OUTLETS (12A)



TZ-M0\_T4\_

## 3 CHOICE OF TOP

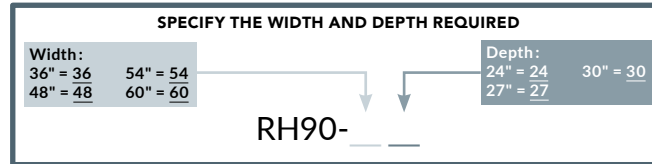

### THIN PAINTED STEEL TOP



RH10- \_ \_ \_ For R cabinets

### 1 3/4" PAINTED STEEL TOP\*



RC37- \_ \_ \_-02 For R cabinets or R workstations  
WS10- \_ \_ \_-02 For WS workstations

### 1 3/4" LAMINATED HARDWOOD TOP\*



WS14- \_ \_ \_-02 For R cabinets, R workstations or WS workstations

### THIN STAINLESS STEEL TOP



RH11- \_ \_ \_ For R cabinets

### 1 3/4" STAINLESS STEEL TOP\*



RC35- \_ \_ \_-02 For R cabinets or R workstations  
WS12- \_ \_ \_-02 For WS workstations

### PROTECTIVE MAT\*\*



RH90- \_ \_ \_ 3/16" Oil resistant nitrile  
RH91- \_ \_ \_ 1/8" Neoprene

NOTES: \* These tops are pre-punched for easy installation of the TekZone Hutch.

\*\*Top to be ordered separately.

The TekZone Hutch must be installed on a work surface.

## 4 ACCESSORIES

### CAN HOLDER

### WM9D



- Ideal for storing cans and other containers of different sizes
- Compatible with side and back panels
- 3"D and 4"H

PRODUCT NO.	WIDTH	COMPATIBILITY
WM9D-09	9"	24" D
WM9D-12	12"	27" D
WM9D-15	15"	30" D

### BATTERY CHARGER SHELF

### RH54



- Hooks onto back utility panels at the desired height
- 25" usable width accommodates several chargers at once
- Includes a non-slip protective mat
- Includes a built-in power bar with six power outlets (15A / 120V, with switch, circuit breaker and 15' power cord)
- Includes storage space for cable management

PRODUCT NO.	WIDTH
RH54-26	26"

# ACCESSORIES

## SLOPED TOP

### RH89



- Keeps the workspace clean and safe while reducing clutter
- 8"H

PRODUCT NO.	W x D
RH89-362408	36" x 24"
RH89-362708	36" x 27"
RH89-363008	36" x 30"
RH89-482408	48" x 24"
RH89-482708	48" x 27"
RH89-483008	48" x 30"
RH89-542408	54" x 24"
RH89-542708	54" x 27"
RH89-543008	54" x 30"
RH89-602408	60" x 24"
RH89-602708	60" x 27"
RH89-603008	60" x 30"

## PLASTIC BIN RAIL

### WM9C



- Plastic bins hook onto the rail for efficient storage of small parts
- Compatible with RG20 plastic bins (sold separately)

PRODUCT NO.	WIDTH	USE
WM9C-09	9"	for 24"D side panels
WM9C-12	12"	for 27"D side panels
WM9C-15	15"	for 30"D side panels
WM9C-20	20"	for half-width back panels on a 48"W hutch
WM9C-23	23"	for half-width back panels on a 54"W hutch
WM9C-26	26"	for half-width back panels on a 60"W hutch
		for full-width back panels on a 36"W hutch

## WIRE SPOOL AND ROLL HOLDERS

### WM9P



- Ideal for wire spools or paper towel rolls
- Tube diameter: 3/4"
- Load capacity: 50lb.

PRODUCT NO.	WIDTH	USE
WM9P-0901	9"	for 24"D side panels
WM9P-1201	12"	for 27"D side panels
WM9P-1501	15"	for 30"D side panels
WM9P-2001	20"	for half-width back panels on a 48"W hutch
WM9P-2301	23"	for half-width back panels on a 54"W hutch
WM9P-2601	26"	for half-width back panels on a 60"W hutch
		for full-width back panels on a 36"W hutch

## SHELF AND DIVIDER

### RH60 / RH61

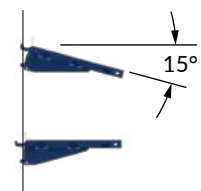

- Hooks onto back utility panels at the desired height
- Can be installed at a right angle or angled 15°
- The shelf is reversible and its edge can act as a back stop for plastic bins and ring binders
- Load capacity: 100lb. (evenly distributed)
- Compatible with SH52-1206 dividers in 2" increments c/c
- Width compatibility:
  - 36"W hutches: full-width shelf
  - 48"W, 54"W and 60"W hutches: half-width shelf
- Add 08 to the product number for an 8"D shelf and 12 for a 12"D shelf.

PRODUCT NO.	WIDTH	COMPATIBILITY
RH60-24__	20"	Half-width shelf for 48"W hutch
RH60-27__	23"	Half-width shelf for 54"W hutch
RH60-30__	26"	Half-width shelf for 60"W hutch
RH61-36__	29"	Full-width shelf for 36"W hutch
SH52-1206		Divider

## TABLET ARM

### WM06

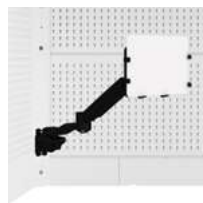

- Compatible with most tablets on the market
- The clamps and mount have a non-slip surface to keep the tablet stable
- The articulating arm with two joints provides extra adjustment options
- Tablet can be rotated and tilted
- Compatible tablet sizes:
  - Small: 7 7/8"W to 10"W
  - Large: 9 7/8"W to 12 1/4"W

PRODUCT NO.	TABLET SIZE
WM06-62-01	Small
WM06-62-02	Large

## LCD MONITOR ARM AND KEYBOARD & MOUSE ARM WM06



- Keyboard tray's usable area: 23 3/8"W x 8 1/2"D
- Includes an articulating arm with a single joint and an articulating arm with two joints providing extra adjustment options
- Compatible with most LCD monitors (max. 21") on the market
- Complies with VESA 75 and 100 monitor mounting standards
- Screen and tray can be rotated and tilted

PRODUCT NO.	VERSION
WM06-22	Complete Kit
WM06-02	LCD Monitor Arm
WM06-32	Keyboard & Mouse Arm

## MONITOR MOUNT

RH52



- Supports a monitor compliant with the VESA 75 and 100 standards
- Includes a central cutout for cable management from the rear of the mount
- Two positions: vertical or angled 10° forward to reduce reflections
- Compatible with utility panels and finishing panels only

PRODUCT NO.  
RH52-15

## KEYBOARD TRAY

RH53

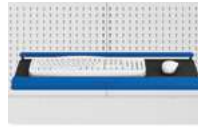

- Unique and heavy-duty design with palm rests
- 25"W to accommodate a keyboard and mouse
- Includes a non-slip protective mat

PRODUCT NO.  
RH53-25

## TOOL RAIL

RH47



- Holds one or more WM48 balancer trolleys
- Color: black
- 25lb. load capacity
- For 48"W, 54"W and 60"W hutches

PRODUCT NO.	WIDTH
RH47-4801	48"
RH47-5401	54"
RH47-6001	60"

## BALANCER TROLLEY

WM48



- Inserts into a RH47 tool rail
- Color: black
- Holds a pneumatic connection

PRODUCT NO.  
WM48-01

## TOOL BALANCER

WM49



- For hanging tools over the work surface
- 6' metal cable with tension adjustment
- Color: black
- Load capacity: 3lb. max.

PRODUCT NO.  
WM49-01

## ELECTRONIC LOCK SYSTEM

L50



- Electronically locks the slide-up door
- No key required
- Up to 20 different users can be programmed
- 4- to 8-digit access codes
- Simplifies access management
- To order, specify the lock in the model by L50. For a replacement lock, see page 295



PRODUCT NO.  
RH06-WW40L50

## LAPTOP ARM

WM06

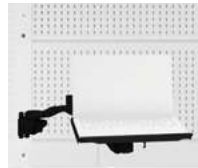

- Tray's usable area: 14"W x 12"D and it can be rotated and tilted
- Includes an articulating arm with two joints providing extra adjustment options

PRODUCT NO.  
WM06-42

## INTERMEDIATE SHELF AND BOTTOM SHELF

RH64 / RH65

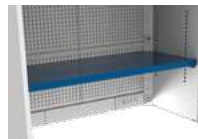

- Full-length and full-depth shelf
- 200 lb. load capacity (evenly distributed weight)
- Compatible with SH52-2106 dividers in 3" increments c / c
- RH64 Intermediate Shelf:
  - Attaches to RH35 side panels only
  - Compatible with RH20 and RH21 back utility panels; the area next to the shelf will be unusable
  - To add to a preconfigured TZ model, replace side panels with RH35 side panels
  - Not compatible with RH22 and RH23 back panels for plastic bins
  - Not compatible with the following side panels: RH32 panels for plastic bins, RH30 and RH31 utility panels and RH28 and RH29 finishing panels
- RH65 Bottom Shelf:
  - A top (see page 177) is required for joining the hutch to the cabinet underneath

PRODUCT NO.	WIDTH
RH__-3627	36"
RH__-4827	48"
RH__-5457	54"
RH__-6027	60"

NOTE: RH36 to RH41 power feed and cable management panels cannot be used with the bottom shelf.

## LAMP WITH MAGNIFIER AND LED LIGHT



- Diopter: 5 (2.25x magnification)
- Installs on the back uprights with an RH50 lamp support

PRODUCT NO.	USE
RH50-01	Lamp support
70000640	Lamp with magnifier and LED light

# R SPECIALIZED WORKCENTER



Wide range of accessories for building a highly personalized workcenter layout.

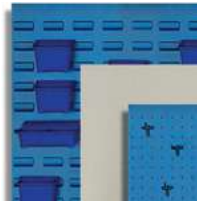

Plastic bin panels, utility panels and finishing panels are all available for maximum flexibility.



Many accessories can be simply hooked in place.



Ergonomic and retractable keyboard tray.

## R SPECIALIZED WORKCENTER



R5XHG-4010

With the R Specialized Workcenter, you can keep a wide variety of accessories within easy reach, from the simplest tools to a computer with LCD monitor. Accessories can be swapped in and out and moved easily with simple tools or none at all. You can easily change and expand your workcenter to suit your needs. Our products stand out for their superior quality, design and attention to detail. For example, all screws are hidden from view, so the finish and overall appearance is refined and aesthetically attractive. To select your cabinet and top, see the R Heavy-Duty Cabinet section ([see page 4](#)).

## TECH UPRIGHT

RD44



- For installation of an RD02 storage cabinet, R5MCA computer cabinet, RC47 panel supports, RC60 and RC61 power feed panels and RC62 and RC63 cover panels
- Anchors securely to the work surface
- Installs on RC35, RC37, WS08, WS14 and WS16 tops only

PRODUCT NO.	HEIGHT
RD44-19	19"
RD44-40	40"

NOTE: The top needs an extra 1½" at the back.

## COVER PANEL

RC62 / RC63



- Painted steel: RC62
- Stainless steel: RC63
- Can be combined with a power feed panel or used on its own to cover the feet of tech uprights for a neater appearance
- 4"H
- Suitable for use with RD44 tech uprights only

PRODUCT NO.	WIDTH
RC__-2401	24"
RC__-3001	30"
RC__-3601	36"
RC__-4801	48"

## PANEL SUPPORTS

RC47



- Supports RC41 and RC42 finishing panels, RC93 and RC94 utility panels and RC45 plastic bin panels
- Enables a combination of different panel types to be installed
- For 19"H tech uprights: add 03 to the product number
- For 40"H tech uprights: add 01 to the product number for the lower section and 02 for the upper section

PRODUCT NO.	WIDTH
RC47-24__	24"
RC47-30__	30"
RC47-36__	36"
RC47-48__	48"
RC47-60__	60"

## POWER FEED PANEL



RC60 / RC61



- Painted steel: RC60
- Stainless steel: RC61
- Includes a power bar with three 12A outlets for a 15A circuit
- Three additional versions available: with a knockout for a pneumatic connection and a perforation (with a cover plate) for a telephone / Ethernet jack; or with two USB ports (1 A, 1 C); or with knockout, perforation and two USB ports
- Suitable for use with RD44 tech uprights only
- Can be combined with a cover panel or used on its own to cover the feet of tech uprights for a neater appearance
- To order: Specify the panel width required: 30", 36", 48" or 60"

PRODUCT NO.	OPTIONS
RC__-__1001	3 power outlets (12A)
RC__-__1101	3 power outlets (12A), perforations
RC__-__1201	3 power outlets (12A), 2 USB ports (1 A, 1 C)
RC__-__1301	3 power outlets (12A), 2 USB ports (1 A, 1 C), perforations

## FLIPPER DOOR STORAGE CABINET



- Flipper door has a large handle for a comfortable grip
- Compatible with RD45 LED lights
- Can be wall mounted or installed on RD44 tech uprights
- The back is removable when wall mounted allowing easy access to electrical components (power outlets)
- Includes a standard lock



PRODUCT NO.	W × D × H
R5MCB-2111	24" × 14" × 21"
R5MDB-2111	30" × 14" × 21"
R5MEB-2111	36" × 14" × 21"
R5MGB-2111	48" × 14" × 21"
R5MKB-2111	60" × 14" × 21"

## SLIDING DOOR STORAGE CABINET

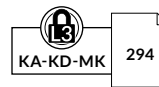

- The integrated door provides maximum clearance for handling items stored in the cabinet
- Compatible with RD45 LED lights
- To order: Add 07 for a solid integrated door or 08 for a polycarbonate integrated door
- Can be wall mounted or installed on RD44 tech uprights
- The back is removable when wall mounted allowing easy access to electrical components (power outlets)
- Includes a standard lock

PRODUCT NO.	W × D × H
R5MEB-21__	36" × 14" × 21"
R5MGB-21__	48" × 14" × 21"
R5MKB-21__	60" × 14" × 21"

## COMPUTER CABINET



- Includes a monitor mount to create room for a CPU and LCD monitor
- Add 5 to the product number for standalone use (with fan) or 6 for use with sloped top (without fan).
- Cabinet dimensions: 24"W x 14"D x 21"H
- Polycarbonate window dimensions: 18<sup>7</sup>/<sub>8</sub>"W x 14<sup>1</sup>/<sub>8</sub>"H
- Keyboard tray's usable area: 22<sup>1</sup>/<sub>2</sub>"W x 14<sup>1</sup>/<sub>2</sub>"D



PRODUCT NO.	TYPE
R5MCA-24_0	Cabinet only
R5MCA-24_1	Cabinet with polycarbonate door
R5MCA-24_2	Cabinet with keyboard and mouse tray
R5MCA-24_3	Cabinet with polycarbonate door, and keyboard and mouse tray

## LED LIGHT

RD45



- Brightens shaded areas under cabinets
- Can be installed under storage cabinets
- Brighter and more energy efficient than a fluorescent tube
- Color temperature: 6000-7000K (cool)
- Includes a galvanized steel adapter
- Includes a 10' power cord

PRODUCT NO.	CABINET WIDTH
RD45-1814	24"
RD45-2414	30", 36"
RD45-3614	48", 24"+24"
RD45-4814	60", 30"+30"
RD45-6014	36"+36"

NOTE: Not compatible with R5MCA computer cabinets.

## SLOPED TOP FOR STORAGE CABINET AND COMPUTER CABINET

RD42



- Keeps the workspace clean and safe while reducing clutter
- Fits perfectly into the "5S" storage method
- 35° sloped top for computer cabinet and storage cabinet
- The top for computer cabinets includes a fan
- 8"H

PRODUCT NO.	TYPE OF TOP	W x D
RD42-241408	For storage cabinet	24" x 14"
RD42-301408	For storage cabinet	30" x 14"
RD42-361408	For storage cabinet	36" x 14"
RD42-481408	For storage cabinet	48" x 14"
RD42-601408	For storage cabinet	60" x 14"
RD43-241408	For computer cabinet	24" x 14"

## FINISHING PANEL

RC41 / RC42



- Painted steel: RC41
- Stainless steel: RC42
- Creates a neat and attractive appearance
- Top panel can be replaced with a storage cabinet
- Two panels can be stacked (15"H + 20"H) to create a full height wall
- To order: Add 15 to the product number for a lower panel and 20 for an upper panel

PRODUCT NO.	WIDTH
RC__-24__	24"
RC__-30__	30"
RC__-36__	36"
RC__-48__	48"

## UTILITY PANEL

RC93 / RC94

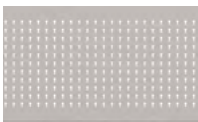
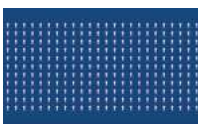

- Painted steel: RC93
- Stainless steel: RC94
- Includes perforations spaced 1" apart c/c and is compatible with all WM9\_ hooks and holders, [see pages 214-215](#)
- Top panel can be replaced with a storage cabinet
- Two panels can be stacked (15"H + 20"H) to create a full height wall
- To order: Add 15 to the product number for a lower panel and 20 for an upper panel

PRODUCT NO.	WIDTH	NO. OF HOLES
RC__-24__	24"	24
RC__-30__	30"	30
RC__-36__	36"	36
RC__-48__	48"	48

NOTE: Not compatible with the WM21 Tilttable Shelf for Utility Panel.

## PLASTIC BIN PANEL

RC45



- Available in painted steel only
- Compatible with RG20 plastic bins and all brands of plastic bins with hanging lip on the market
- Top panel can be replaced with a storage cabinet
- Two panels can be stacked (15"H + 20"H) to create a full height wall
- To order: Add 15 to the product number for a lower panel and 20 for an upper panel

PRODUCT NO.	WIDTH
RC45-24__	24"
RC45-30__	30"
RC45-36__	36"
RC45-48__	48"



## MULTI-PURPOSE HOLDER

RC51



- Holds up to four aerosol cans
- Also compatible with drinks cans
- Hooks securely onto RC41, RC42, RC93, RC94 and RC45 panels
- Installs all along the width of the workstation, just above the lower finishing panel
- Model ending in 12 is designed to be installed under a storage cabinet

PRODUCT NO.	W × D × H
RC51-120303	12" × 3" × 3"
RC51-120312	12" × 3" × 12"



## LCD MONITOR MOUNT

RC52



- Supports monitors with a 75mm or 100mm c/c mounting hole pattern (VESA 75 / 100 standard) on RC41, RC42, RC93, RC94 and RC45 panels
- Includes a central cutout for cable management from the rear of the mount
- Two positions: vertical or angled 10° forward to reduce reflections

PRODUCT NO.
RC52-20

## KEYBOARD & MOUSE TRAY

RC53



- 24"W × 12"D usable surface for a keyboard and mouse
- Includes a series of bends at the front (¾" surface) for wrist support
- Hooks securely onto RC41, RC42, RC93, RC94 and RC45 panels
- Installs all along the width of the workstation, just above the lower finishing panel
- Model ending in 02 is designed to be installed under a storage cabinet

PRODUCT NO.
RC53-2412
RC53-241202

## MULTI-PURPOSE SUPPORT

RC54



- Can be used to hold different accessories (laptop, phone, etc.) measuring max. 14"W × 12"D
- Includes a clip to keep documents in place
- Includes a series of bends at the front (¾" surface) for wrist support
- Hooks securely onto RC41, RC42, RC93, RC94 and RC45 panels
- Installs all along the width of the workstation, just above the lower finishing panel
- Model ending in 02 is designed to be installed under a storage cabinet

PRODUCT NO.
RC54-1412
RC54-141202



R5XHG-4005



R5XHH-4008S



R5XUH-4004S

# CORNER WORKSTATION



## CORNER WORKSTATIONS

Corner workstations allow for a more complete and integrated layout. They also make use of all available space for work and storage.

To order, choose "WITH" or "WITHOUT" cabinet under the work surface. Then configure your workstation. Options vary depending on the configuration chosen.

### DISTINCTIVE FEATURES

- Ergonomic 36" or 40" work surface height
- Standard 30" work surface depth
- Choice of two configurations: with or without cabinet under the work surface
- Leveling glides included in each model for a stable and level workstation
- Designed to be placed against a wall or back to back
- Must be anchored to two cabinets of the same height and depth, one on each side (LA30, RA30 or RA35). See the Cabinet section (see page 4) or R Multi-Drawer Cabinet section (see page 66)

### WITHOUT CABINET UNDER THE WORK SURFACE

0030

Right-angled corner  
(2"W finishing panel)

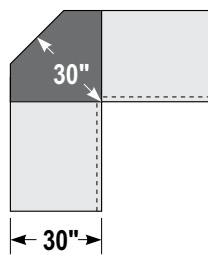

0630

9"W finishing panel

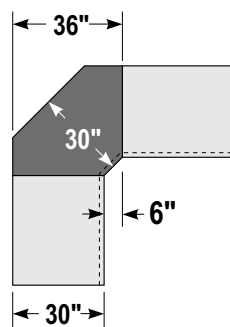

### WITH CABINET UNDER THE WORK SURFACE

1230

L cabinet

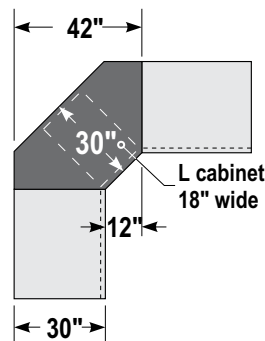

1830

R cabinet

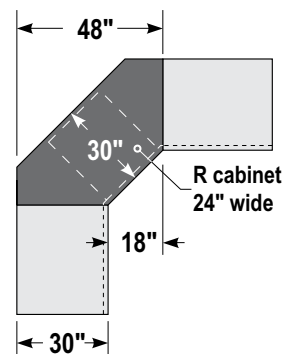

RS-C084X



RS-C002X



RS-C080S



RS-C008X

## 0030 WORKSTATION WITH FINISHING PANELS AND UTILITY PANELS



RS-C090X

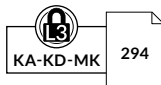

PRODUCT NO.	D OF TOP×H
RS-C090X	30"×76"

### MIDDLE SECTION - CORNER STATION

- 1 Set of painted steel top finishing panels (20"H) and stainless steel power feed panel with 3 power outlets (12A)  
RS-U0030F54S

---

- 1 Set of painted steel lower utility panels (15"H)  
RS-M0030P1P

---

- 1 Pre-punched stainless steel top with attachment bars  
RS-W003001S

---

- 1 Painted steel finishing panel and 4"H stainless steel kick plate  
RS-B0030341001S

### SIDE SECTIONS AND ACCESSORIES

- 2 Workstations with L Compact Cabinets on 4"H stainless steel bases, painted steel upper finishing panels (20"H) and lower utility panels (15"H), stainless steel top and cover panel  
L3XEG-3012L3X2

---

- 3 Packs of 10 double back single hooks (5"D)  
WM9H-05

---

- 1 Pliers holder  
WM9M-01

---

- 4 Leveling glide kits for L Compact Cabinets  
RA75-01

## 0630 WORKSTATION WITH ELECTRONIC TABLET SUPPORT



RS-C050S

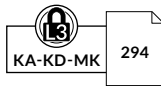

PRODUCT NO.	D OF TOP×H
RS-C050S	30"×36"

### MIDDLE SECTION - CORNER STATION

- 1 Stainless steel cover panel for computer mount  
RS69-063001

---

- 1 Pre-punched stainless steel top with attachment bars  
RS-W063001S

---

- 1 Open leg on leveling glides, painted steel finishing panel and 4"H stainless steel kick plate  
RS-B0630341001S

### SIDE SECTIONS AND ACCESSORIES

- 2 Stainless steel cover panels  
RC67-3601

---

- 2 Stainless steel cabinet tops  
RC35-3630

---

- 2 R Heavy-Duty Cabinets on 4"H stainless steel bases  
R5AEG-3026S

---

- 2 Leveling glide kits for R Heavy-Duty Cabinets  
RA74-01

---

- 1 Tablet arm  
RC59-62-01

## 1230 WORKSTATION WITH STORAGE CABINETS



RS-C060X

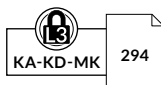

PRODUCT NO.	D OF TOP×H
RS-C060X	30"×76"

### MIDDLE SECTION - CORNER STATION

- 1 Storage cabinet with integrated sliding polycarbonate doors and painted steel power feed panel with 3 power outlets (12A), knockout for pneumatic connection and perforation for telephone or network jack  
RS-U1230R21P

---

- 1 Set of painted steel lower finishing panels (15"H)  
RS-M1230F1P

---

- 1 Pre-punched stainless steel top with attachment bars  
RS-W123001S

---

- 1 L Compact Cabinet with 4"H stainless steel base, leveling glides and finishing panels  
RS-B1230341L02S

### SIDE SECTIONS AND ACCESSORIES

- 2 Workstations with a R Heavy-Duty Cabinets on 4"H stainless steel bases, storage cabinets with integrated sliding polycarbonate doors, LED light, painted steel lower finishing panel (15"H), painted steel cover panel and stainless steel top  
R5XEG-4022X

---

- 2 Leveling glide kits for R Heavy-Duty Cabinets  
RA74-01

---

- 1 LED light for the corner storage cabinet  
RD45-2416

# PRECONFIGURED MODELS

## 1830 WORKSTATION WITH STORAGE CABINETS



RS-C024S

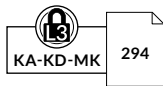

PRODUCT NO.	D OF TOP×H
RS-C024S	30"×76"

### MIDDLE SECTION - CORNER STATION

- 1 Storage cabinet with flipper door and painted steel power feed panel with 3 power outlets (12A), knockout for pneumatic connection and perforation for telephone or network jack

RS-U1830R01S

- 1 Set of stainless steel lower utility panels (15"H)

RS-M1830F1S

- 1 Pre-punched stainless steel top with attachment bars

RS-W183001S

- 1 R Heavy-Duty Cabinet with 4"H stainless steel base, leveling glides and finishing panels

RS-B1830341R02S

### SIDE SECTIONS AND ACCESSORIES

- 2 R Heavy-Duty cabinets on 4"H stainless steel bases, storage cabinets with flipper doors, LED light, stainless steel lower utility panel (15"H), stainless steel top and cover panel

R5XEG-4014S

- 2 Leveling glide kits for R Heavy-Duty Cabinets

RA74-01

- 1 LED light for the corner storage cabinet

RD45-3616

- 1 Multi-purpose holder

RC51-120312

- 1 Pliers holder

WM9M-01

- 1 Single screwdriver holder

WM9N-01

- 1 Pack of 10 double back single hooks (5"D)

WM9H-05

- 1 Pack of 10 double back double hooks (5"D)

WM9J-05

## 1830 WORKSTATION WITH PANELS AND ACCESSORIES



RS-C018X

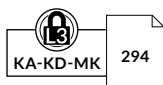

PRODUCT NO.	D OF TOP×H
RS-C018X	30"×76"

### MIDDLE SECTION - CORNER STATION

- 1 Set of painted steel upper finishing panels (20"H) and painted steel power feed panel with 3 power outlets (12A), knockout for pneumatic connection and perforation for telephone or network jack

RS-U1830F11P

- 1 Set of painted steel lower mixed panels (utility and for plastic bins) (15"H)

RS-M1830X1P

- 1 Pre-punched stainless steel top with attachment bars

RS-W183001S

- 1 open leg and leveling glides

RS-B1830341000P

### SIDE SECTIONS AND ACCESSORIES

- 1 R Heavy-Duty Cabinet on 4"H painted steel base, upper finishing panel (20"H), lower utility panel (15"H), painted steel cover panel and stainless steel top

R5XEG-4008X

- 1 R Heavy-Duty Cabinet on 4"H painted steel base, upper finishing panel (20"H), lower panel for plastic bins (15"H), painted steel cover panel and stainless steel top

R5XEG-4010X

- 2 Leveling glide kits for R Heavy-Duty Cabinets

RA74-01

- 1 Pliers holder

WM9M-01

- 2 Packs of 10 double back single hooks (5"D)

WM9H-05

- 14 Plastic bins

RG20-060603

## CORNER WORKSTATIONS - 0030



### 1 TYPE OF SURFACE

#### CHOOSE YOUR WORKSURFACE

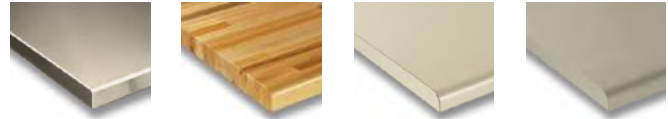

Painted (P) or  
Stainless Steel (S)

Laminated  
Hardwood

Plastic  
Laminate

Acrylic/PVC  
Laminate

RS-W003001\_

RS-W003002

RS-W003003

RS-W003009

Tops are pre-drilled for easy installation of components above the work surface.

### 2 UNDER THE WORKSURFACE

#### CHOOSE YOUR WORKSTATION HEIGHT AND A FINISH FOR THE BASE

Height:\*  
34" or 38"

Base:  
Painted steel = P  
Stainless steel = S

RS-B0030\_1001\_

e.g., RS-B0030341001S for a 34" high 0030 corner workstation with stainless steel base.

NOTE: \*Includes the 4"H base but excludes the 2"H top

### 3 OVER THE WORKSURFACE

#### CHOOSE FROM THE FOLLOWING MODELS

Choose a finish for the power feed and finishing panel: painted steel (P) or stainless steel (S).

**A**

Upper finishing panels + power feed panel\*

RS-U0030F14\_

For this model, the power feed panel determines the panel finish, P or S.

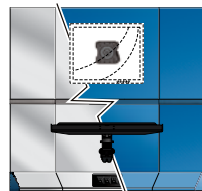

Finishing panels + LCD monitor arm and keyboard & mouse tray + power feed panel\*

RS-M0030S1404\_

For this model, the power feed panel determines the panel finish, P or S.

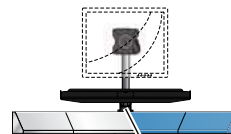

Cover panel + LCD monitor arm and keyboard & mouse tray

RS-M0030T3\_



Power feed panel\*

RS-M0030T4\_

NOTE: \* Includes three 12A power outlets

### 4 CENTER - LOWER PANELS

Choose your panels for model **A** and finish: painted steel (P) or stainless steel (S)



Finishing panels

RS-M0030F1\_



Utility panels

RS-M0030U1\_



Plastic bin panels

RS-M0030L1P



Finishing panels + tablet arm

RS-M0030S2\_

# STEP BY STEP

## CORNER WORKSTATIONS - 0630



### 1 TYPE OF SURFACE

#### CHOOSE YOUR WORKSURFACE

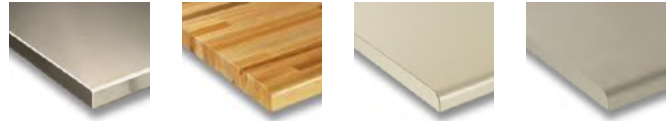

Painted (P) or  
Stainless Steel (S)  
RS-W063001\_

Laminated  
Hardwood  
RS-W063002

Plastic  
Laminate  
RS-W063003

Acrylic/PVC  
Laminate  
RS-W063009

Tops are pre-punched for easy installation of components above the work surface

### 2 UNDER THE WORKSURFACE

#### CHOOSE YOUR WORKSTATION HEIGHT AND A FINISH FOR THE BASE

Height:\*  
34" or 38"

Base:  
Painted steel = P  
Stainless steel = S

RS-B0630\_1001\_

e.g., RS-B0630341001S for a 34" high 0630 corner workstation with stainless steel base.

NOTE: \*Includes the 4"H base but excludes the 2"H top

### 3 OVER THE WORKSURFACE

#### CHOOSE FROM THE FOLLOWING MODELS

Choose a finish for the power feed and finishing panel: painted steel (P) or stainless steel (S).

<p><b>A</b></p>	<p><b>B</b></p>	<p><b>C</b></p>
<p>Storage cabinet with flipper door + power feed panel<sup>2</sup> RS-U0630R01_</p>	<p>Computer cabinet + cover panel RS-U0630C10_</p>	<p>Upper finishing panels + power feed panel<sup>2</sup> RS-U0630F11_ For this model, the power feed panel determines the panel finish, P or S.</p>



Finishing panels + LCD monitor arm and keyboard & mouse tray + power feed panel<sup>1 2</sup>

RS-M0630S1401\_

In this model the power feed panel determines the panel finish, P or S.

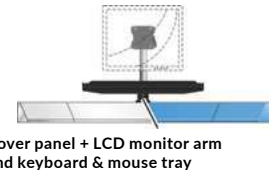

Cover panel + LCD monitor arm and keyboard & mouse tray

RS-M0630T3\_



Power feed panel<sup>2</sup>

RS-M0630T1\_

NOTES: <sup>1</sup>The computer mount is positioned on the right by default in this model.

<sup>2</sup>Includes three 12A power outlets, a knockout for a pneumatic connection and a perforation for installing a telephone or Ethernet jack.

### 4 CENTER - LOWER PANELS

Choose your panels for models **A**, **B** and **C** and finish: painted steel (P) or stainless steel (S).



Finishing panels  
RS-M0630F1\_

Utility panels  
RS-M0630U1\_

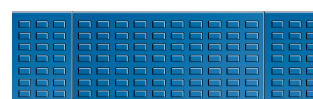

Plastic bin panels  
RS-M0630L1P



Finishing panels + tablet arm<sup>3</sup>  
RS-M0630S2\_

NOTE: <sup>3</sup>The tablet arm is positioned on the right by default in this model.

## CORNER WORKSTATIONS - 1230



### 1 TYPE OF SURFACE

#### CHOOSE YOUR WORKSURFACE

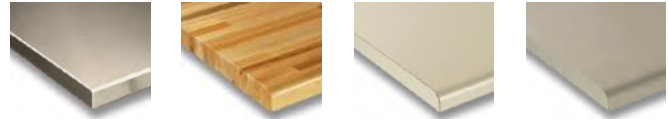

Painted (P) or  
Stainless Steel (S)  
RS-W123001\_

Laminated  
Hardwood  
RS-W123002

Plastic  
Laminate  
RS-W123003

Acrylic/PVC  
Laminate  
RS-W123009

Tops are pre-punched for easy installation of components above the work surface

### 2 UNDER THE WORKSURFACE

Cabinet models include a central locking system (L3) and finishing panels. Cabinet dimensions are 18"W x 27"D x 34"H or 38"H.

NOTES: Drawer compartments are included in all models, see page 27.  
To order drawers without compartments, replace the last two digits of the model number with the next even number up.  
e.g., L01 with, L02 without

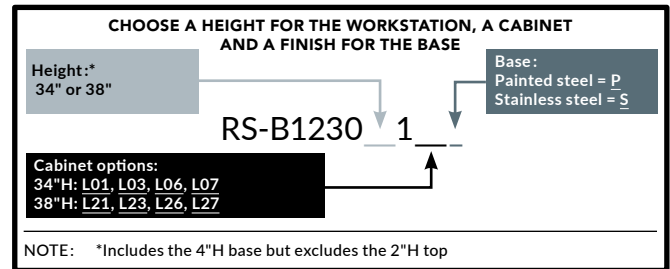

#### 34\"/>



#### 38\"/>



### 3 OVER THE WORKSURFACE

#### CHOOSE FROM THE FOLLOWING MODELS

Choose a finish for the power feed and finishing panel: painted steel (P) or stainless steel (S).

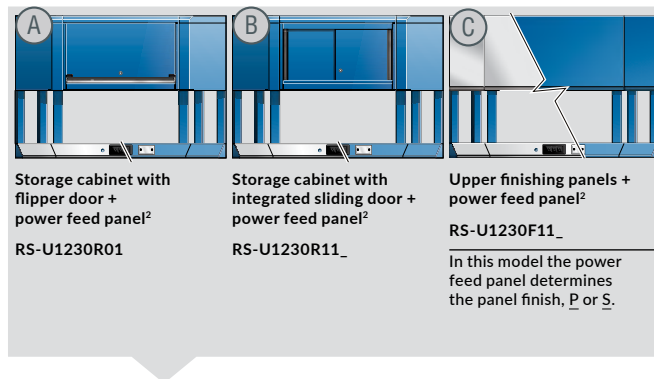

Storage cabinet with  
flipper door +  
power feed panel<sup>2</sup>  
RS-U1230R01

Storage cabinet with  
integrated sliding door +  
power feed panel<sup>2</sup>  
RS-U1230R11\_

Upper finishing panels +  
power feed panel<sup>2</sup>  
RS-U1230F11\_  
In this model the power  
feed panel determines  
the panel finish, P or S.

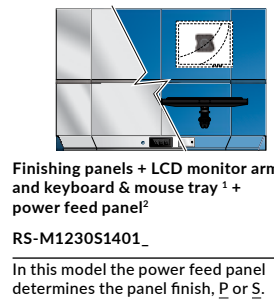

Finishing panels + LCD monitor arm  
and keyboard & mouse tray<sup>1</sup> +  
power feed panel<sup>2</sup>  
RS-M1230S1401\_

In this model the power feed panel  
determines the panel finish, P or S.

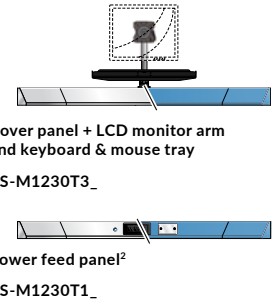

Cover panel + LCD monitor arm  
and keyboard & mouse tray  
RS-M1230T3\_

Power feed panel<sup>2</sup>  
RS-M1230T1\_

NOTES: <sup>1</sup>The computer mount is positioned on the right by default in this model.  
<sup>2</sup>Includes three 12A power outlets, a knockout for a pneumatic connection and a perforation for installing a telephone or Ethernet jack.

### 4 CENTER – LOWER PANELS

Choose your panels for models (A), (B) and (C) and panel finish: painted steel (P) or stainless steel (S).

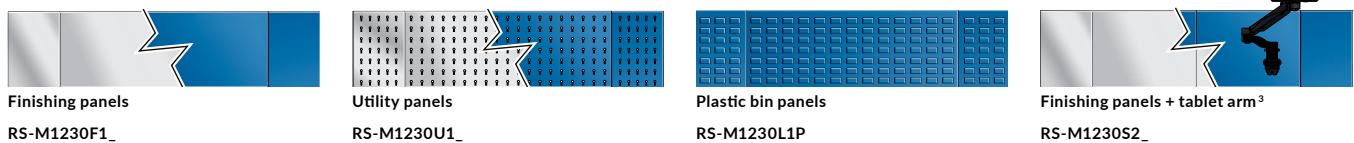

Finishing panels  
RS-M1230F1\_

Utility panels  
RS-M1230U1\_

Plastic bin panels  
RS-M1230L1P

Finishing panels + tablet arm<sup>3</sup>  
RS-M1230S2\_

NOTE: <sup>3</sup>The tablet arm is positioned on the right by default in this model.

# STEP BY STEP

## CORNER WORKSTATIONS - 1830



### 1 TYPE OF SURFACE

#### CHOOSE YOUR WORKSURFACE

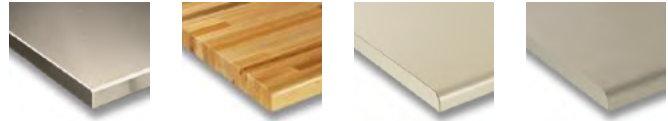

Painted (P) or Stainless Steel (S) RS-W183001_	Laminated Hardwood RS-W183002	Plastic Laminate RS-W183003	Acrylic/PVC Laminate RS-W183009
--	-------------------------------------	-----------------------------------	---------------------------------------

Tops are pre-punched for easy installation of components above the work surface

### 2 UNDER THE WORKSURFACE

Cabinet models include a central locking system (L3) and finishing panels. Cabinet dimensions are 24"W x 27"D x 34"H or 38"H.

NOTES: Drawer compartments are included in all models, see page 6.  
To order drawers without compartments, replace the last two digits of the model number with the next even number up.  
e.g., R01 with, R02 without

**CHOOSE A HEIGHT FOR THE WORKSTATION, A CABINET AND A FINISH FOR THE BASE**

Height: \*  
34" or 38"

**RS-B1830** 1

Base:  
Painted steel = P  
Stainless steel = S

**Cabinet options:**  
34"H: R01, R03, R06, R07, R09, R11  
38"H: R21, R23, R26, R27, R29, R31

NOTE: \*Includes the 4"H base but excludes the 2"H top

#### 34" H CABINETS



#### 38" H CABINETS



### 3 OVER THE WORKSURFACE

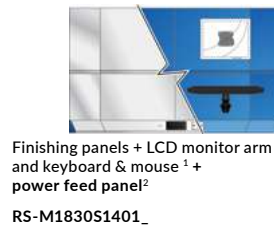
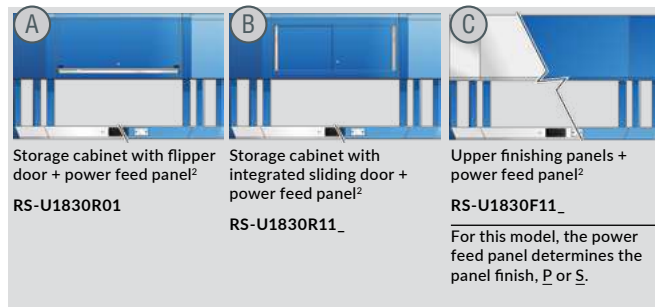

In this model the power feed panel determines the panel finish, P or S.

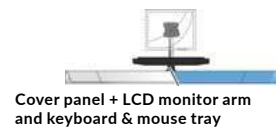

NOTE: For ordering guidelines, (P), (S) and notes 1 & 2, please see page 188.

### 4 CENTER - LOWER PANELS

Choose your panels for models (A), (B) or (C) and panel finish: painted steel (P) or stainless steel (S).

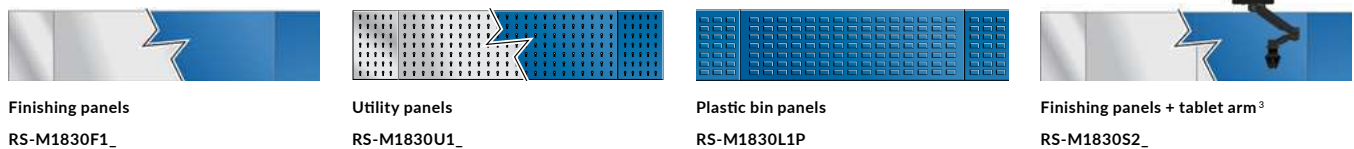

NOTE: <sup>3</sup> The tablet arm is positioned on the right by default in this model.



## CORNER WORKSTATION ACCESSORIES

### MULTI-PURPOSE HOLDER RC51



- Holds up to four aerosol cans
- Also compatible with drinks cans

PRODUCT NO.	FOR
RC51-120312	With or without top cabinet
RC51-120303	With panel configurations only

### DOCUMENT HOLDER RC54



- Includes a clip to keep documents in place

PRODUCT NO.	FOR
RC54-141202	With or without top cabinet
RC54-1412	With panel configurations only

### TABLET ARM RC58



- Compatible with most tablets on the market
- Installs on the lower section (15) of a finishing panel for computer mount (RS81 and RS82)
- The small version is compatible with tablets between 7 $\frac{7}{8}$ "W and 10"W
- The large version is compatible with tablets between 9 $\frac{7}{8}$ "W and 12 $\frac{1}{4}$ "W

PRODUCT NO.	
RC58-62-01	Small
RC58-62-02	Large

### SLOPED TOP RS31



- Keeps the workspace clean and safe while reducing clutter
- The top for computer cabinets includes a fan

PRODUCT NO.	CONFIGURATION	FOR
RS31-063008	0630	Storage cabinet
RS31-123008	1230	Storage cabinet
RS31-183008	1830	Storage cabinet
RS32-063008	0630	Computer cabinet

### LED LIGHT RD45



- Brighter and more energy efficient than a fluorescent tube
- Brightens shaded areas under cabinets
- Color temperature: 6000-7000K (cool)
- Includes a galvanized steel fitting
- Includes a 10' power cord
- The recommended operating temperature for our LED lights is between 5°C and 40°C (41-104°F)

PRODUCT NO.	CONFIGURATION
RD45-2416	0630 and 1230
RD45-3616	1830

### TOOL HOLDERS



- Variety of hooks and holders available for hanging items and tools, [see pages 214-215](#). Here are our most popular items:

PRODUCT NO.	
WM9N-01	Single screwdriver rack
WM9H-05	Double back single hook
WM9M-01	Pliers holder
WM9G-200	2" dia. single loop hook

NOTE: Not compatible with computer cabinets.

## TAKE INSPIRATION FROM THE ALPHABET!

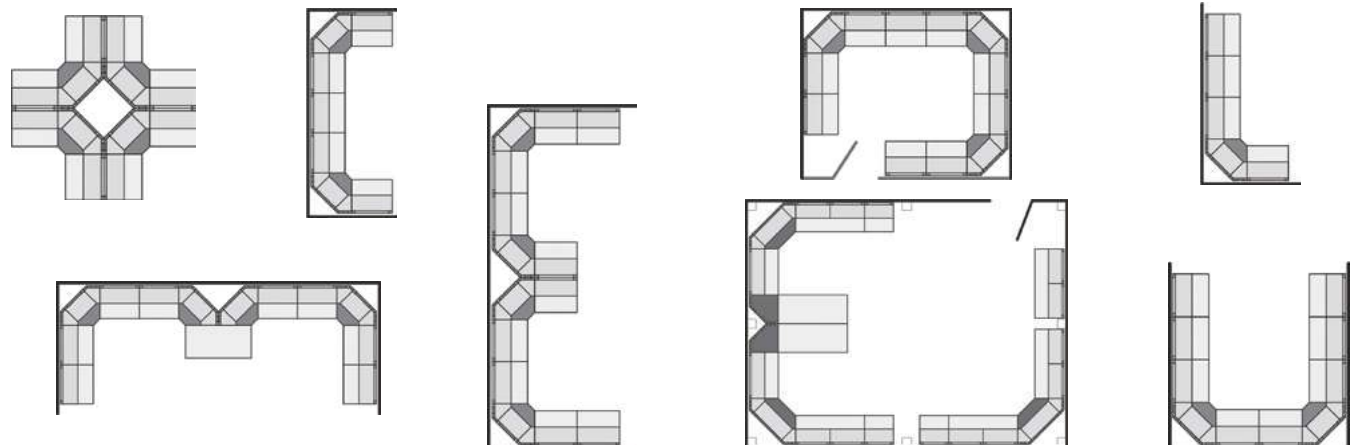



INDEX	PAGE(S)
<u>The MultiTek Cart</u>	192-195
Preconfigured Models . . . . .	196-204
Accessories . . . . .	205-207

## MULTITEK CART

The MultiTek Cart is an ergonomic and multifunctional cart. In an innovative leap forward from standard cart solutions, not only does it transport tools, parts and other items, it also functions as a small portable workstation.

Many configurations are possible, ranging from minimalist to fully equipped. A wide range of accessories can be installed, so you can keep your tools organized and always on hand in your own personalized and mobile workstation.

Cart models with drawers include a lock-in mechanism and those with a cover have a standard lock. PVC liners are also available as optional accessories.

Heavy-duty and maneuverable, the MultiTek Cart is the ideal companion to help you perform your daily tasks.



**LIFETIME WARRANTY**  
The Rousseau drawer rolling mechanism is covered by a lifetime warranty.



REGISTERED INDUSTRIAL DESIGN



2018 WINNER  
**EUROPEAN PRODUCT DESIGN AWARD**

THE ROUSSEAU DIFFERENCE

**LOCKABLE COVER**  
Opens 90° for unrestricted access to the shelf

**COMFORTABLE AND ERGONOMIC HANDLES**

**ROLL-OUT SHELF**  
Expand your work surface area by adding a roll-out shelf

**FRONT OR SIDE DRAWERS (4"H)**  
Transport tools safely and securely. Each drawer includes a lock-in mechanism to keep it closed and has a 50lb. load capacity

**SUPERIOR-QUALITY CASTERS**

**FINISHING PANELS, UTILITY PANELS OR PLASTIC BIN PANELS**  
Add accessories to ensure everything you need is always within reach

**UPRIGHT BUMPERS**  
Protect your work environment from accidental bumps

GENERAL DIMENSIONS

CARTS WITH 3" H CASTERS

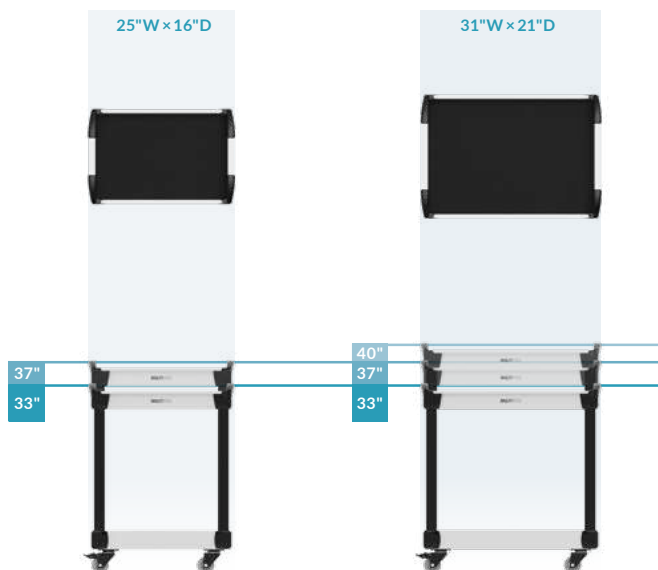

CARTS WITH 5" H CASTERS

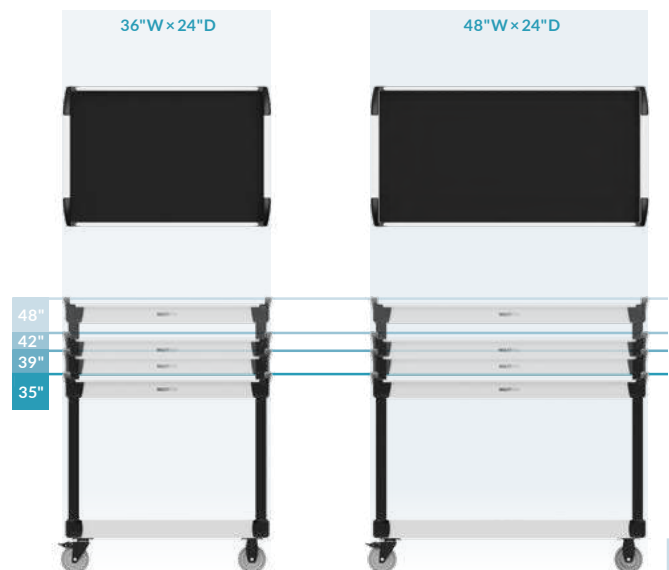

SHELF AND INTERMEDIATE SHELF DIMENSIONS

25"W x 16"D CART

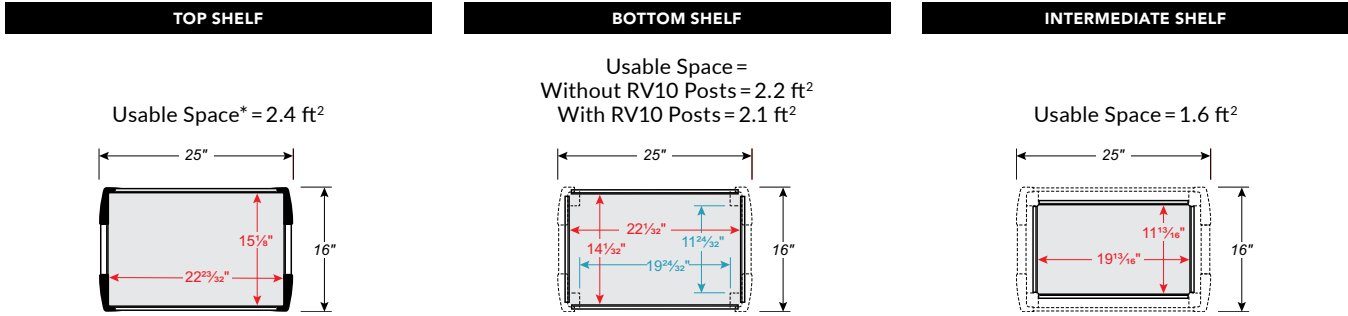

31"W x 21"D CART

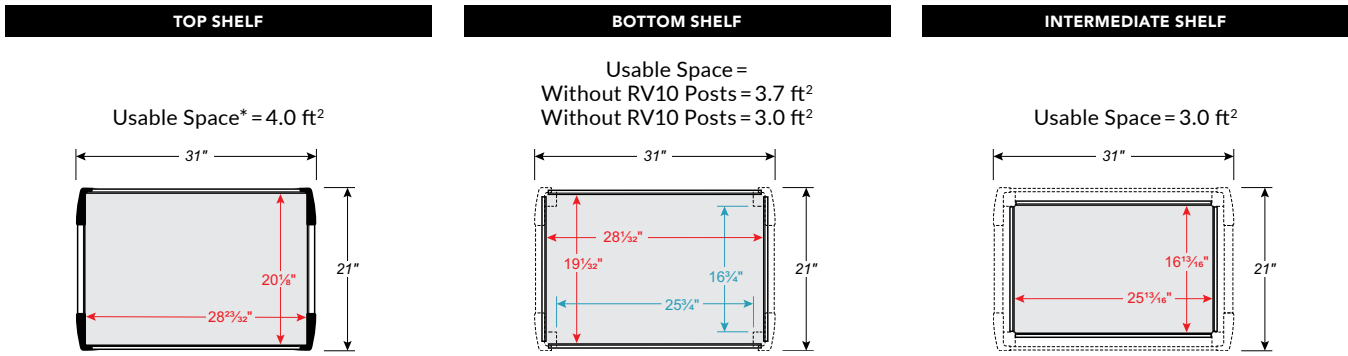

36"W x 24"D CART

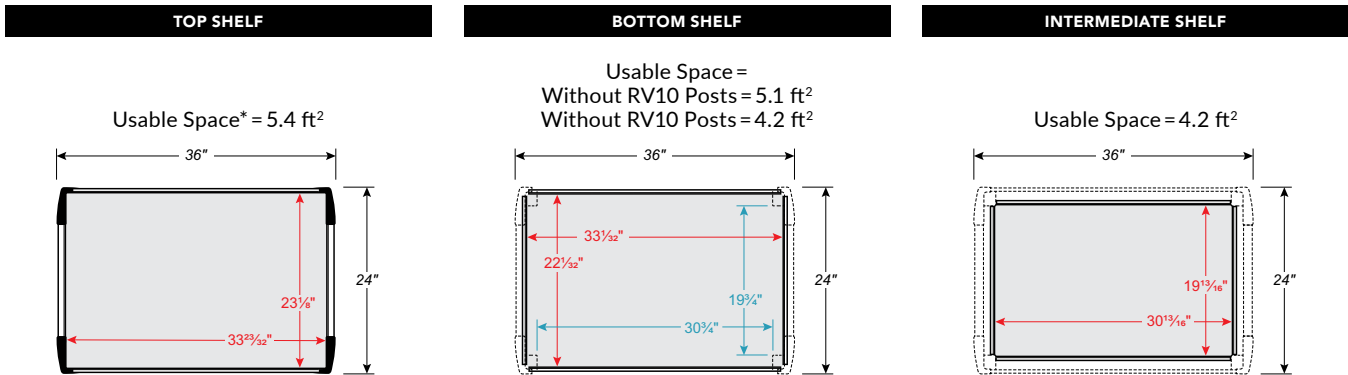

48"W x 24"D CART

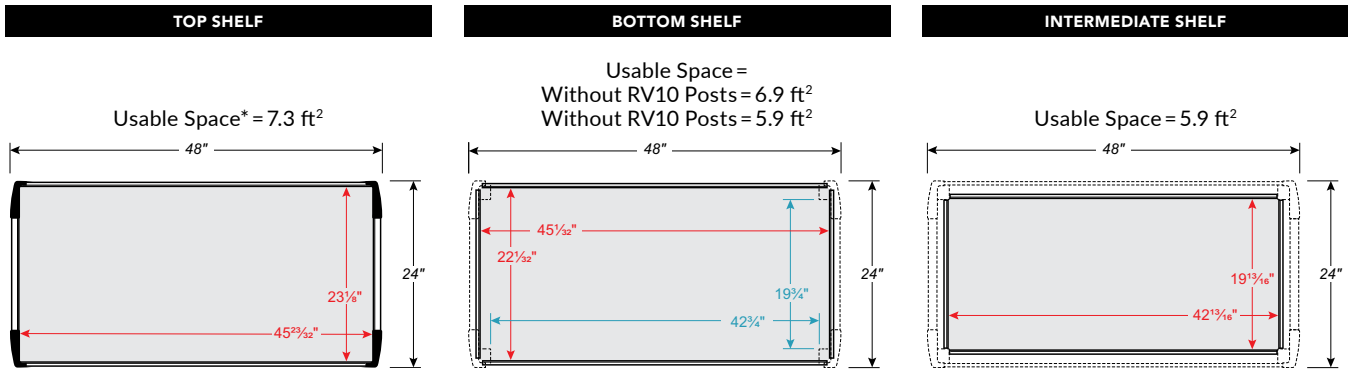

NOTE: \* The clearance corresponds to the space between the plastic end caps, which reduces the usable space.

## DRAWER AND ROLL-OUT SHELF DIMENSIONS

### 25"W x 16"D CART

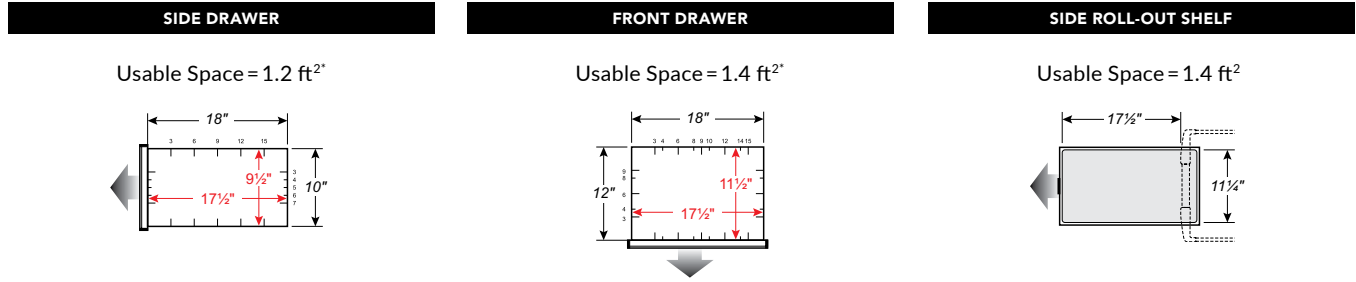

### 31"W x 21"D CART

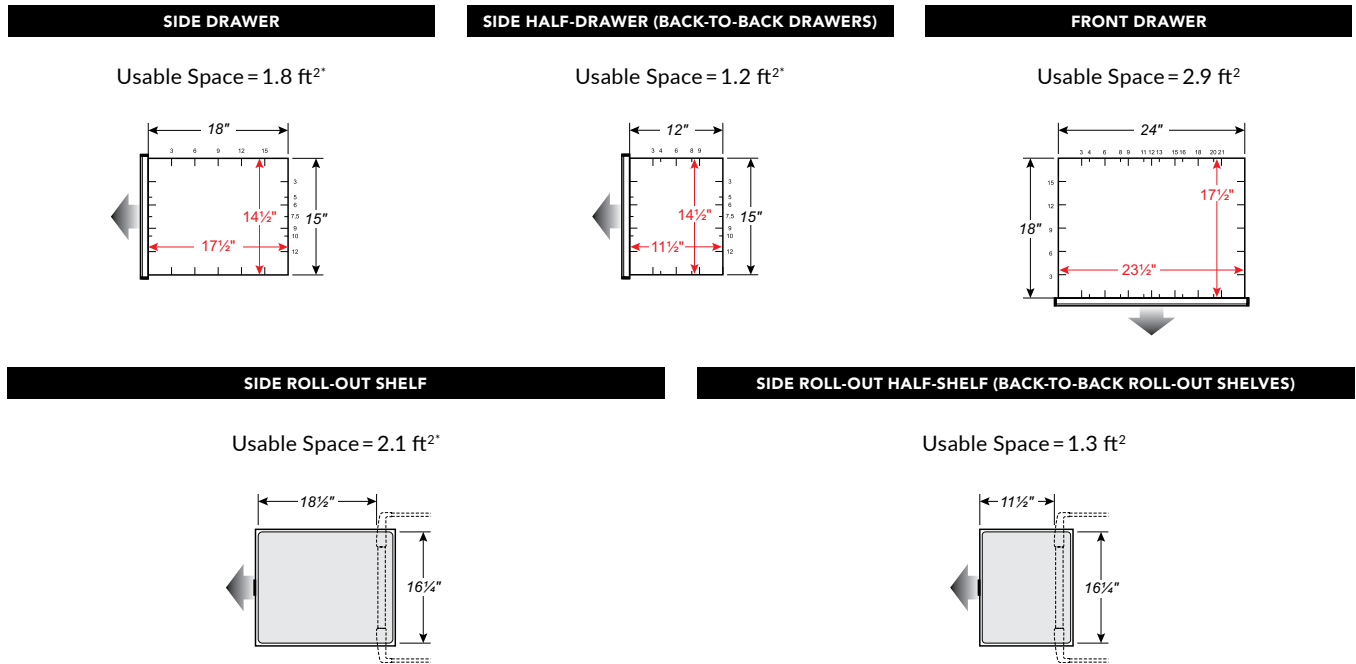

# PRECONFIGURED MODELS

## DRAWER COMPARTMENTS

SIDE DRAWERS FOR 25"W x 16"D CART

PARTITIONS AND DIVIDERS				GROOVE TRAYS *	
ROGBS-A010004 2 COMPARTMENTS	ROGBS-A010204 4 COMPARTMENTS	ROGBS-A010404 6 COMPARTMENTS	ROGBS-A011004 12 COMPARTMENTS	ROGBS-T01004 10 GROOVE TRAYS	ROGBS-T01204 12 GROOVE TRAYS
PLASTIC BINS			FOAM		
ROGBS-E01204 12 BINS	ROGBS-E01404 14 BINS	ROGBS-E01504 15 BINS	ROGBS-J0104 PROTECTIVE FOAM	ROGBS-J0204 TOOL FOAM	ROGBS-J0304 COLLET FOAM



FRONT DRAWERS FOR 25"W x 16"D CART

PARTITIONS AND DIVIDERS				GROOVE TRAYS *	
ROGBF-A020004 3 COMPARTMENTS	ROGBF-A010204 4 COMPARTMENTS	ROGBF-A020304 6 COMPARTMENTS	ROGBF-A051204 18 COMPARTMENTS	ROGBF-T00804 8 GROOVE TRAYS	ROGBF-T01004 10 GROOVE TRAYS
PLASTIC BINS			FOAM		
ROGBF-E00604 6 BINS	ROGBF-E01204 12 BINS	ROGBF-E01304 13 BINS	ROGBF-J0104 PROTECTIVE FOAM	ROGBF-J0204 TOOL FOAM	ROGBF-J0304 COLLET FOAM



NOTES: \* Two dividers included with each groove tray.  
 Preconfigured drawer layouts can be added to the MultiTek Cart preconfigured, [see pages 199-200](#).  
 Preconfigured drawer layouts include subdividing accessories only (not the drawer).

## SIDE HALF-DRAWERS FOR 31"W x 21"D CART

PARTITIONS AND DIVIDERS				GROOVE TRAYS*	
RONHB-A010004 2 COMPARTMENTS	RONHB-A010204 4 COMPARTMENTS	RONHB-A020304 6 COMPARTMENTS	RONHB-A020604 9 COMPARTMENTS	RONHB-T00604 6 GROOVE TRAYS	RONHB-T00804 8 GROOVE TRAYS
PLASTIC BINS			FOAM		
RONHB-E01204 12 BINS	RONHB-E01304 13 BINS	RONHB-E02004 20 BINS	RONHB-J0104 PROTECTIVE FOAM	RONHB-J0204 TOOL FOAM	RONHB-J0304 COLLET FOAM

**Sold without cut-outs**

## SIDE DRAWERS FOR 31"W x 21"D CART

PARTITIONS AND DIVIDERS				GROOVE TRAYS*	
RONHS-A010004 2 COMPARTMENTS	RONHS-A010204 4 COMPARTMENTS	RONHS-A010404 6 COMPARTMENTS	RONHS-A042504 30 COMPARTMENTS	RONHS-T00804 8 GROOVE TRAYS	RONHS-T01004 10 GROOVE TRAYS
PLASTIC BINS			FOAM		
RONHS-E01204 12 BINS	RONHS-E01804 18 BINS	RONHS-E02104 21 BINS	RONHS-J0104 PROTECTIVE FOAM	RONHS-J0204 TOOL FOAM	RONHS-J0304 TOOL FOAM

**Sold without cut-outs**

NOTES: \* Two dividers included with each groove tray.  
 Preconfigured drawer layouts can be added to the MultiTek Cart preconfigured, [see pages 201-202](#).  
 Preconfigured drawer layouts include subdividing accessories only (not the drawer).

# PRECONFIGURED MODELS

## FRONT DRAWERS FOR 31"W x 21"D CART

### PARTITIONS AND DIVIDERS

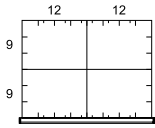

RONHF-A010204  
4 COMPARTMENTS

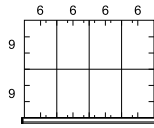

RONHF-A030404  
8 COMPARTMENTS

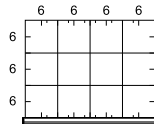

RONHF-A030804  
12 COMPARTMENTS

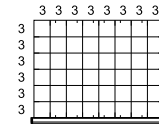

RONHF-A074004  
48 COMPARTMENTS

### GROOVE TRAYS\*

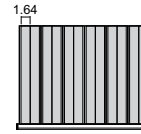

RONHF-T01204  
12 GROOVE TRAYS

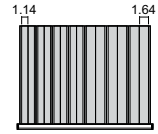

RONHF-T01404  
14 GROOVE TRAYS

### PLASTIC BINS

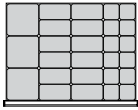

RONHF-E02704  
27 BINS

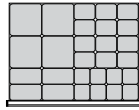

RONHF-E02804  
28 BINS

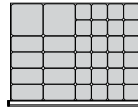

RONHF-E03404  
34 BINS

### FOAM



RONHF-J0104  
PROTECTIVE FOAM

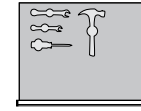

RONHF-J0204  
TOOL FOAM

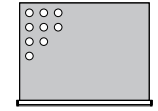

RONHF-J0304  
COLLET FOAM



NOTES: \* Two dividers included with each groove tray.  
 Preconfigured drawer layouts can be added to the MultiTek Cart preconfigured, [see pages 201-202](#).  
 Preconfigured drawer layouts include subdividing accessories only (not the drawer).





## 25"W x 16"D CARTS

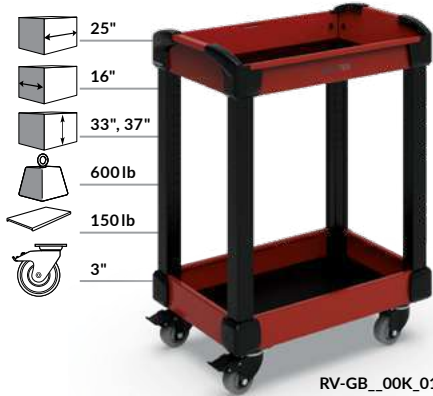

The 25"W x 16"D MultiTek Cart is compact and easy to maneuver. It offers plenty of storage space and multiple configurations

- Total load capacity: 600lb.
- Add intermediate shelves to transport more items
- The top, intermediate and bottom shelves each have a 150lb. load capacity
- The 4"H front and side drawers have a 50lb. load capacity and include a lock-in mechanism to prevent the drawers from opening by themselves
- The side roll-out shelf is lined with a rubber mat, has a 15lb. total load capacity and provides an extra work surface
- The cover features strategically placed gas springs to allow access to the top shelf when open. It is also equipped with a lock to secure the contents when closed
- For available accessories, [see pages 205-206](#)

### SPECIFY THE HEIGHT, MAT AND LOCK REQUIRED

Height:  
33" = 33    37" = 37

Rubber Mat on each shelf:  
With = 0    Whitout = 1

Drawer Lock = L3

RV-GB \_\_ A1F\_02 \_\_ B

### IMPORTANT

All models with shelves only are sold non-assembled.

### FRONT DRAWER



PRODUCT NO.  
RV-GB \_\_ A1F\_04 \_\_ B

### 2 FRONT DRAWERS



PRODUCT NO.  
RV-GB \_\_ A2F\_04 \_\_ B

### FRONT DRAWER, SIDE ROLL-OUT SHELF



PRODUCT NO.  
RV-GB \_\_ A1F\_02 \_\_ B

### 2 FRONT DRAWERS, SIDE ROLL-OUT SHELF



PRODUCT NO.  
RV-GB \_\_ A2F\_02 \_\_ B

### FRONT DRAWER, COVER, UTILITY PANEL



PRODUCT NO.  
RV-GB \_\_ A1UC10 \_\_ B<sup>1</sup>

### 2 FRONT DRAWERS, COVER, UTILITY PANEL, UPRIGHT BUMPERS



PRODUCT NO.  
RV-GB \_\_ A2UC12 \_\_ B<sup>1</sup>

NOTE: <sup>1</sup>For this model without a rubber mat replace the letter C with L.

# PRECONFIGURED MODELS

SIDE DRAWER



PRODUCT NO.  
RV-GB\_S1F\_04\_B

2 SIDE DRAWERS



PRODUCT NO.  
RV-GB\_S2F\_04\_B

2 SIDE DRAWERS,  
SIDE ROLL-OUT SHELF



PRODUCT NO.  
RV-GB\_S2F\_06\_B

2 SIDE DRAWERS,  
SIDE ROLL-OUT SHELF, COVER,  
UTILITY PANELS, UPRIGHT BUMPERS



PRODUCT NO.  
RV-GB\_S2X\_02\_B

SIDE DRAWER, SIDE ROLL-OUT SHELF



PRODUCT NO.  
RV-GB\_S1F\_06\_B

SIDE ROLL-OUT SHELF



PRODUCT NO.  
RV-GB\_00F\_01



## 31"W x 21"D CARTS



RV-NH\_\_00K\_01

The 31"W x 21"D cart offers plenty of storage space and multiple configurations. With this size, you can have roll-out shelves or drawers on both sides of the cart

- Total load capacity: 600lb.
- Add intermediate shelves to transport more items
- The top, intermediate and bottom shelves each have a 150lb. load capacity
- The 4"H front and side drawers have a 50lb. load capacity and include a lock-in mechanism to prevent the drawers from opening by themselves
- The side roll-out shelf is lined with a rubber mat, has a 15lb. total load capacity and provides an extra work surface
- The cover features strategically placed gas springs to allow access to the top shelf when open. It is also equipped with a lock to secure the contents when closed
- For available accessories, [see pages 205-206](#)

### SPECIFY THE HEIGHT, MAT AND LOCK REQUIRED

Height:  
33" = 33    37" = 37  
40" = 40

Rubber Mat on each shelf:  
With = 0    Whitout = 1

Drawer Lock = L3

RV-NH\_\_A1F\_02\_\_B

### IMPORTANT

All models with shelves only are sold non-assembled.

### SIDE DRAWER



PRODUCT NO.

RV-NH\_\_S1F\_04\_\_B

### 2 SIDE DRAWERS



PRODUCT NO.

RV-NH\_\_S2F\_04\_\_B

### 3 SIDE DRAWERS



PRODUCT NO.

RV-NH\_\_S3F\_04\_\_B

### 3 FRONT DRAWERS, COVER, PLASTIC BIN PANEL, UPRIGHT BUMPERS



PRODUCT NO.

RV-NH\_\_A3X\_02\_\_B

### 3 FRONT DRAWERS, COVER, UTILITY PANEL, UPRIGHT BUMPERS



PRODUCT NO.

RV-NH\_\_A3UC16\_\_B<sup>1</sup>

### SIDE ROLL-OUT SHELF



PRODUCT NO.

RV-NH\_\_00F\_01

NOTE: <sup>1</sup>For this model without a rubber mat replace the letter C with L.

# PRECONFIGURED MODELS

**FRONT DRAWER,  
2 SIDE ROLL-OUT HALF-SHELVES**



PRODUCT NO.  
RV-NH\_A1F\_06\_B

**2 FRONT DRAWERS,  
2 SIDE ROLL-OUT HALF-SHELVES**



PRODUCT NO.  
RV-NH\_A2F\_06\_B

**2 FRONT DRAWERS,  
2 SIDE ROLL-OUT HALF-SHELVES,  
COVER, UTILITY PANEL**



PRODUCT NO.  
RV-NH\_A2UC06\_B<sup>1</sup>

**2 SIDE HALF-DRAWERS**



PRODUCT NO.  
RV-NH\_B2F\_02\_B

**FRONT DRAWER,  
2 SIDE HALF-DRAWERS**



PRODUCT NO.  
RV-NH\_M3F\_02\_B

**2 SIDE ROLL-OUT HALF-SHELVES**



PRODUCT NO.  
RV-NH\_00F\_02

**3 SHELVES**



PRODUCT NO.  
RV-NH\_00K\_07

**3 SHELVES, UTILITY PANELS**



PRODUCT NO.  
RV-NH\_00U\_07

**3 SHELVES WITH TOOL FOAM<sup>2</sup>,  
UTILITY PANEL, LONG TOOL HOLDER**



PRODUCT NO.  
RV-NH\_00U210<sup>2</sup>

NOTE: <sup>1</sup>For this model without a rubber mat replace the letter C with L. <sup>2</sup>Sold without cut-outs.

## 36"W x 24"D CARTS

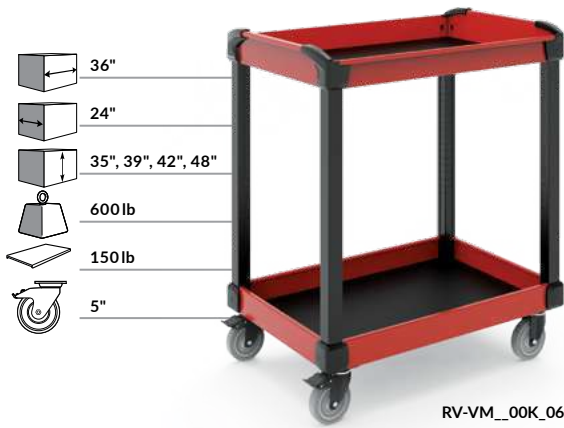

The 36"W x 24"D MultiTek Cart is ideal for transporting large parts. You will find it quickly becomes indispensable in your department.

- Total load capacity: 600lb.
- Add intermediate shelves to transport more items
- The top, intermediate and bottom shelves each have a 150lb. load capacity
- For available accessories, [see pages 205-206](#)

**SPECIFY THE HEIGHT AND MAT**

Height:	35" = <u>35</u>	39" = <u>39</u>	Rubber Mat on each shelf: With = <u>0</u> Whitout = <u>1</u>
	42" = <u>42</u>	48" = <u>48</u>	

RV-VM\_00K\_06

**IMPORTANT**

All models with shelves only are sold non-assembled.

### 2 SHELVES



PRODUCT NO.  
RV-VM\_00K\_06

### 3 SHELVES



PRODUCT NO.  
RV-VM\_00K\_08

### 4 SHELVES



PRODUCT NO.  
RV-VM\_00K\_09

### 2 SHELVES, UTILITY PANELS



PRODUCT NO.  
RV-VM\_00U\_06

### 3 SHELVES, UTILITY PANELS



PRODUCT NO.  
RV-VM\_00U\_08

### 4 SHELVES, UTILITY PANELS



PRODUCT NO.  
RV-VM\_00U\_09

# PRECONFIGURED MODELS

## 48"W x 24"D CARTS

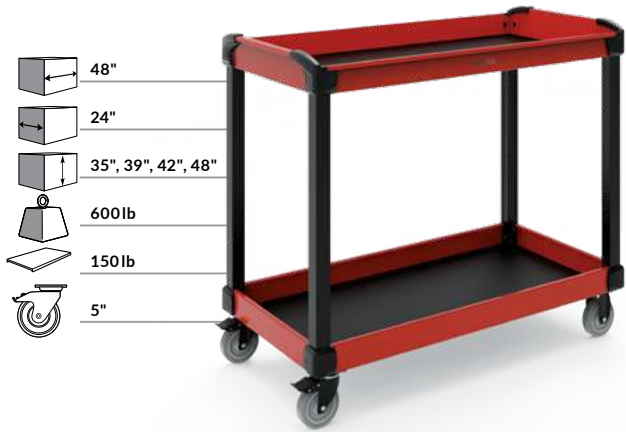

RV-ZM\_\_00K\_06

The 48"W x 24"D MultiTek Cart is ideal for transporting large parts. You will find it quickly becomes indispensable in your department.

- Total load capacity: 600lb.
- Add intermediate shelves to transport more items
- The top, intermediate and bottom shelves each have a 150lb. load capacity
- For available accessories, [see pages 205-206](#)

**SPECIFY THE HEIGHT AND MAT**

Height: 35" = <u>35</u>	39" = <u>39</u>	Rubber Mat on each shelf: With = <u>0</u> Whitout = <u>1</u>
42" = <u>42</u>	48" = <u>48</u>	

RV-ZM\_\_00K\_06

**IMPORTANT**

All models with shelves only are sold non-assembled.

### 2 SHELVES



PRODUCT NO.  
RV-ZM\_\_00K\_06

### 3 SHELVES



PRODUCT NO.  
RV-ZM\_\_00K\_08

### 4 SHELVES



PRODUCT NO.  
RV-ZM\_\_00K\_09

### 2 SHELVES, UTILITY PANELS



PRODUCT NO.  
RV-ZM\_\_00U\_06

### 3 SHELVES, UTILITY PANELS



PRODUCT NO.  
RV-ZM\_\_00U\_08

### 4 SHELVES, UTILITY PANELS



PRODUCT NO.  
RV-ZM\_\_00U\_09

## ACCESSORIES

### INTERMEDIATE SHELF

RV25



- Load capacity: 150lb. per shelf, 600lb. max. per cart
- One or two shelves can be added to the cart
- Compatible with finishing panels, utility panels and plastic bin panels
- Thickness: 2"

PRODUCT NO.	W × D
RV25-2516	25" × 16"
RV25-3121	31" × 21"
RV25-3624	36" × 24"
RV25-4824	48" × 24"

### NON-SLIP PVC LINER FOR SHELF

RV44 / RV74



- Protects items stored on a shelf
- One piece of 1/16"-thick
- To order a PVC Liner for a top or bottom shelf: [RV44](#)
- To order a PVC Liner for an intermediate shelf: [RV74](#)

PRODUCT NO.	W × D
RV_-2516-01	25" × 16"
RV_-3121-01	31" × 21"
RV_-3624-01	36" × 24"
RV_-4824-01	48" × 24"

### TOOL FOAM FOR SHELF

RV47 / RV77



- Oil resistant and non-absorbent
- One piece of 1/4"-thick blue foam
- One piece of 1/2"-thick self-adhesive black foam
- To order tool foam for a top or bottom shelf: [RV47](#)
- To order tool foam for an intermediate shelf: [RV77](#)

PRODUCT NO.	W × D
RV_-2516-01	25" × 16"
RV_-3121-01	31" × 21"
RV_-3624-01	36" × 24"
RV_-4824-01	48" × 24"



Sold without cut-outs.

NOTE: Sold without cut-outs.

### PROTECTIVE FOAM FOR SHELF

RV46 / RV76



- Protects items stored on a shelf
- One piece of 1/4"-thick blue foam
- To order protective foam for a top or bottom shelf: [RV46](#)
- To order protective foam for an intermediate shelf: [RV76](#)

PRODUCT NO.	W × D
RV_-2516-01	25" × 16"
RV_-3121-01	31" × 21"
RV_-3624-01	36" × 24"
RV_-4824-01	48" × 24"

### UPRIGHT BUMPERS

RV63



- Kit of four protective bumpers
- Protects surrounding objects and the cart itself
- Made from soft PVC

PRODUCT NO.	MULTITEK CART (W × D)		
	25" × 16"	31" × 21"	36" × 24"
RV63-29	33"H	33"H	35"H
RV63-33	37"H	37"H	39"H
RV63-36		40"H	42"H
RV63-42			48"H

### LONG TOOL HOLDER

WM9Q



- For storing long tools, e.g., pry bars
- Easy to install
- Holds up to three long tools;
- Space available for two smaller tools, e.g., screwdrivers

PRODUCT NO.	W × D × H
WM9Q-08	8" × 2" × 4"

NOTE: A range of holders, hooks and accessories are also available, see pages 214-215.

## PVC DRAWER LINER

RV40



- Protects items stored in drawers
- 1/16" thick
- Can be used under partitions and dividers

PRODUCT NO.	DRAWER	CART WIDTH
RV40-1623-01S	Side	25"
RV40-2131-01S	Side	31"
RV40-2131-01S2	Side Half	31"
RV40-2516-01F	Front	25"
RV40-3121-01F	Front	31"

## PROTECTIVE FOAM FOR DRAWER

RV41



- Protects items stored in the drawer
- One piece of 1/4"-thick blue foam

PRODUCT NO.	DRAWER	CART WIDTH
RV41-1623-01S	Side	25"
RV41-2131-01S	Side	31"
RV41-2131-01S2	1/2 Side	31"
RV41-2516-01F	Front	25"
RV41-3121-01F	Front	31"

NOTE: Partitions and dividers cannot be installed in the same drawer as this foam.

## TOOL FOAM FOR DRAWER

RV42



- Oil resistant and non-absorbent
- One piece of 1/4"-thick blue foam
- One piece of 1/2"-thick self-adhesive black foam

PRODUCT NO.	DRAWER	CART WIDTH
RV42-1623-01S	Side	25"
RV42-2131-01S	Side	31"
RV42-2131-01S2	1/2 Side	31"
RV42-2516-01F	Front	25"
RV42-3121-01F	Front	31"



Sold without cut-outs.

## DRAWER LOCK

L3



- Drawer can be locked with the same key used for other products (cover for the cart's shelf, tool box, storage cabinet, etc.)
- Does not reduce the drawer's storage space
- Easy to retrofit
- To order: Add L3 to the product number

PRODUCT NO.
L3

## CASTERS

RV82 / RV83



- Available in two heights: 3" and 5"
- Sold in pairs
- Three types of casters available: fixed, swivel and swivel with brake
- Ultra-quiet casters
- Good chemical resistance

PRODUCT NO.	CASTER TYPE	HEIGHT	ACTUAL
RV82-01	Rigid	3"	4 1/4"
RV82-02	Swivel	3"	4 1/4"
RV82-03	Swivel with brake	3"	4 1/4"
RV83-01	Rigid	5"	6"
RV83-02	Swivel	5"	6"
RV83-03	Swivel with brake	5"	6"

NOTES: 25"W x 16"D and 31"W x 21"D MultiTek models include 3" wheels by default. 36"W x 24"D and 48"W x 24"D MultiTek models include 5" wheels by default.





# FREESTANDING STATION



## FREESTANDING STATION

With a Rousseau Freestanding Station, you can keep a wide variety of accessories within easy reach, from the simplest tools to computer parts, spools holders and electronic equipment.

Both the centered and off-centered stands give you fast access to every item stored on them. Stationary stands are available in 36"H, 54"H and 84"H models, and there are also 36"H and 54"H mobile versions for easily transporting your equipment to wherever you need it.

The layout of accessories on Rousseau Freestanding Stations can be easily changed without tools. Simply swap them in and out or rearrange them to ensure the stand evolves in line with your needs.



WMA4050

## THE ROUSSEAU DIFFERENCE



Wide range of accessories for building a highly personalized layout.



All components are installed on the uprights with plastic screw knobs or hooks.



Easy and tool-free reconfiguration means that your system can evolve in line with your needs.



36"H and 54"H stands can be made mobile for added flexibility.

## HOW TO ORDER

**WHEN ORDERING, MODEL NUMBERS MUST BE COMPLETED AS FOLLOWS**

**0:** For 32" wide (uprights 28" c/c)  
**3:** For 38" wide (uprights 34" c/c)

WMA5 0

**STATIONARY MODELS:**  
**0:** With floor anchoring kit  
**1:** With leveling glides kit

**MOBILE MODELS (54"H STANDS ONLY):**  
**2:** With handle and 4" casters: 2 rigid and 2 swivel with total-lock brake  
**3:** With handle and 4" casters: 2 swivel and 2 swivel with total-lock brake  
**4:** With handle and 6" casters: 2 rigid and 2 swivel with total-lock brake  
**5:** With handle and 6" casters: 2 swivel and 2 swivel with total-lock brake

NOTE: Any accessories not mentioned in the description are not sold by Rousseau.

## WM STAND STABILITY AND LOAD CAPACITY

**LEGEND**

- Workstation is stable and safe
- Configuration not recommended

**36"H AND 54"H STANDS**

600  
Per side

Maximum load capacity: 1,200lb. evenly distributed

**84"H STANDS**

700  
Maximum

Maximum load capacity: 700lb. on one side or distributed over both sides

## 54"H FREESTANDING STATIONS

### STOREKEEPER MODEL



WMA1012

- 1 centered WM stand, 54"H
- 8 plastic bin rails
- 1 document holder
- 1 bottom shelf with ribbed mat

PRODUCT NO.	W x D x H
WMA101_	32" x 27" x 59 1/4"
WMA131_	38" x 27" x 59 1/4"



WMA1052

- 1 centered WM stand, 54"H
- 2 tiltable shelves
- 6 partial dividers
- 1 bottom shelf with ribbed mat
- 2 tiltable pans

PRODUCT NO.	W x D x H
WMA105_	32" x 27" x 59 1/4"
WMA135_	38" x 27" x 59 1/4"

### WIRE SPOOL MODEL



WMA1032

- 1 centered WM stand, 54"H
- 1 bottom shelf with ribbed mat
- 8 wire spool holders

PRODUCT NO.	W x D x H
WMA103_	32" x 27" x 59 1/4"
WMA133_	38" x 27" x 59 1/4"

### 5S MODEL



WMA1382

- 1 centered WM stand, 54"H
- 2 tiltable shelves
- 2 utility panels
- 1 bottom shelf with ribbed mat
- 4 plastic bin rails
- 2 tool holders
- 4 heavy-duty round hooks
- 2 heavy-duty square hooks
- 2 wire spool holders
- 2 can holders

PRODUCT NO.	W x D x H
WMA108_	32" x 27" x 59 1/4"
WMA138_	38" x 27" x 59 1/4"

# PRECONFIGURED MODELS

## 84"H FREESTANDING STATIONS

### TO ORDER

Product numbers must be completed with the option required from the following.

#### Stationary models:

0 = With floor anchoring kit

1 = With leveling glides kit

NOTE: Any accessories not mentioned in the description are not sold by Rousseau.

## LABELING MODEL



WMA3021

- 1 centered WM stand, 84"H
- 2 tiltable shelves
- 6 partial dividers
- 4 plastic bin rails
- 6 wire spool holders
- 2 document holders
- 1 bottom shelf with ribbed mat

PRODUCT NO.	W x D x H
WMA302_	32" x 27" x 85"
WMA332_	38" x 27" x 85"

## REPAIR AND MAINTENANCE MODEL



WMA3031

- 1 centered WM stand, 84"H
- 2 cantilever overhead supports
- 2 overhead workstation lights
- 2 tiltable shelves
- 6 partial dividers
- 2 utility panels
- 1 panel bracket kit
- 2 packs of 10 double back single hooks
- 2 wire spool holders
- 2 vertical adapters for power outlet strip and pneumatic connection
- 2 power outlet strips
- 2 document holders with arm

PRODUCT NO.	W x D x H
WMA303_	32" x 27" x 85"
WMA333_	38" x 27" x 85"

## ELECTRONICS MODEL



WMA4041

- 1 off-centered WM stand, 84"H
- 1 cantilever overhead support
- 1 overhead workstation light
- 1 plastic bin rail
- 1 storage cabinet with door and lock
- 6 partial dividers
- 1 tiltable pan
- 1 vertical adapter for power outlet strip and pneumatic connection
- 1 power outlet strip
- 1 lamp with magnifier and LED light
- 1 adapter for light-duty arm

PRODUCT NO.	W x D x H
WMA404_	32" x 27" x 85"
WMA434_	38" x 27" x 85"

## COMPUTER MODEL



WMA4021

- 1 off-centered WM stand, 84"H
- 2 tiltable shelves
- 6 partial dividers
- 1 bottom shelf with ribbed mat
- 1 tiltable pan
- 1 document holder with arm
- 1 vertical adapter for power outlet strip and pneumatic connection
- 1 power outlet strip

PRODUCT NO.	W x D x H
WMA402_	32" x 27" x 85"
WMA432_	38" x 27" x 85"

**WM STAND**

**WMA**



- Two widths available: 32" (28" c/c between uprights) and 38" (34" c/c between uprights)
- Three heights available: 36", 54" and 84"
- Centered and off-centered stands available
- The uprights have six fixing zones to minimize interference between components
- To order: Specify the width and model required according to the chart, see page 209

PRODUCT NO.	HEIGHT	TYPE
WMA5_0_	36"	Centered
WMA6_0_	36"	Off-centered
WMA1_0_	54"	Centered
WMA2_0_	54"	Off-centered
WMA3_0_	84"	Centered
WMA4_0_	84"	Off-centered

**REPLACEMENT HANDLE**

**WS74**



- Aluminum with plastic end caps
- Installs on the side of a WM stand
- Included with 54"H mobile WM stands
- Modern, attractive design

**PRODUCT NO.**  
WS74-1202

**SHELF FOR WM UPRIGHT**

**WM84**



- Usable shelf area : 14"W x 8"D x 1"H
- Horizontal aluminum handle with plastic end caps, available for 36"H mobile WM stands only

PRODUCT NO.	DESCRIPTION
WM84-081401	With handle, for 36"H mobile stands
WM84-081402	Without handle, for 36"H, 54"H and 84"H stands

**PROTECTIVE BUMPERS**

**WM92**



- L-shaped bumper that screws into riveted nuts on a base with three machine screws
- Sold in kits of four

**PRODUCT NO.**  
WM92-01

**CASTERS**

**LB81 / LB84**



- Three types of casters available: rigid, swivel and swivel with total-lock brake (on wheel and swivel)
- 4" casters: 440lb. load capacity; total height: 5 1/4"
- 6" casters: 1100lb. load capacity; total height: 7 1/2"
- Heavy-duty, non-marking polyurethane casters; Superior industrial quality
- Included with 36"H and 54"H mobile WM stands

**BOTTOM SHELF**

**WM83**



- Installs on the bottom of a WM stand
- Includes a resistant ribbed mat
- Dimensions: 26"W x 22 3/4"D and 32"W x 22 3/4"D (int. dim.)

PRODUCT NO.	STRUCTURE
WM83-282701	Centered
WM83-282702	Off-centered
WM83-342701	Centered
WM83-342702	Off-centered

**DOCUMENT HOLDER**

**WM90**



- Specially designed for WM stands
- Keeps paperwork and manuals accessible and organized

**PRODUCT NO.**  
WM90-01

NOTE: All 28"W and 34"W multi-purpose upright accessories are compatible with WM stands AS LONG AS all security recommendations are followed, see pages 164-171. For further information, please contact your customer service representative.

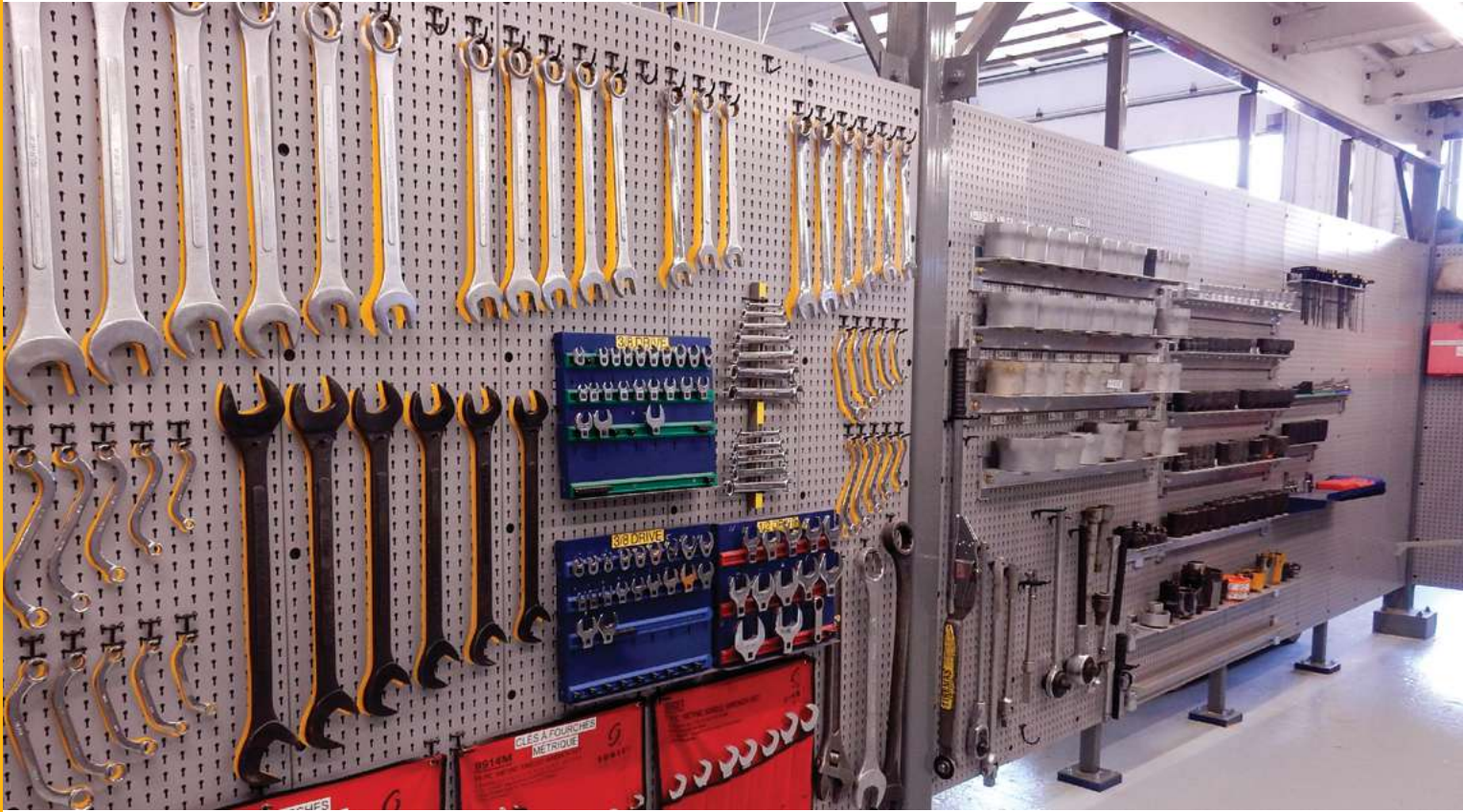

## 5S AND WALL-MOUNTED STORAGE

Many Rousseau products are available in a wall-mounted version to help you organize and maximize your available space while keeping floors clear. Wall-mounting makes cleaning easier and everything you need is still within easy reach.

Over the years, Rousseau has also developed many different storage solutions to meet the standards of the 5S methodology. The aim of this Japanese technique is to continuously improve the work environment. Its name comes from the same first letter used to illustrate its five fundamental principles: Sort, Set in Order, Shine, Standardize and Sustain. It is designed to optimize organization and efficiency of the work environment by ensuring each tool is in the right place, easy to find and well identified.

A choice of 20 standard colors is also available to color code your 5S management.



## ORGANIZATIONAL WALL STRUCTURES

### WALL-MOUNTED MULTI-PURPOSE FRAME

### WM35



- Load capacity: 300lb. (if wall and wall anchoring are of sufficient strength)
- A combination of three wall-mounted uprights can support 500lb.
- Perforated on the front faces in 1" increments c/c for optimal placement of accessories (see compatible accessories)
- Wall anchoring hardware not included
- Compatible accessories (space between uprights must be 28" or 34" c/c):
  - WM18 Cantilever Overhead Supports
  - WM20 Tilttable Shelf
  - WM22 Tilttable Pan
  - WM27 Structural Shelf Supports
  - WM28 Plastic Bin Rail
  - WM31 Wire Spool Holder
  - WM40 Power Outlet Channel
  - WM55 Panel for Plastic Bin Panel
  - WM59 Utility Panel
  - WM75 Storage Cabinet
  - RD00 R Cabinet Housing
  - NC50 WM Adapter (with NC10 and NC12 tool racks)

PRODUCT NO.	HEIGHT	NO. OF UPRIGHTS
WM35-7201	72"	1
WM35-7202	72"	2
WM35-7203	72"	3

### WALL-MOUNTED UTILITY PANEL

### WM57 / WM5B



- Painted steel utility panel: WM57
- Stainless steel utility panel: WM5B
- For storing small- and medium-sized tools with visual identification close to the user or in a store
- Completely flat surface for easy visual identification with photos, P-touch, stickers or WM91 vinyl decals
- The panels overlap to anchor in the same anchoring zones
- Two widths available: 16" (16 holes) and 24" (24 holes)
- The installation hardware is between two panels for easy assembly
- 16"W: Vertical installation and conforms with architectural standards with uprights spaced 16" c/c
- Compatible with WM9F, WM9G, WM9H, WM9J and WM9L light-duty hooks, and WM9A and WM9B heavy-duty hooks
- Compatible with WM9C rails, and WM9D, WM9M, WM9N, WM9P and WM9Q holders
- Compatible with WM21 shelves, [see page 98](#)
- To order: Specify the height required: 18", 24", 36", 48" or 72"

PRODUCT NO.	FINISH	WIDTH
WM57-16_ _	Painted Steel	16"
WM57-24_ _	Painted Steel	24"
WM5B-16_ _	Stainless Steel	16"
WM5B-24_ _	Stainless Steel	24"

### FINISHING PANEL

### WM58 / WM5D



- Painted steel panel: WM58
- Stainless steel panel: WM5D
- Finishing panel for the end of a wall panel layout
- Quick and easy installation
- Creates a neater appearance
- To order: Specify the type of steel required, e.g., WM58-36

PRODUCT NO.	HEIGHT
WM_ _-18	18"
WM_ _-24	24"
WM_ _-36	36"
WM_ _-48	48"
WM_ _-72	72"

NOTE: Compatible with a wall panel of the same height, e.g., WM58-36 is only compatible with WM57-1636.

### WALL-MOUNTED PLASTIC BIN PANEL

### WM5C



- Holds RG20 plastic bins
- Compatible with all commercially available brands of plastic bins with a hanging lip
- Quick and easy installation
- The panels overlap to anchor in the same anchoring zones
- Two widths available: 16" and 24"
- 16"W: Vertical installation and conforms with architectural standards with uprights spaced 16" c/c
- To order: Specify the height required: 18", 24", 36", 48" or 72"

PRODUCT NO.	WIDTH
WM5C-16_ _	16"
WM5C-24_ _	24"

# COMPONENTS

## HOOKS AND HOLDERS

### LIGHT-DUTY HOOKS

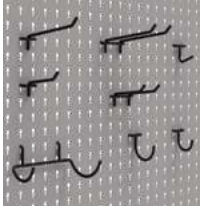

Our family of hooks makes it possible for you to store several types of parts, tools and accessories adequately. Compatible with the panels currently available on the market (1/4" holes), Rousseau utility panels (WM57, WM59, WM5A, WM5B, SH67, SH68, SH69, SH77, SH79, SR79, RC02, RC93 and RC94).

TYPE/PACK	DIMENSIONS	PRODUCT NO.
Straight hooks/20	1 1/2"D	WM9F-150
Single hooks/20	1 1/2" dia.	WM9G-150
Single hooks/20	2" dia.	WM9G-200
Double back single hooks/10	3"D	WM9H-03
Double back single hooks/10	5"D	WM9H-05
Double back double hooks/10	3"D	WM9J-03
Double back double hooks/10	5"D	WM9J-05
Drill holder/1	5"W x 3 1/2"D	WM9L-01

### HEAVY-DUTY SQUARE HOOK

WM9A



- Hooks onto utility panels (WM57, WM59, WM5A, WM5B, SH67, SH68, SH69, SH77, SH79, SR79, RC02, RC93 and RC94)
- Flat surface on top
- Raised end to prevent accessories or tools from sliding off
- Hook-on installation
- Includes side notches for extra stability
- 50lb. load capacity
- Sold individually
- 1"W (two holes)
- Color: black

PRODUCT NO.	LENGTH
WM9A-03	3"
WM9A-06	6"
WM9A-12	12"

### HEAVY-DUTY ROUND HOOK

WM9B

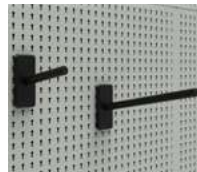

- Hooks onto utility panels (WM57, WM59, WM5A, WM5B, SH67, SH68, SH69, SH77, SH79, SR79, RC02, RC93 and RC94)
- 3/4" dia. tube
- Tools and accessories slide on and off easily
- Hook-on installation
- Includes side notches for extra stability
- 50lb. load capacity
- Sold individually
- Hook base: 2"W (three holes) x 5"H
- Color: black

PRODUCT NO.	LENGTH
WM9B-03	3"
WM9B-06	6"
WM9B-12	12"

### PLASTIC BIN RAIL

WM9C



- Hooks onto utility panels (WM57, WM59, WM5A, WM5B, SH67, SH68, SH69, SH77, SH79, SR79, RC02, RC93 and RC94)
- Plastic bins hook onto the rail for efficient storage of small parts
- Hook-on installation
- Includes side notches for extra stability
- Compatible with all brands of plastic bins with hanging lip on the market
- Compatible with RG20 plastic bins
- Bins sold separately
- Widths available: 6" (7 holes), 9" (10 holes), 12" (13 holes), 15" (16 holes), 20" (21 holes), 23" (24 holes) and 26" (27 holes)
- To order: specify the width required

PRODUCT NO.	HEIGHT
WM9C-__	3"

### CAN HOLDER

WM9D

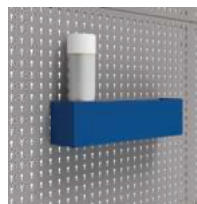

- Hooks onto utility panels (WM57, WM59, WM5A, WM5B, SH67, SH68, SH69, SH77, SH79, SR79, RC02, RC93 and RC94)
- Ideal for storing various items of different sizes, such as aerosol cans
- Hook-on installation
- Includes side notches for extra stability
- Widths available: 6" (7 holes), 9" (10 holes), 12" (13 holes), 14" (15 holes), 15" (16 holes) and 20" (21 holes)
- To order: specify the width required

PRODUCT NO.	D x H
WM9D-__	3" x 4"



### PLIERS HOLDER

WM9M



- Hooks onto utility panels (WM57, WM59, WM5A, WM5B, SH67, SH68, SH69, SH77, SH79, SR79, RC02, RC93 and RC94)
- Holds up to six pliers

PRODUCT NO.	W×D×H
WM9M-01	9"×2" ½×2"

### SCREWDRIVER HOLDER

WM9N

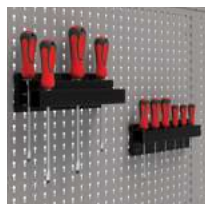

- Hooks onto utility panels (WM57, WM59, WM5A, WM5B, SH67, SH68, SH69, SH77, SH79, SR79, RC02, RC93 and RC94)
- Holds 6-12 screwdrivers

PRODUCT NO.	VERSION	W×D×H
WM9N-01	Single	9"×1" ½×2"
WM9N-02	Double	9"×3" ¼×2"

### LONG TOOL HOLDER

WM9Q



- Hooks onto utility panels (WM57, WM59, WM5A, WM5B, SH67, SH68, SH69, SH77, SH79, SR79, RC02, RC93 and RC94) for hanging long tools
- Holds up to three long tools
- Easy to install
- Color: black

PRODUCT NO.	W×D×H
WM9Q-08	8"×3"×4"

### WIRE SPOOL AND ROLL HOLDER

WM9P



- Hooks onto utility panels (WM57, WM59, WM5A, WM5B, SH67, SH68, SH69, SH77, SH79, SR79, RC02, RC93 and RC94)
- Ideal for wire spools or paper towel rolls
- Tube diameter: ¾"
- Load capacity: 50lb.

PRODUCT NO.	WIDTH	NO. OF HOLES
WM9P-0901	9"	10
WM9P-1201	12"	13
WM9P-1501	15"	16
WM9P-2001	20"	21
WM9P-2301	23"	24
WM9P-2601	26"	27

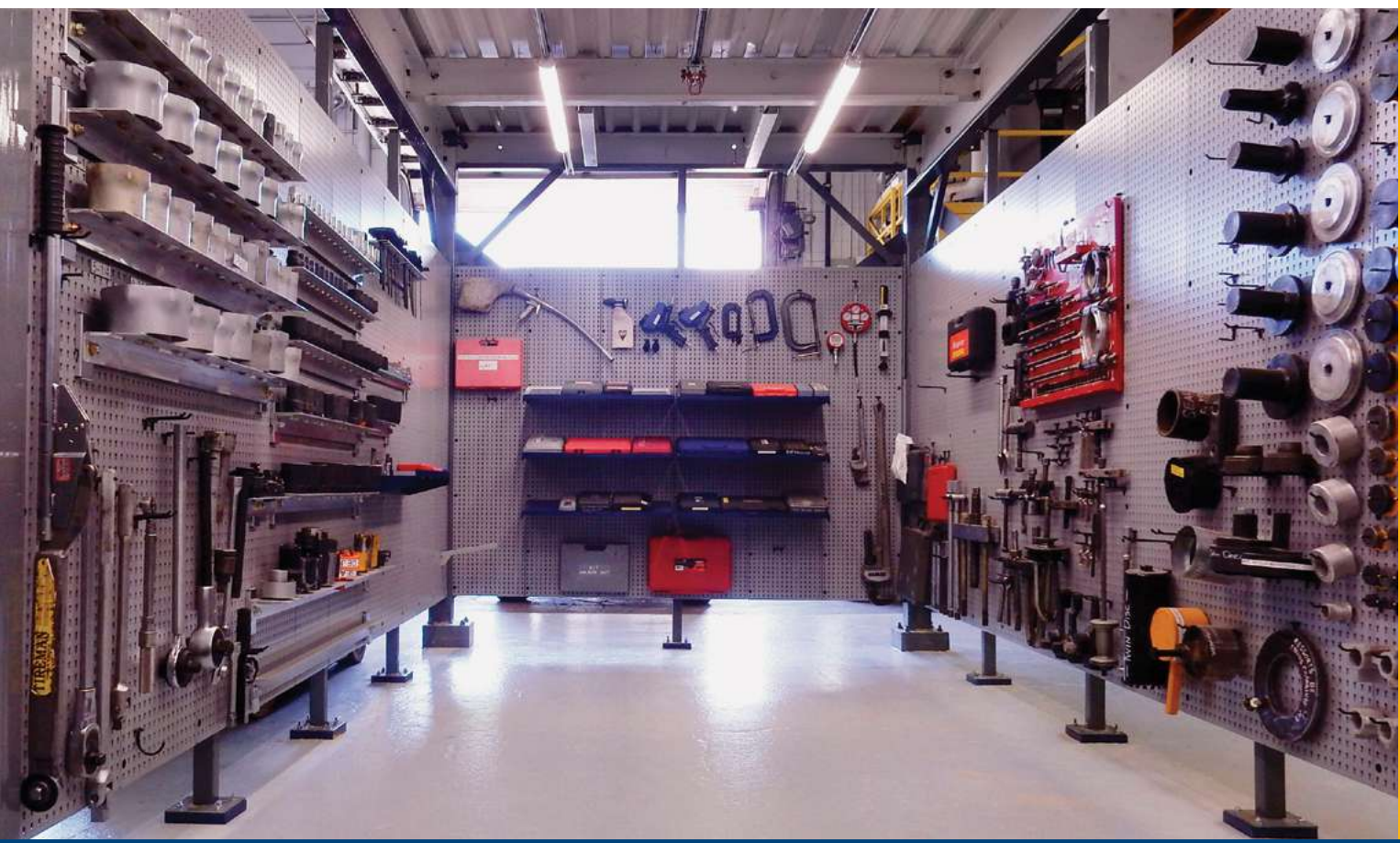

# COMPONENTS

## 5S IDENTIFICATION



With a wide selection of identification accessories, you can organize your workspace more efficiently. Easy identification of parts, tools and accessories boosts your team's efficiency, facilitates stock taking, increases productivity and prevents expensive tools from being misplaced or lost. Taking the time to organize things well can save you time and money.

ACCESSORIES	PRODUCT NO.	CATALOG PAGE
1"H label holders	RG51	p. 243
Labels for label holders	RG53	p. 243
1"H label holders with adhesive	RG52	p. 243
1 3/4"H label holders	RG54	p. 243
1 3/4"H label holders with adhesive	RG55	p. 243
Handle protector	RF70	p. 243
Handle labels	RF71	p. 243
Vinyl rub-on identification decal	WM91-01J	p. 98

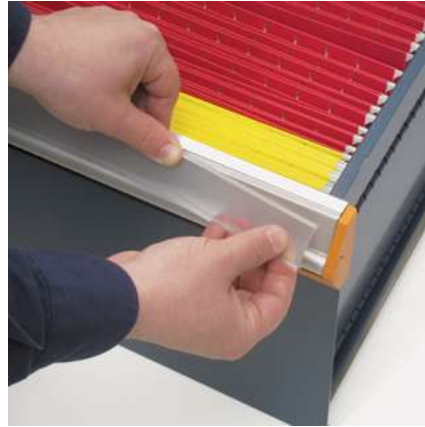

## DRAWER ACCESSORIES



We offer a wide variety of drawer accessories that integrate with each other to help you organize and locate small parts. They are ideal for high-density storage and ensure you retain space for growth.

ACCESSORIES	PRODUCT NO.	CATALOG PAGE
Front to back partition	RG00	p. 242
Side to side partition	RG01	p. 242
Divider	RG10	p. 242
Plastic bins	RG20	p. 245
Divider for plastic bins	RG22/RG24	p. 245
Groove tray	RG35	p. 245
Divider for groove trays	RG39	p. 245
Tool foam	RG42	p. 244

## PLASTIC BIN



RG20



- For easier storing, moving and managing of small parts Lightweight and durable
- 45° angled rim for easy identification of bin contents and removal of bins
- Compatible with WM55, WM5C and RC04 plastic bin panels, and WM28 / WM9C plastic bin rails
- 6" plastic bins can be subdivided

DIMENSIONS			PRODUCT NO.		
W	D	H	BIN	PARTITION	DIVIDER
3"	3"	2"	RG20-030302	-	-
4"	3"	2"	RG20-040302	-	-
6"	3"	2"	RG20-060302	RG22-0302	-
6"	6"	2"	RG20-060602	RG22-0602	RG24-0602
3"	3"	3"	RG20-030303	-	-
4"	3"	3"	RG20-040303	-	-
6"	3"	3"	RG20-060303	RG22-0303	-
6"	6"	3"	RG20-060603	RG22-0603	RG24-0603

NOTE: Height 2" = 1 1/2" real  
Height 3" = 2 1/2" real

WALL-MOUNTED WORKSTATIONS

WALL-MOUNTED WORKBENCH WITH WALL-MOUNTED CABINET



R5WH5-6010

DIMENSIONS		TYPE OF TOP			
W	D	PAINTED STEEL	STAINLESS STEEL	LAMINATED HARDWOOD	PLASTIC LAMINATE
60"	30"	R5WH5-1010	R5WH5-6010	R5WH5-2010	R5WH5-3010

- 1 top of your choice
- 2 wall mounted open legs
- 2 leg crossbars
- 1 shelf
- 2 wall cabinets

NOTE: The leg height is 28" and top thickness is 1 1/4".

WALL-MOUNTED OPEN LEG

WS95



- Load capacity: 500lb. per leg, 1,000lb. per pair (if wall and wall anchoring are of sufficient strength)
- Anchoring hardware not provided by Rousseau
- Intended for 24"D, 30"D and 36"D tops
- Compatible with all types of top available from Rousseau
- Compatible with WS18 back stops, WM10 uprights and WM11 bench frame
- WS96 crossbars and a 12"D WS50 shelf (optional add-on) can be installed on this product

PRODUCT NO.	D x H
WS95-2428	22 3/8" x 29 7/16"

CROSSBAR FOR WALL-MOUNTED LEG

WS96



- For installation of a 12"D WS50 shelf between two WS95 wall-mounted legs

PRODUCT NO.	DEPTH
WS96-24	13 3/4"



INDEX	PAGE(S)
Modular Drawer	218-223
Preconfigured Models . . .	224-241
Accessories . . . . .	242-247

## ROUSSEAU DRAWERS : BEST IN CLASS

### THE STURDIEST AND MOST DURABLE ON THE MARKET

Tested in an independent laboratory, Rousseau's modular drawer has demonstrated its superiority on many levels: loaded to full capacity, it completed a high number of cycles without showing any signs of wear. The Rousseau drawer reigns supreme in its category. Its superior performance and lifespan are a product of its durable and sturdy construction. In fact, we are so confident in its durability that we proudly offer a Lifetime Warranty on the drawer rolling mechanism – a promise worth investing in!

### A WIDE VARIETY OF ACCESSORIES

Rousseau drawers make your work easier: the many accessories available are all compatible with each other and help to keep your workspace organized and optimized. These accessories can also be easily rearranged according to your needs, and this extra convenience further boosts your productivity.

### STREAMLINED DESIGN

In addition to being sturdy and functional, Rousseau drawers have an attractive design. They look equally at home in an office or a factory, so you can create a harmonious and aesthetically pleasing workspace. The unique design of the R drawer is a trademark of Rousseau Metal Inc.



**LIFETIME WARRANTY**  
The Rousseau drawer rolling mechanism is covered by a lifetime warranty.



## THE ROUSSEAU DIFFERENCE



Supporting a 400 lb. load, the drawer can be opened thousands of times without showing signs of wear.



10 drawer heights

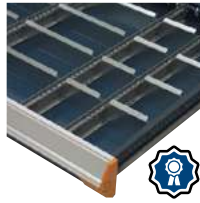

Partitions and dividers are clipped in



Rousseau name embossed on the front of each drawer. If you don't see ROUSSEAU, it's not a ROUSSEAU.

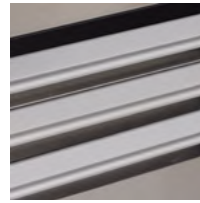

Stainless steel drawer fronts give high-class aesthetics to your cabinets and shelving. Excellent chemical and corrosion resistance.

## SMALL DETAILS THAT MAKE A BIG IMPACT

### ERGONOMIC

The full-width handle and accessories (integrated lock-in mechanism, lock-out mechanism, lock, etc.) have all been designed down to the smallest detail to make your work tasks easier.

### EFFICIENT

A wide range of accessories, such as partitions and dividers, plastic bins, groove trays, tool foam and hanging file bars help you to optimize your space for optimum efficiency.

### ACCESSIBLE

Drawers open 100% so you have full and unrestricted access to the contents.

### HEAVY-DUTY

400lb. load capacity per drawer.

### DURABLE

Our designers have created such a durable drawer that we proudly offer a Lifetime Warranty on the drawer rolling mechanism.

### INGENIOUS

Accessories can be added or removed at any time.



R5AEE-5825



R5SEE-874803

## 22 DRAWER SIZES × 10 HEIGHTS = 220 DIMENSIONS AVAILABLE

18" W



24" W



30" W

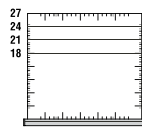

36" W

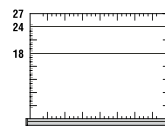

42" W

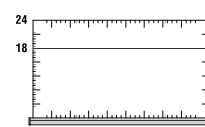

48" W

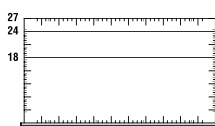

54" W

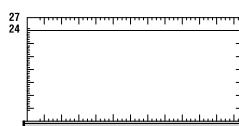

60" W

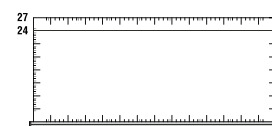

NOTE: The unique design of the R drawer is a trademark of Rousseau Metal Inc.

# MODULAR DRAWER

## MODULAR DRAWERS AND ROLL-OUT SHELVES

### HEAVY-DUTY MODULAR DRAWER



- Painted steel drawer for cabinets (and multi-drawer cabinets): RF31
- Painted steel drawer for shelving: RF32
- Drawer with stainless steel front and gray painted steel interior for cabinets (and multi-drawer cabinets): RF35
- Drawer with stainless steel front and gray painted steel interior for shelving: RF36
- 400lb. load capacity, 100% extension
- Heavy-duty construction
- Easy to install
- Vast choice of accessories available to customize the drawer to your storage needs, [see pages 242-247](#)
- Drawer heights available: 3", 4", 5", 6", 7", 8", 9", 10", 12" and 14"
- To order: Add the drawer height to the product number.
- For preconfigured modular drawers with compartments, [see pages 224-241](#)

### HEAVY-DUTY FRONT-ACCESS ROLL-OUT SHELF



- Roll-out shelf for cabinets (and multi-drawer cabinets): RF40
- Roll-out shelf for shelving: RF41
- 400lb. load capacity, 100% extension
- Heavy-duty construction
- Easy to install
- Painted steel with 3"H edges on the sides and back
- Total height: 6"
- Full access to contents

### HEAVY-DUTY 3-SIDED-ACCESS ROLL-OUT SHELF



- 3-sided-access roll-out shelf for cabinets (and multi-drawer cabinets): RF44
- 3-sided-access roll-out shelf for shelving: RF45
- 400lb. load capacity, 100% extension
- Heavy-duty construction
- Easy to install
- Galvanized steel with 1½"H back edge
- Total height: 5"
- Can be used as a work surface

#### IMPORTANT

For available dimensions according to use (cabinet or shelving), [see pages 221-222.](#)

## DRAWER AND ROLL-OUT SHELF DIMENSIONS

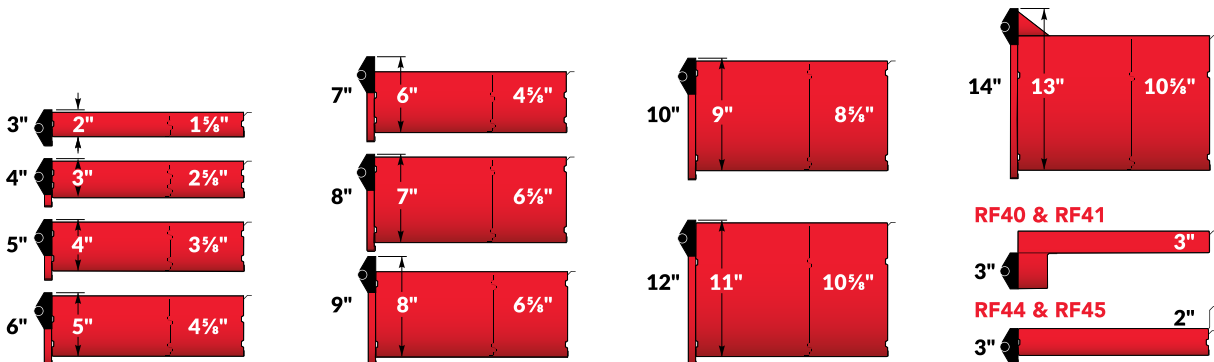

**18" x 21"**

**CABINET**  
 RF31-1821 \_\_  
 RF35-1821 \_\_  
 RF40-1821  
 RF44-1821

**18" x 24"**

**MULTI-DRAWER**  
 See pages  
 66-75

**18" x 27"**

**CABINET**  
 RF31-1827 \_\_  
 RF35-1827 \_\_  
 RF40-1827  
 RF44-1827

**MULTI-DRAWER**  
 See pages  
 66-75

**24" x 21"**

**CABINET**  
 RF31-2421 \_\_  
 RF35-2421 \_\_  
 RF40-2421  
 RF44-2421

**24" x 24"**

**MULTI-DRAWER**  
 See pages  
 66-75

**24" x 27"**

**CABINET**  
 RF31-2427 \_\_  
 RF35-2427 \_\_  
 RF40-2427  
 RF44-2427

**MULTI-DRAWER**  
 See pages  
 66-75

**30" x 18"**

**SHELVING**  
 RF32-3018 \_\_  
 RF36-3018 \_\_  
 RF41-3018  
 RF45-3018

**30" x 21"**

**CABINET**  
 RF31-3021 \_\_  
 RF35-3021 \_\_  
 RF40-3021  
 RF44-3021

**30" x 24"**

**SHELVING**  
 RF32-3024 \_\_  
 RF36-3024 \_\_  
 RF41-3024  
 RF45-3024

**MULTI-DRAWER**  
 See pages  
 66-75

**30" x 27"**

**CABINET**  
 RF31-3027 \_\_  
 RF35-3027 \_\_  
 RF40-3027  
 RF44-3027

**MULTI-DRAWER**  
 See pages  
 66-75

**36" x 18"**

**CABINET**  
 RF31-3618 \_\_  
 RF35-3618 \_\_  
 RF40-3618  
 RF44-3618

**SHELVING**  
 RF32-3618 \_\_  
 RF36-3618 \_\_  
 RF41-3618  
 RF45-3618

**36" x 24"**

**CABINET**  
 RF31-3624 \_\_  
 RF35-3624 \_\_  
 RF40-3624  
 RF44-3624

**SHELVING**  
 RF32-3624 \_\_  
 RF36-3624 \_\_  
 RF41-3624  
 RF45-3624

**MULTI-DRAWER**  
 See pages  
 66-75

**36" x 27"**

**CABINET**  
 RF31-3627 \_\_  
 RF35-3627 \_\_  
 RF40-3627  
 RF44-3627

**MULTI-DRAWER**  
 See pages  
 66-75

# MODULAR DRAWER

42" x 18"

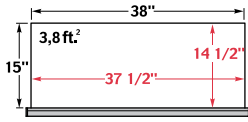

**SHELVING**

- RF32-4218 \_\_
- RF36-4218 \_\_
- RF41-4218
- RF45-4218

42" x 24"

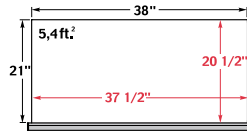

**SHELVING**

- RF32-4224 \_\_
- RF36-4224 \_\_
- RF41-4224
- RF45-4224



R5KKE-4403

48" x 18"

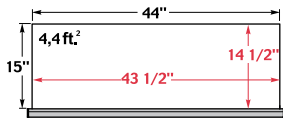

**SHELVING**

- RF32-4818 \_\_
- RF36-4818 \_\_
- RF41-4818
- RF45-4818

48" x 24"

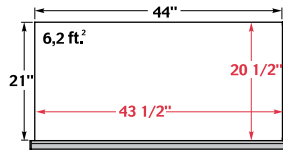

**CABINET**

- RF31-4824 \_\_
- RF35-4824 \_\_
- RF40-4824
- RF44-4824

**SHELVING**

- RF32-4824 \_\_
- RF36-4824 \_\_
- RF41-4824
- RF45-4824

**MULTI-DRAWER**

See pages  
66-75

48" x 27"

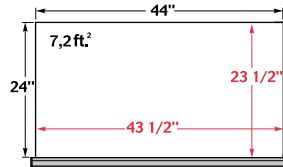

**CABINET**

- RF31-4827 \_\_
- RF35-4827 \_\_
- RF40-4827
- RF44-4827

**MULTI-DRAWER**

See pages  
66-75

54" x 24"

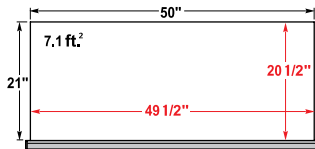

**CABINET**

- RF31-5424 \_\_
- RF35-5424 \_\_
- RF40-5424
- RF44-5424

**MULTI-DRAWER**

See pages  
66-75

54" x 27"

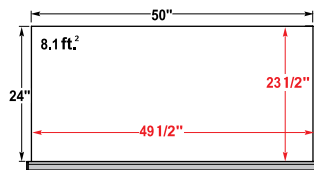

**CABINET**

- RF31-5427 \_\_
- RF35-5427 \_\_
- RF40-5427
- RF44-5427

**MULTI-DRAWER**

See pages  
66-75

60" x 24"

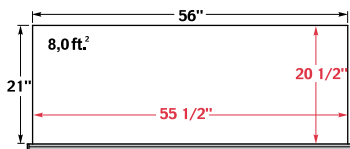

**CABINET**

- RF31-6024 \_\_
- RF35-6024 \_\_
- RF40-6024
- RF44-6024

**MULTI-DRAWER**

See pages  
66-75

60" x 27"

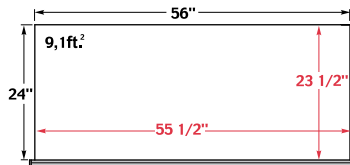

**CABINET**

- RF31-6027 \_\_
- RF35-6027 \_\_
- RF40-6027
- RF44-6027

**MULTI-DRAWER**

See pages  
66-75

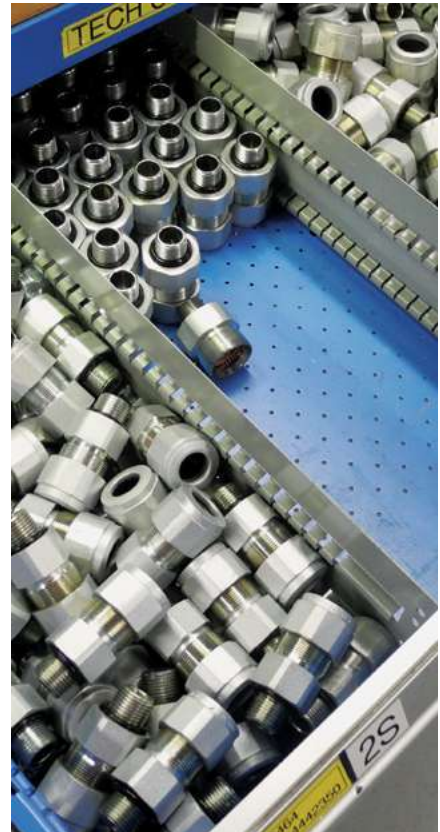



## HOW TO ORDER A DRAWER

### CHOOSE DRAWERS FROM OUR SELECTION OF PRECONFIGURED COMPARTMENT LAYOUTS

- 00 for subdividing kit only
- 51 for a painted steel drawer for cabinets – with compartments
- 52 for a painted steel drawer for shelving – with compartments
- See pages 224-241

R EE-A0200

Drawer height, see page 220

Locking or security mechanism, see page 247

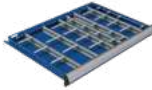

e.g., R52EE-A020006 L3A

For a 36"W x 24"D painted steel drawer for shelving with compartments, 6"H drawer, an L3 lock on the drawer and integrated lock-in mechanism

### CREATE A CUSTOM MODEL BY CHOOSING AN EMPTY DRAWER AND ADDING SUBDIVIDING ACCESSORIES

- 31 for a painted steel drawer for cabinets
- 32 for a painted steel drawer for shelving
- 35 for a drawer for cabinets with stainless steel front
- 36 for a drawer for shelving with stainless steel front

RF - 3624

Drawer height, see page 220

Locking or security mechanism, see page 247



e.g., RF31-362406 L3A

For a 36" W x 24" D painted steel drawer for cabinets, 6"H drawer, an L3 lock on the drawer and integrated lock-in mechanism

NOTE: Accessories must be ordered separately, see pages 242-247.

### TO CALCULATE DRAWER COMPARTMENT DIMENSIONS, REFER TO THE FOLLOWING ILLUSTRATION

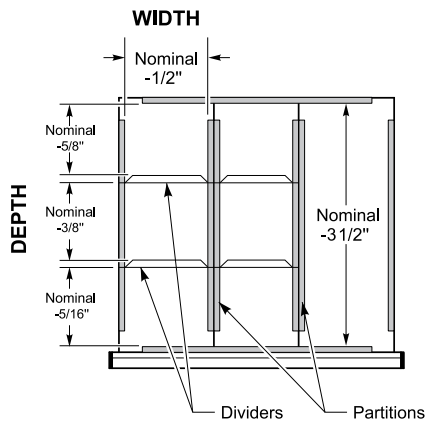

### DRAWER DIMENSIONS

		INSIDE WIDTH							
		14"	20"	26"	32"	38"	44"	50"	56"
OUTSIDE DEPTH	27"	18"x27"	24"x27"	30"x27"	36"x27"	48"x27"		54"x27"	60"x27"
	24"	18"x24"	24"x24"	30"x24"	36"x24"	42"x24"	48"x24"	54"x24"	60"x24"
INSIDE DEPTH	21"	18"x21"	24"x21"	30"x21"	42"x21"		48"x21"		
	18"			30"x18"	36"x18"	42"x18"	48"x18"		
		OUTSIDE WIDTH							
		24"	30"	36"	42"	48"	54"	60"	

## HOW TO ORDER A ROLL-OUT SHELF

### COMPLETE THE FIRST PART OF THE PRODUCT NUMBER WITH THE TYPE OF ROLL-OUT SHELF REQUIRED

- 40 for a roll-out shelf for cabinets
- 41 for a roll-out shelf for shelving
- 44 for a 3-sided-access roll-out shelf for cabinets
- 45 for a 3-sided-access roll-out shelf for shelving

RF - 3624

Locking or security mechanism, see page 247

e.g., RF41-3624A

For a roll-out shelf for shelving with an integrated lock-in mechanism



R5XEE-2002

# PRECONFIGURED MODELS

## 18"W x 21"D DRAWER – CABINETS

### PARTITIONS AND DIVIDERS

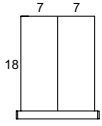

R\_\_BD-A0100\_\_  
2 COMPARTMENTS

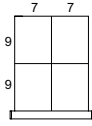

R\_\_BD-A0102\_\_  
4 COMPARTMENTS

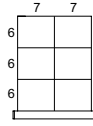

R\_\_BD-A0104\_\_  
6 COMPARTMENTS

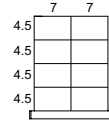

R\_\_BD-A0106\_\_  
8 COMPARTMENTS

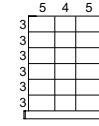

R\_\_BD-A0215\_\_  
18 COMPARTMENTS

### PLASTIC BINS<sup>2</sup>

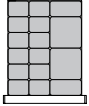

R\_\_BD-E016\_\_  
16 BINS

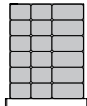

R\_\_BD-E018\_\_  
18 BINS

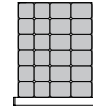

R\_\_BD-E024\_\_  
24 BINS

### FOAM<sup>2</sup>



R\_\_BD-J01\_\_  
PROTECTIVE FOAM



R\_\_BD-J02\_\_  
TOOL FOAM



### GROOVE TRAYS<sup>1,2</sup>

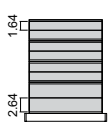

R\_\_BD-TD08\_\_  
8 GROOVE TRAYS

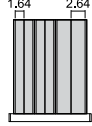

R\_\_BD-TW06\_\_  
6 GROOVE TRAYS

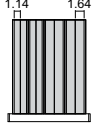

R\_\_BD-TW08\_\_  
8 GROOVE TRAYS

### HANGING FILE BARS<sup>3</sup>

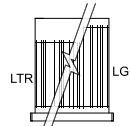

R\_\_BD-KLR\_\_  
WIDTH

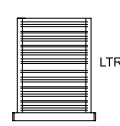

R\_\_BD-KFB\_\_  
DEPTH

## 18"W x 24"D DRAWER – MULTI-DRAWER

### PARTITIONS AND DIVIDERS

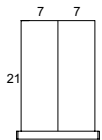

R\_\_BE-A0100\_\_  
2 COMPARTMENTS

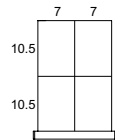

R\_\_BE-A0102\_\_  
4 COMPARTMENTS

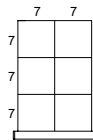

R\_\_BE-A0104\_\_  
6 COMPARTMENTS

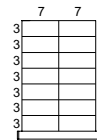

R\_\_BE-A0112\_\_  
14 COMPARTMENTS

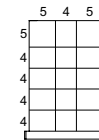

R\_\_BE-A0212\_\_  
15 COMPARTMENTS

### PLASTIC BINS<sup>2</sup>

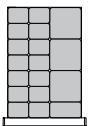

R\_\_BE-E018\_\_  
18 BINS

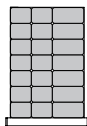

R\_\_BE-E021\_\_  
21 BINS

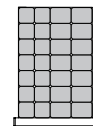

R\_\_BE-E028\_\_  
28 BINS

### FOAM<sup>2</sup>



R\_\_BE-J01\_\_  
PROTECTIVE FOAM

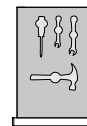

R\_\_BE-J02\_\_  
TOOL FOAM



### GROOVE TRAYS<sup>1,2</sup>

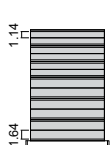

R\_\_BE-TD12\_\_  
12 GROOVE TRAYS

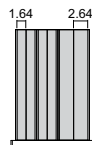

R\_\_BE-TW06\_\_  
6 GROOVE TRAYS

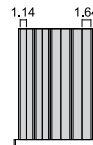

R\_\_BE-TW08\_\_  
8 GROOVE TRAYS

### HANGING FILE BARS<sup>3</sup>

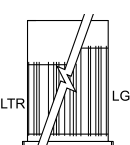

R\_\_BE-KFB\_\_  
WIDTH

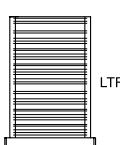

R\_\_BE-KLR\_\_  
DEPTH

NOTES: <sup>1</sup> Two dividers included with each groove. <sup>2</sup> Available for 3"H and 4"H drawers. <sup>3</sup> Available for 12"H and 14"H drawers.

## 18"W x 27"D DRAWERS – CABINETS / MULTI-DRAWER

### PARTITIONS AND DIVIDERS

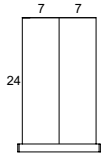

R\_\_BG-A0100\_\_  
2 COMPARTMENTS

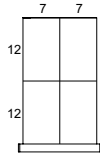

R\_\_BG-A0102\_\_  
4 COMPARTMENTS

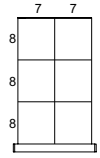

R\_\_BG-A0104\_\_  
6 COMPARTMENTS

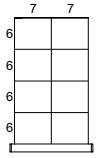

R\_\_BG-A0106\_\_  
8 COMPARTMENTS

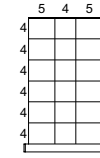

R\_\_BG-A0215\_\_  
18 COMPARTMENTS

### PLASTIC BINS<sup>2</sup>

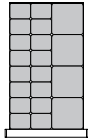

R\_\_BG-E020\_\_  
20 BINS

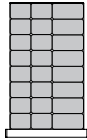

R\_\_BG-E024\_\_  
24 BINS

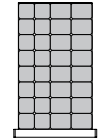

R\_\_BG-E032\_\_  
32 BINS

### FOAM<sup>2</sup>

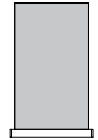

R\_\_BG-J01\_\_  
PROTECTIVE FOAM

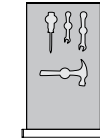

R\_\_BG-J02\_\_  
TOOL FOAM



### GROOVE TRAYS<sup>1,2</sup>

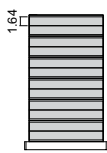

R\_\_BG-TD12\_\_  
12 GROOVE TRAYS

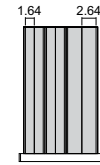

R\_\_BG-TW06\_\_  
6 GROOVE TRAYS

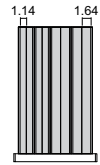

R\_\_BG-TW08\_\_  
8 GROOVE TRAYS

### HANGING FILE BARS<sup>3</sup>

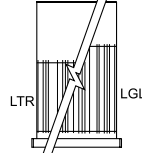

R\_\_BG-KLR\_\_  
WIDTH

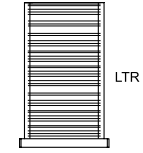

R\_\_BG-KFB\_\_  
DEPTH

## 24"W x 21"D DRAWERS – CABINETS

### PARTITIONS AND DIVIDERS

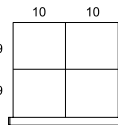

R\_\_CD-A0102\_\_  
4 COMPARTMENTS

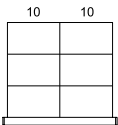

R\_\_CD-A0104\_\_  
6 COMPARTMENTS

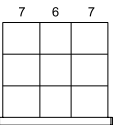

R\_\_CD-A0206\_\_  
9 COMPARTMENTS

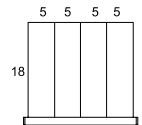

R\_\_CD-A0300\_\_  
4 COMPARTMENTS

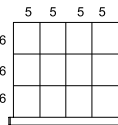

R\_\_CD-A0308\_\_  
12 COMPARTMENTS

### PLASTIC BINS<sup>2</sup>

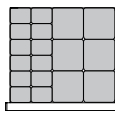

R\_\_CD-E018\_\_  
18 BINS

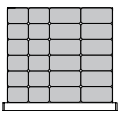

R\_\_CD-E024\_\_  
24 BINS

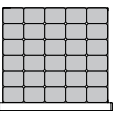

R\_\_CD-E030\_\_  
30 BINS

### FOAM<sup>2</sup>



R\_\_CD-J01\_\_  
PROTECTIVE FOAM

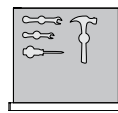

R\_\_CD-J02\_\_  
TOOL FOAM



### GROOVE TRAYS<sup>1,2</sup>

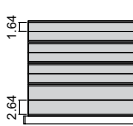

R\_\_CD-TD08\_\_  
8 GROOVE TRAYS

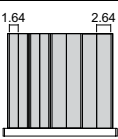

R\_\_CD-TW08\_\_  
8 GROOVE TRAYS

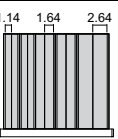

R\_\_CD-TW10\_\_  
10 GROOVE TRAYS

### HANGING FILE BARS<sup>3</sup>



R\_\_CD-KLR\_\_  
WIDTH

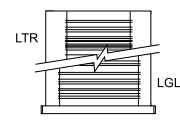

R\_\_CD-KFB\_\_  
DEPTH

NOTES: <sup>1</sup> Two dividers included with each groove. <sup>2</sup> Available for 3"H and 4"H drawers. <sup>3</sup> Available for 12"H and 14"H drawers.

# PRECONFIGURED MODELS

## 24"W x 24"D DRAWERS – MULTI-DRAWER

### PARTITIONS AND DIVIDERS

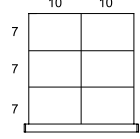
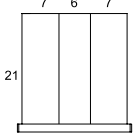
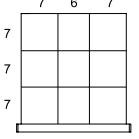
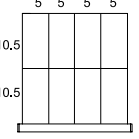
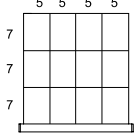
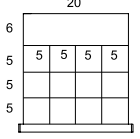
 <p>R__CE-A0104__ 6 COMPARTMENTS</p>	 <p>R__CE-A0200__ 3 COMPARTMENTS</p>	 <p>R__CE-A0206__ 9 COMPARTMENTS</p>	 <p>R__CE-A0304__ 8 COMPARTMENTS</p>	 <p>R__CE-A0308__ 12 COMPARTMENTS</p>	 <p>R__CE-C0408__ 13 COMPARTMENTS</p>
---	---	---	---	--	--

### PLASTIC BINS<sup>2</sup>

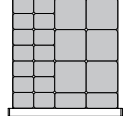
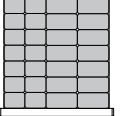
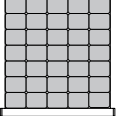
 <p>R__CE-E022__ 22 BINS</p>	 <p>R__CE-E028__ 28 BINS</p>	 <p>R__CE-E035__ 35 BINS</p>
---	---	---

### FOAM<sup>2</sup>

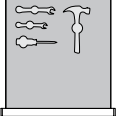
 <p>R__CE-J01__ PROTECTIVE FOAM</p>	 <p>R__CE-J02__ TOOL FOAM</p>
--	--

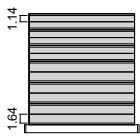
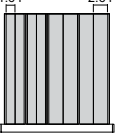
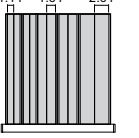

### GROOVE TRAYS<sup>1,2</sup>

 <p>R__CE-TD120__ 12 GROOVE TRAYS</p>	 <p>R__CE-TW08__ 8 GROOVE TRAYS</p>	 <p>R__CE-TW10__ 10 GROOVE TRAYS</p>
--	--	---

### HANGING FILE BARS<sup>3</sup>

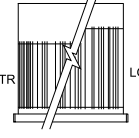
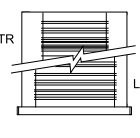
 <p>R__CE-KLR__ WIDTH</p>	 <p>R__CE-KFB__ DEPTH</p>
--	--

NOTES: <sup>1</sup>Two dividers included with each groove. <sup>2</sup> Available for 3"H and 4"H drawers. <sup>3</sup> Available for 12"H and 14"H drawers.



## 24"W x 27"D DRAWERS – CABINETS / MULTI-DRAWER

### PARTITIONS AND DIVIDERS

R__CG-A0104__ 6 COMPARTMENTS	R__CG-A0206__ 9 COMPARTMENTS	R__CG-A0209__ 12 COMPARTMENTS	R__CG-A0308__ 12 COMPARTMENTS	R__CG-A0312__ 16 COMPARTMENTS	R__CG-A0316__ 20 COMPARTMENTS

### PLASTIC BINS<sup>2</sup>

R__CG-E024__ 24 BINS	R__CG-E032__ 32 BINS	R__CG-E040__ 40 BINS

### FOAM<sup>2</sup>

R__CG-J01__ PROTECTIVE FOAM	R__CG-J02__ TOOL FOAM



### GROOVE TRAYS<sup>1,2</sup>

R__CG-TD10__ 10 GROOVE TRAYS	R__CG-TW08__ 8 GROOVE TRAYS	R__CG-TW10__ 10 GROOVE TRAYS

### HANGING FILE BARS<sup>3</sup>

R__CG-KLR__ WIDTH	R__CG-KFB__ DEPTH

## 30"W x 18"D DRAWERS – SHELVING

### PARTITIONS AND DIVIDERS

R__DC-A0102__ 4 COMPARTMENTS	R__DC-A0308__ 12 COMPARTMENTS	R__DC-A0512__ 18 COMPARTMENTS	R__DC-A0414__ 19 COMPARTMENTS	R__DC-A0418__ 23 COMPARTMENTS

### PLASTIC BINS<sup>2</sup>

R__DC-E019__ 19 BINS	R__DC-E025__ 25 BINS	R__DC-E035__ 35 BINS

### FOAM<sup>2</sup>

R__DC-J01__ PROTECTIVE FOAM	R__DC-J02__ TOOL FOAM



### GROOVE TRAYS<sup>1,2</sup>

R__DC-TD08__ 8 GROOVE TRAYS	R__DC-TW10__ 10 GROOVE TRAYS	R__DC-TW12__ 12 GROOVE TRAYS	R__DC-TW14__ 14 GROOVE TRAYS

### HANGING FILE BARS<sup>3</sup>

R__DC-KLR__ WIDTH	R__DC-KFB__ DEPTH

NOTES: <sup>1</sup> Two dividers included with each groove. <sup>2</sup> Available for 3"H and 4"H drawers. <sup>3</sup> Available for 12"H and 14"H drawers.

# PRECONFIGURED MODELS

## 30"W x 21"D DRAWERS – CABINETS

### PARTITIONS AND DIVIDERS

R_DD-A0102_	R_DD-A0203_	R_DD-A0206_	R_DD-A0308_	R_DD-A0518_	R_DD-D0411_
4 COMPARTMENTS	6 COMPARTMENTS	9 COMPARTMENTS	12 COMPARTMENTS	24 COMPARTMENTS	16 COMPARTMENTS

### PLASTIC BINS<sup>2</sup>

R_DD-E021_	R_DD-E030_	R_DD-E036_
21 BINS	30 BINS	36 BINS

### FOAM<sup>2</sup>

R_DD-J01_	R_DD-J02_	Sold without cut-outs
PROTECTIVE FOAM	TOOL FOAM	

### GROOVE TRAYS<sup>1</sup>

R_DD-TD08_	R_DD-TW10_	R_DD-TW12_	R_DD-TW14_
8 GROOVE TRAYS	10 GROOVE TRAYS	12 GROOVE TRAYS	14 GROOVE TRAYS

### HANGING FILE BARS<sup>3</sup>

R_DD-KLR_	R_DD-KFB_
WIDTH	DEPTH

## 30"W x 24"D DRAWERS – SHELVING / MULTI-DRAWER

### PARTITIONS AND DIVIDERS

R_DE-A0102_	R_DE-A0206_
4 COMPARTMENTS	9 COMPARTMENTS
R_DE-A0300_	R_DE-A0308_
4 COMPARTMENTS	12 COMPARTMENTS
R_DE-A0524_	R_DE-B0200_
30 COMPARTMENTS	3 COMPARTMENTS
R_DE-C0408_	R_DE-D0527_
13 COMPARTMENTS	33 COMPARTMENTS

### PLASTIC BINS<sup>2</sup>

R_DE-E026_	R_DE-E035_	R_DE-E042_
26 BINS	35 BINS	42 BINS

### FOAM<sup>2</sup>

R_DE-J01_	R_DE-J02_	R_DE-J03_
PROTECTIVE FOAM	TOOL FOAM	COLLET FOAM

### GROOVE TRAYS<sup>1,2</sup>

R_DE-TD12_	R_DE-TW10_
12 GROOVE TRAYS	10 GROOVE TRAYS
R_DE-TW12_	R_DE-TW14_
12 GROOVE TRAYS	14 GROOVE TRAYS

### HANGING FILE BARS<sup>3</sup>

R_DE-KLR_	R_DE-KFB_
WIDTH	DEPTH

Sold without cut-outs

NOTES: <sup>1</sup> Two dividers included with each groove. <sup>2</sup> Available for 3"H and 4"H drawers. <sup>3</sup> Available for 12"H and 14"H drawers.

## 30"W x 27"D DRAWERS – CABINETS / MULTI-DRAWER

### PARTITIONS AND DIVIDERS

R_DG-A0102_	R_DG-A0203_	R_DG-A0206_	R_DG-A0300_
4 COMPARTMENTS	6 COMPARTMENTS	9 COMPARTMENTS	4 COMPARTMENTS
R_DG-C0410_	R_DG-A0304_	R_DG-A0308_	R_DG-A0312_
15 COMPARTMENTS	8 COMPARTMENTS	12 COMPARTMENTS	16 COMPARTMENTS
R_DG-A0316_	R_DG-D0207_	R_DG-A0420_	R_DG-A0425_
20 COMPARTMENTS	10 COMPARTMENTS	25 COMPARTMENTS	30 COMPARTMENTS
R_DG-A0518_	R_DG-A0524_	R_DG-D0312_	R_DG-A0530_
24 COMPARTMENTS	30 COMPARTMENTS	16 COMPARTMENTS	36 COMPARTMENTS
R_DG-A0724_	R_DG-A0732_	R_DG-A0740_	
32 COMPARTMENTS	40 COMPARTMENTS	48 COMPARTMENTS	

### GROOVE TRAYS<sup>1,2</sup>

R_DG-TD10_	R_DG-TW10_
10 GROOVE TRAYS	10 GROOVE TRAYS
R_DG-TW12_	R_DG-TW14_
12 GROOVE TRAYS	14 GROOVE TRAYS

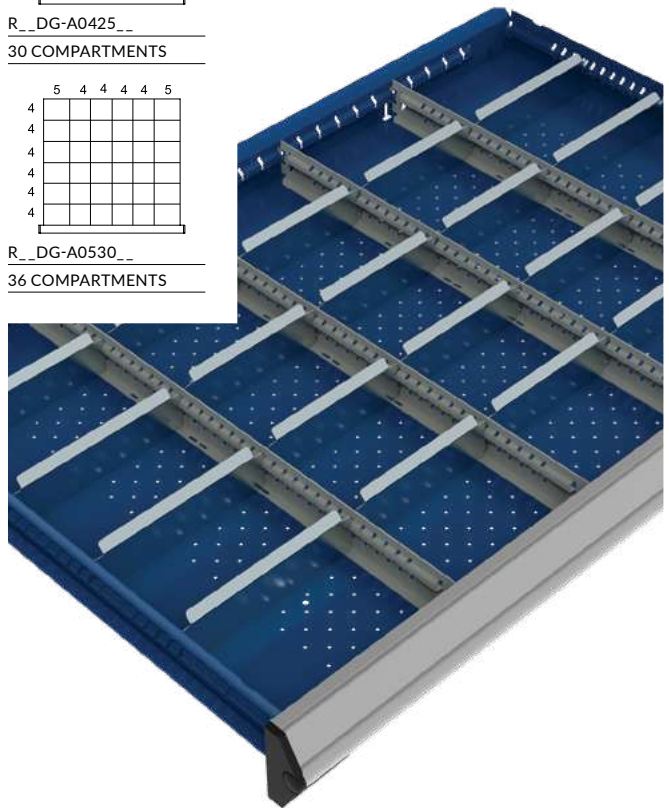

### PLASTIC BINS<sup>2</sup>

R_DG-E028_	R_DG-E040_	R_DG-E048_
28 BINS	40 BINS	48 BINS

### FOAM<sup>2</sup>

R_DG-J01_	R_DG-J02_	R_DG-J03_
PROTECTIVE FOAM	TOOL FOAM	COLLET FOAM



### HANGING FILE BARS<sup>3</sup>

R_DG-KLR_	R_DG-KFB_
WIDTH	DEPTH

NOTES: <sup>1</sup> Two dividers included with each groove. <sup>2</sup> Available for 3"H and 4"H drawers. <sup>3</sup> Available for 12"H and 14"H drawers.

# PRECONFIGURED MODELS

## 36"W x 18"D DRAWERS – CABINETS / SHELVING

### PARTITIONS AND DIVIDERS

R_EC-A0200_	R_EC-A0203_	R_EC-A0206_	R_EC-A0209_	R_EC-A0300_	R_EC-A0304_
3 COMPARTMENTS	6 COMPARTMENTS	9 COMPARTMENTS	12 COMPARTMENTS	4 COMPARTMENTS	8 COMPARTMENTS
R_EC-A0308_	R_EC-A0312_	R_EC-A0400_	R_EC-A0405_	R_EC-A0410_	R_EC-A0415_
12 COMPARTMENTS	16 COMPARTMENTS	5 COMPARTMENTS	10 COMPARTMENTS	15 COMPARTMENTS	20 COMPARTMENTS
R_EC-A0500_	R_EC-A0506_	R_EC-A0512_	R_EC-A0518_	R_EC-A0524_	R_EC-A0700_
6 COMPARTMENTS	12 COMPARTMENTS	18 COMPARTMENTS	24 COMPARTMENTS	30 COMPARTMENTS	8 COMPARTMENTS
R_EC-A0708_	R_EC-A0716_	R_EC-A0724_			
16 COMPARTMENTS	24 COMPARTMENTS	32 COMPARTMENTS			



### PLASTIC BINS<sup>2</sup>

R_EC-E022_	R_EC-E030_	R_EC-E040_
22 BINS	30 BINS	40 BINS

### FOAM<sup>2</sup>



R\_EC-J01\_  
PROTECTIVE FOAM

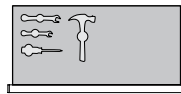

R\_EC-J02\_  
TOOL FOAM

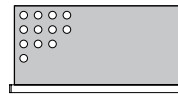

R\_EC-J03\_  
COLLET FOAM



### GROOVE TRAYS<sup>1,2</sup>

R_EC-TD08_	R_EC-TW12_	R_EC-TW16_
8 GROOVE TRAYS	12 GROOVE TRAYS	16 GROOVE TRAYS

### HANGING FILE BARS<sup>3</sup>

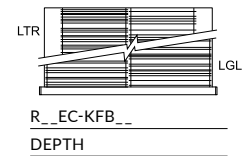

NOTES: <sup>1</sup> Two dividers included with each groove. <sup>2</sup> Available for 3"H and 4"H drawers. <sup>3</sup> Available for 12"H and 14"H drawers.



## 36"W x 24"D DRAWERS – CABINETS / SHELVING / MULTI-DRAWER

### PARTITIONS AND DIVIDERS

<p>R_ EE-A0200_</p> <p>3 COMPARTMENTS</p>	<p>R_ EE-A0203_</p> <p>6 COMPARTMENTS</p>	<p>R_ EE-A0206_</p> <p>9 COMPARTMENTS</p>	<p>R_ EE-A0209_</p> <p>12 COMPARTMENTS</p>	<p>R_ EE-A0300_</p> <p>4 COMPARTMENTS</p>
<p>R_ EE-A0308_</p> <p>12 COMPARTMENTS</p>	<p>R_ EE-A0312_</p> <p>16 COMPARTMENTS</p>	<p>R_ EE-A0316_</p> <p>20 COMPARTMENTS</p>	<p>R_ EE-A0405_</p> <p>10 COMPARTMENTS</p>	<p>R_ EE-A0410_</p> <p>15 COMPARTMENTS</p>
<p>R_ EE-A0724_</p> <p>32 COMPARTMENTS</p>	<p>R_ EE-A0420_</p> <p>25 COMPARTMENTS</p>	<p>R_ EE-A0512_</p> <p>18 COMPARTMENTS</p>	<p>R_ EE-A0518_</p> <p>24 COMPARTMENTS</p>	<p>R_ EE-A0524_</p> <p>30 COMPARTMENTS</p>
<p>R_ EE-A0732_</p> <p>40 COMPARTMENTS</p>	<p>R_ EE-A0740_</p> <p>48 COMPARTMENTS</p>	<p>R_ EE-C0404_</p> <p>9 COMPARTMENTS</p>	<p>R_ EE-B0200_</p> <p>3 COMPARTMENTS</p>	<p>R_ EE-B0300_</p> <p>4 COMPARTMENTS</p>

### PLASTIC BINS<sup>2</sup>

<p>R_ EE-D0409_</p> <p>14 COMPARTMENTS</p>	<p>R_ EE-D0416_</p> <p>21 COMPARTMENTS</p>	<p>R_ EE-E030_</p> <p>30 BINS</p>	<p>R_ EE-E042_</p> <p>42 BINS</p>	<p>R_ EE-E056_</p> <p>56 BINS</p>
--	--	-----------------------------------	-----------------------------------	-----------------------------------

### FOAM<sup>2</sup>

<p>R_ EE-J01_</p> <p>PROTECTIVE FOAM</p>	<p>R_ EE-J02_</p> <p>TOOL FOAM</p>	<p>R_ EE-J03_</p> <p>COLLET FOAM</p>	<p>Sold without cut-outs</p>
--	------------------------------------	--------------------------------------	------------------------------

### GROOVE TRAYS<sup>1,2</sup>

<p>R_ EE-TD10_</p> <p>10 GROOVE TRAYS</p>	<p>R_ EE-TW12_</p> <p>12 GROOVE TRAYS</p>	<p>R_ EE-TW16_</p> <p>16 GROOVE TRAYS</p>
---	---	---

### HANGING FILE BARS<sup>3</sup>

<p>R_ EE-KLR_</p> <p>WIDTH</p>	<p>R_ EE-KFB_</p> <p>DEPTH</p>
--------------------------------	--------------------------------

NOTES: <sup>1</sup> Two dividers included with each groove. <sup>2</sup> Available for 3"H and 4"H drawers. <sup>3</sup> Available for 12"H and 14"H drawers.

# PRECONFIGURED MODELS

## 36"W x 27"D DRAWERS – CABINETS / MULTI-DRAWER

### PARTITIONS AND DIVIDERS

<p>R__EG-A0203__ 6 COMPARTMENTS</p>	<p>R__EG-A0300__ 4 COMPARTMENTS</p>	<p>R__EG-A0308__ 12 COMPARTMENTS</p>	<p>R__EG-A0312__ 16 COMPARTMENTS</p>	<p>R__EG-A0415__ 20 COMPARTMENTS</p>
<p>R__EG-A0425__ 30 COMPARTMENTS</p>	<p>R__EG-A0512__ 18 COMPARTMENTS</p>	<p>R__EG-A0518__ 24 COMPARTMENTS</p>	<p>R__EG-A0524__ 30 COMPARTMENTS</p>	<p>R__EG-A0716__ 24 COMPARTMENTS</p>
<p>R__EG-A0724__ 32 COMPARTMENTS</p>	<p>R__EG-A0740__ 48 COMPARTMENTS</p>	<p>R__EG-B0200__ 3 COMPARTMENTS</p>	<p>R__EG-C0508__ 14 COMPARTMENTS</p>	<p>R__EG-D0309__ 13 COMPARTMENTS</p>

### PLASTIC BINS<sup>2</sup>

<p>R__EG-E032__ 32 BINS</p>	<p>R__EG-E048__ 48 BINS</p>	<p>R__EG-E064__ 64 BINS</p>
---------------------------------	---------------------------------	---------------------------------

### FOAM<sup>2</sup>

<p>R__EG-J01__ PROTECTIVE FOAM</p>	<p>R__EG-J02__ TOOL FOAM</p>	<p>Sold without cut-outs</p>
--	----------------------------------	------------------------------

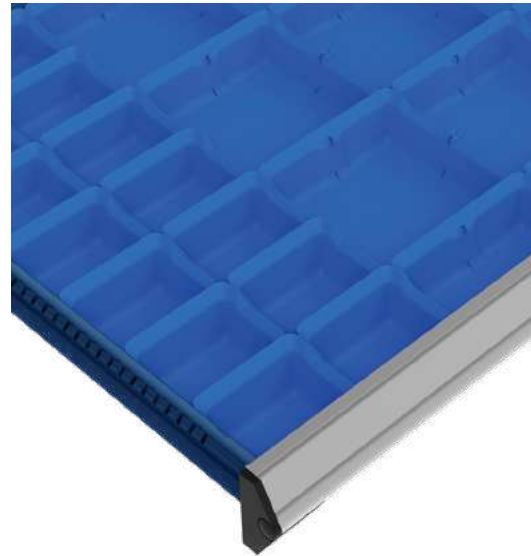

### GROOVE TRAYS<sup>1,2</sup>

<p>R__EG-TD12__ 12 GROOVE TRAYS</p>	<p>R__EG-TW12__ 12 GROOVE TRAYS</p>	<p>R__EG-TW16__ 16 GROOVE TRAYS</p>
---	---	---

### HANGING FILE BARS<sup>3</sup>

<p>R__EG-KLR__ WIDTH</p>	<p>R__EG-KFB__ DEPTH</p>
------------------------------	------------------------------

NOTES: <sup>1</sup> Two dividers included with each groove. <sup>2</sup> Available for 3"H and 4"H drawers. <sup>3</sup> Available for 12"H and 14"H drawers.

## 42"W x 18"D DRAWERS – SHELVING

### PARTITIONS AND DIVIDERS

<p>R_GC-A0203__ 6 COMPARTMENTS</p>	<p>R_GC-A0209__ 12 COMPARTMENTS</p>	<p>R_GC-A0304__ 8 COMPARTMENTS</p>	<p>R_GC-A0308__ 12 COMPARTMENTS</p>	<p>R_GC-A0405__ 10 COMPARTMENTS</p>
<p>R_GC-A0410__ 15 COMPARTMENTS</p>	<p>R_GC-A0415__ 20 COMPARTMENTS</p>	<p>R_GC-A0506__ 12 COMPARTMENTS</p>	<p>R_GC-A0512__ 18 COMPARTMENTS</p>	<p>R_GC-A0518__ 24 COMPARTMENTS</p>
<p>R_GC-A0708__ 16 COMPARTMENTS</p>	<p>R_GC-A0716__ 24 COMPARTMENTS</p>	<p>R_GC-A0724__ 32 COMPARTMENTS</p>	<p>R_GC-A0910__ 20 COMPARTMENTS</p>	<p>R_GC-A0930__ 40 COMPARTMENTS</p>

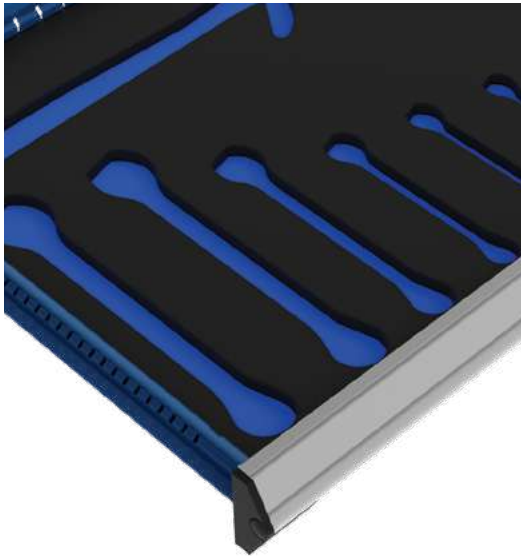

### PLASTIC BINS<sup>2</sup>

<p>R_GC-E025__ 25 BINS</p>	<p>R_GC-E035__ 35 BINS</p>	<p>R_GC-E045__ 45 BINS</p>
--------------------------------	--------------------------------	--------------------------------

### FOAM<sup>2</sup>

<p>R_GC-J01__ PROTECTIVE FOAM</p>	<p>R_GC-J02__ TOOL FOAM</p>	<p>Sold without cut-outs</p>
---------------------------------------	---------------------------------	------------------------------

### GROOVE TRAYS<sup>1,2</sup>

<p>R_GC-TD08__ 8 GROOVE TRAYS</p>	<p>R_GC-TW16__ 16 GROOVE TRAYS</p>	<p>R_GC-TW20__ 20 GROOVE TRAYS</p>
---------------------------------------	--	--

### HANGING FILE BARS<sup>3</sup>

<p>R_GC-KLR__ WIDTH</p>	<p>R_GC-KFB__ DEPTH</p>
-----------------------------	-----------------------------

NOTES: <sup>1</sup> Two dividers included with each groove. <sup>2</sup> Available for 3"H and 4"H drawers. <sup>3</sup> Available for 12"H and 14"H drawers.

# PRECONFIGURED MODELS

## 42"W x 24"D DRAWERS – SHELVING

### PARTITIONS AND DIVIDERS

<p>R_GE-A0203__ 6 COMPARTMENTS</p>	<p>R_GE-A0212__ 15 COMPARTMENTS</p>	<p>R_GE-A0304__ 8 COMPARTMENTS</p>	<p>R_GE-A0308__ 12 COMPARTMENTS</p>
<p>R_GE-A0316__ 20 COMPARTMENTS</p>	<p>R_GE-A0415__ 20 COMPARTMENTS</p>	<p>R_GE-A0420__ 25 COMPARTMENTS</p>	<p>R_GE-A0512__ 18 COMPARTMENTS</p>
<p>R_GE-A0524__ 30 COMPARTMENTS</p>	<p>R_GE-A0716__ 24 COMPARTMENTS</p>	<p>R_GE-A0732__ 40 COMPARTMENTS</p>	<p>R_GE-A0910__ 20 COMPARTMENTS</p>
<p>R_GE-A0920__ 30 COMPARTMENTS</p>	<p>R_GE-C0408__ 13 COMPARTMENTS</p>	<p>R_GE-D0517__ 23 COMPARTMENTS</p>	

### FOAM<sup>2</sup>

<p>R_GE-J01__ PROTECTIVE FOAM</p>	<p>R_GE-J02__ TOOL FOAM</p>
---------------------------------------	---------------------------------

**Sold without cut-outs**

### HANGING FILE BARS<sup>3</sup>

<p>R_GE-KLR__ WIDTH</p>
-----------------------------

### PLASTIC BINS<sup>2</sup>

<p>R_GE-E034__ 34 BINS</p>	<p>R_GE-E049__ 49 BINS</p>	<p>R_GE-E063__ 63 BINS</p>	<p>R_GE-KFB__ DEPTH</p>
--------------------------------	--------------------------------	--------------------------------	-----------------------------

### GROOVE TRAYS<sup>1,2</sup>

<p>R_GE-TD10__ 10 GROOVE TRAYS</p>	<p>R_GE-TW16__ 16 GROOVE TRAYS</p>	<p>R_GE-TW20__ 20 GROOVE TRAYS</p>
--	--	--

NOTES: <sup>1</sup>Two dividers included with each groove. <sup>2</sup> Available for 3"H and 4"H drawers. <sup>3</sup> Available for 12"H and 14"H drawers.

## 48"W x 18"D DRAWERS – SHELVING

### PARTITIONS AND DIVIDERS

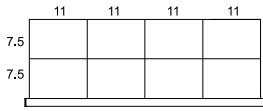

R\_HC-A0304\_\_  
8 COMPARTMENTS

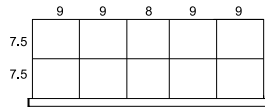

R\_HC-A0405\_\_  
10 COMPARTMENTS

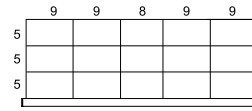

R\_HC-A0410\_\_  
15 COMPARTMENTS

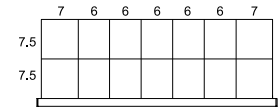

R\_HC-A0607\_\_  
14 COMPARTMENTS

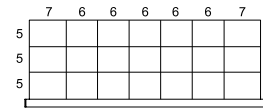

R\_HC-A0614\_\_  
21 COMPARTMENTS

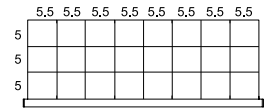

R\_HC-A0716\_\_  
24 COMPARTMENTS

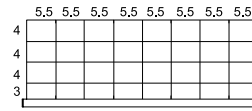

R\_HC-A0724\_\_  
32 COMPARTMENTS

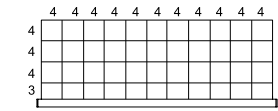

R\_HC-A1033\_\_  
44 COMPARTMENTS

### PLASTIC BINS<sup>2</sup>

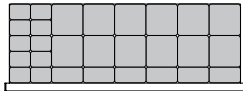

R\_HC-E028\_\_  
28 BINS

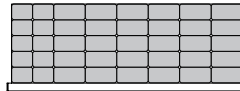

R\_HC-E040\_\_  
40 BINS

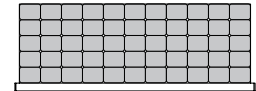

R\_HC-E055\_\_  
55 BINS

### FOAM<sup>2</sup>



R\_HC-J01\_\_  
PROTECTIVE FOAM

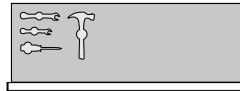

R\_HC-J02\_\_  
TOOL FOAM



### GROOVE TRAYS<sup>1,2</sup>

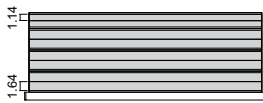

R\_HC-TD08\_\_  
8 GROOVE TRAYS

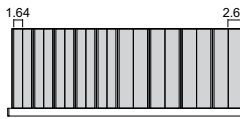

R\_HC-TW18\_\_  
18 GROOVE TRAYS

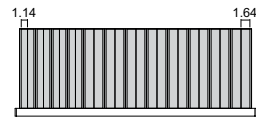

R\_HC-TW24\_\_  
24 GROOVE TRAYS

### HANGING FILE BARS<sup>3</sup>



R\_HC-KLR\_\_  
WIDTH

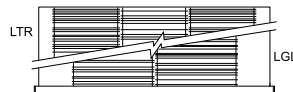

R\_HC-KFB\_\_  
DEPTH



NOTES: <sup>1</sup> Two dividers included with each groove. <sup>2</sup> Available for 3"H and 4"H drawers. <sup>3</sup> Available for 12"H and 14"H drawers.

# PRECONFIGURED MODELS

## 48"W x 24"D DRAWERS – CABINETS / MULTI-DRAWER / SHELVING

### PARTITIONS AND DIVIDERS

<p>R_<u>HE</u>-A0304__ 8 COMPARTMENTS</p>	<p>R_<u>HE</u>-A0308__ 12 COMPARTMENTS</p>	<p>R_<u>HE</u>-A0410__ 15 COMPARTMENTS</p>	<p>R_<u>HE</u>-A0415__ 20 COMPARTMENTS</p>
<p>R_<u>HE</u>-A0420__ 25 COMPARTMENTS</p>	<p>R_<u>HE</u>-C0505__ 11 COMPARTMENTS</p>	<p>R_<u>HE</u>-A0512__ 18 COMPARTMENTS</p>	<p>R_<u>HE</u>-A0518__ 24 COMPARTMENTS</p>
<p>R_<u>HE</u>-A0614__ 21 COMPARTMENTS</p>	<p>R_<u>HE</u>-D0618__ 25 COMPARTMENTS</p>	<p>R_<u>HE</u>-A0621__ 28 COMPARTMENTS</p>	<p>R_<u>HE</u>-A0628__ 35 COMPARTMENTS</p>
<p>R_<u>HE</u>-A0724__ 32 COMPARTMENTS</p>	<p>R_<u>HE</u>-A0732__ 40 COMPARTMENTS</p>	<p>R_<u>HE</u>-A0836__ 45 COMPARTMENTS</p>	<p>R_<u>HE</u>-A1044__ 55 COMPARTMENTS</p>

### PLASTIC BINS<sup>2</sup>

<p>R_<u>HE</u>-E038__ 38 BINS</p>	<p>R_<u>HE</u>-E056__ 56 BINS</p>	<p>R_<u>HE</u>-E077__ 77 BINS</p>
---------------------------------------	---------------------------------------	---------------------------------------

### HANGING FILE BARS<sup>3</sup>

R\_HE-KLR\_\_  
WIDTH

### GROOVE TRAYS<sup>1,2</sup>

<p>R_<u>HE</u>-TD10__ 10 GROOVE TRAYS</p>	<p>R_<u>HE</u>-TW18__ 18 GROOVE TRAYS</p>	<p>R_<u>HE</u>-TW24__ 24 GROOVE TRAYS</p>
---	---	---

R\_HE-KFB\_\_  
DEPTH

### FOAM<sup>2</sup>

<p>R_<u>HE</u>-J01__ PROTECTIVE FOAM</p>	<p>R_<u>HE</u>-J02__ TOOL FOAM</p>	<p>R_<u>HE</u>-J03__ COLLET FOAM</p>
--	--	--

Sold without cut-outs

NOTES: <sup>1</sup>Two dividers included with each groove. <sup>2</sup> Available for 3"H and 4"H drawers. <sup>3</sup> Available for 12"H and 14"H drawers.

## 48"W x 27"D DRAWERS – CABINETS / MULTI-DRAWER

### PARTITIONS AND DIVIDERS

<p>R_HG-A0304__ 8 COMPARTMENTS</p>	<p>R_HG-A0308__ 12 COMPARTMENTS</p>	<p>R_HG-A0312__ 16 COMPARTMENTS</p>	<p>R_HG-A0410__ 15 COMPARTMENTS</p>
<p>R_HG-A0415__ 20 COMPARTMENTS</p>	<p>R_HG-A0518__ 24 COMPARTMENTS</p>	<p>R_HG-A0524__ 30 COMPARTMENTS</p>	<p>R_HG-A0607__ 14 COMPARTMENTS</p>
<p>R_HG-A0621__ 28 COMPARTMENTS</p>	<p>R_HG-A0716__ 24 COMPARTMENTS</p>	<p>R_HG-A0724__ 32 COMPARTMENTS</p>	<p>R_HG-A0818__ 27 COMPARTMENTS</p>
<p>R_HG-A0836__ 45 COMPARTMENTS</p>	<p>R_HG-A1033__ 44 COMPARTMENTS</p>	<p>R_HG-D0615__ 22 COMPARTMENTS</p>	

### PLASTIC BINS<sup>2</sup>

<p>R_HG-E040__ 40 BINS</p>	<p>R_HG-E064__ 64 BINS</p>	<p>R_HG-E088__ 88 BINS</p>
--------------------------------	--------------------------------	--------------------------------

### HANGING FILE BARS<sup>3</sup>

<p>R_HG-KLR__ WIDTH</p>
-----------------------------

### GROOVE TRAYS<sup>1,2</sup>

<p>R_HG-TD12__ 12 GROOVE TRAYS</p>	<p>R_HG-TW18__ 18 GROOVE TRAYS</p>	<p>R_HG-TW24__ 24 GROOVE TRAYS</p>
--	--	--

<p>R_HG-KFB__ DEPTH</p>
-----------------------------

### FOAM<sup>2</sup>

<p>R_HG-J01__ PROTECTIVE FOAM</p>	<p>R_HG-J02__ TOOL FOAM</p>	<p>Sold without cut-outs</p>
---------------------------------------	---------------------------------	------------------------------

NOTES: <sup>1</sup> Two dividers included with each groove. <sup>2</sup> Available for 3"H and 4"H drawers. <sup>3</sup> Available for 12"H and 14"H drawers.

# PRECONFIGURED MODELS

## 54"W x 24"D DRAWERS – CABINETS / MULTI-DRAWER

### PARTITIONS AND DIVIDERS

<p>R_JE-B0200__ 3 COMPARTMENTS</p>	<p>R_JE-A0304__ 8 COMPARTMENTS</p>	<p>R_JE-A0405__ 10 COMPARTMENTS</p>	<p>R_JE-A0410__ 15 COMPARTMENTS</p>
<p>R_JE-A0512__ 18 COMPARTMENTS</p>	<p>R_JE-A0716__ 24 COMPARTMENTS</p>	<p>R_JE-A0708__ 16 COMPARTMENTS</p>	<p>R_JE-A0930__ 40 COMPARTMENTS</p>
<p>R_JE-A1124__ 36 COMPARTMENTS</p>	<p>R_JE-A1596__ 112 COMPARTMENTS</p>	<p>R_JE-C0202__ 5 COMPARTMENTS</p>	<p>R_JE-D0824__ 33 COMPARTMENTS</p>

### PLASTIC BINS<sup>2</sup>

<p>R_JE-E042__ 42 BINS</p>	<p>R_JE-E063__ 63 BINS</p>	<p>R_JE-E084__ 84 BINS</p>
--------------------------------	--------------------------------	--------------------------------

### FOAM<sup>2</sup>

<p>R_JE-J01__ PROTECTIVE FOAM</p>	<p>R_JE-J02__ TOOL FOAM</p>	<p>Sold without cut-outs</p>
---------------------------------------	---------------------------------	------------------------------

### GROOVE TRAYS<sup>1,2</sup>

<p>R_JE-TD10__ 10 GROOVE TRAYS</p>	<p>R_JE-TW20__ 20 GROOVE TRAYS</p>	<p>R_JE-TW22__ 22 GROOVE TRAYS</p>
--	--	--

### HANGING FILE BARS<sup>3</sup>

<p>R_JE-KFB__ DEPTH</p>
-----------------------------

NOTES: <sup>1</sup> Two dividers included with each groove. <sup>2</sup> Available for 3"H and 4"H drawers. <sup>3</sup> Available for 12"H and 14"H drawers.



## 54"W x 27"D DRAWERS – CABINETS / MULTI-DRAWER

### PARTITIONS AND DIVIDERS

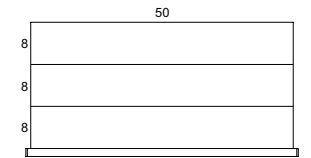

R\_JG-B0200\_\_  
3 COMPARTMENTS

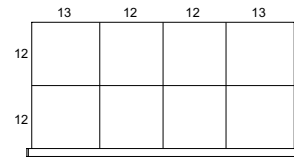

R\_JG-A0304\_\_  
8 COMPARTMENTS

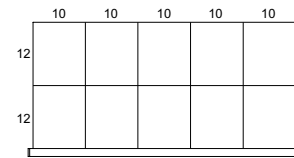

R\_JG-A0405\_\_  
10 COMPARTMENTS

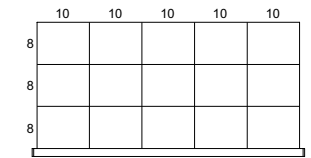

R\_JG-A0410\_\_  
15 COMPARTMENTS

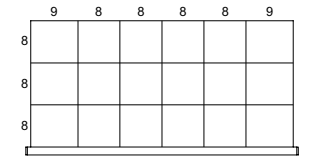

R\_JG-A0512\_\_  
18 COMPARTMENTS

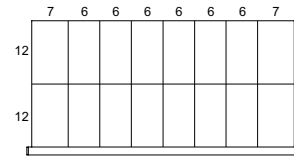

R\_JG-A0708\_\_  
16 COMPARTMENTS

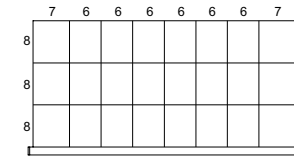

R\_JG-A0716\_\_  
24 COMPARTMENTS

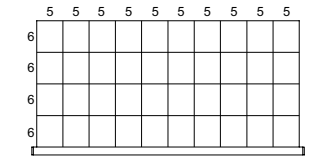

R\_JG-A0930\_\_  
40 COMPARTMENTS

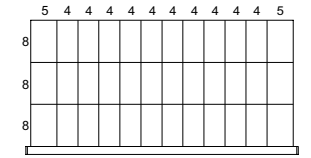

R\_JG-A1124\_\_  
36 COMPARTMENTS

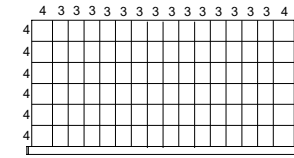

R\_JG-A1580\_\_  
96 COMPARTMENTS

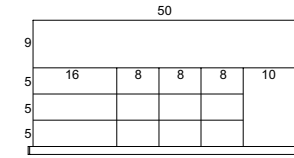

R\_JG-C0508\_\_  
14 COMPARTMENTS

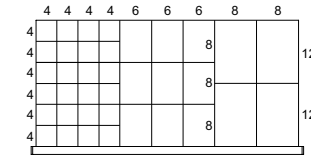

R\_JG-D0828\_\_  
37 COMPARTMENTS

### PLASTIC BINS<sup>2</sup>

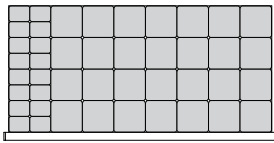

R\_JG-E044\_\_  
44 BINS

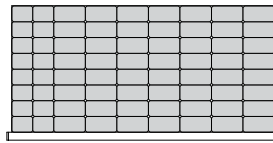

R\_JG-E072\_\_  
72 BINS

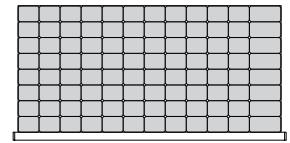

R\_JG-E096\_\_  
96 BINS

### FOAM<sup>2</sup>



R\_JG-J01\_\_  
PROTECTIVE FOAM

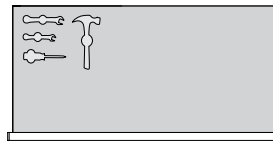

R\_JG-J02\_\_  
TOOL FOAM



### GROOVE TRAYS<sup>1,2</sup>



R\_JG-TD12\_\_  
12 GROOVE TRAYS



R\_JG-TW20\_\_  
20 GROOVE TRAYS

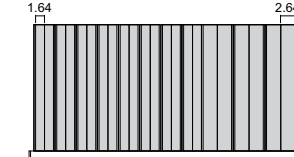

R\_JG-TW22\_\_  
22 GROOVE TRAYS

### HANGING FILE BARS<sup>3</sup>

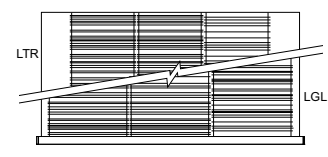

R\_JG-KFB\_\_  
DEPTH

NOTES: <sup>1</sup> Two dividers included with each groove. <sup>2</sup> Available for 3"H and 4"H drawers. <sup>3</sup> Available for 12"H and 14"H drawers.

# PRECONFIGURED MODELS

## 60"W x 24"D DRAWERS – CABINETS / MULTI-DRAWER

### PARTITIONS AND DIVIDERS

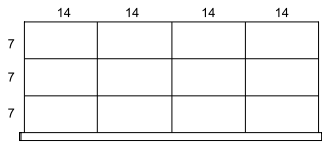

R\_\_KE-A0308\_\_  
12 COMPARTMENTS

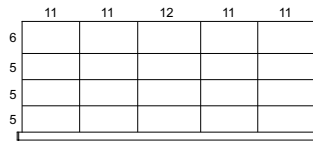

R\_\_KE-A0415\_\_  
20 COMPARTMENTS

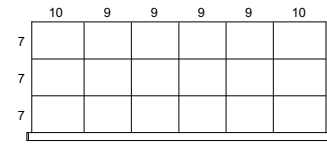

R\_\_KE-A0512\_\_  
18 COMPARTMENTS

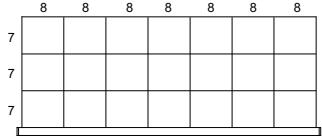

R\_\_KE-A0614\_\_  
21 COMPARTMENTS

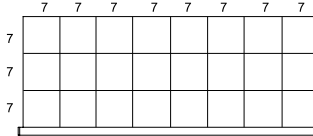

R\_\_KE-A0716\_\_  
24 COMPARTMENTS

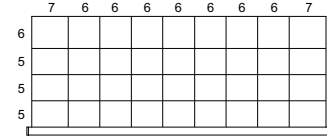

R\_\_KE-A0827\_\_  
36 COMPARTMENTS

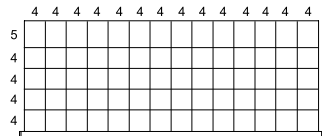

R\_\_KE-A1356\_\_  
70 COMPARTMENTS

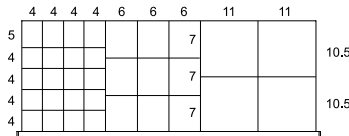

R\_\_KE-D0824\_\_  
33 COMPARTMENTS

### HANGING FILE BARS<sup>3</sup>

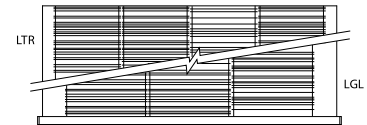

R\_\_KE-KFB\_\_  
DEPTH

### PLASTIC BINS<sup>2</sup>

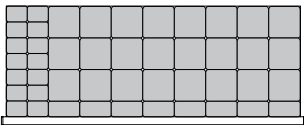

R\_\_KE-E046\_\_  
46 BINS

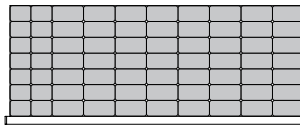

R\_\_KE-E070\_\_  
70 BINS

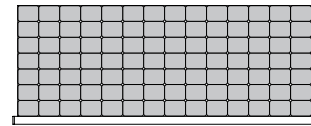

R\_\_KE-E098\_\_  
98 BINS

### FOAM<sup>2</sup>



R\_\_KE-J01\_\_  
PROTECTIVE FOAM



R\_\_KE-J02\_\_  
TOOL FOAM



### GROOVE TRAYS<sup>1,2</sup>



R\_\_KE-TD10\_\_  
10 GROOVE TRAYS

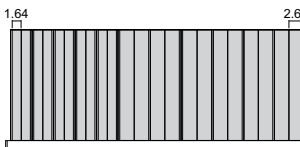

R\_\_KE-TW22\_\_  
22 GROOVE TRAYS

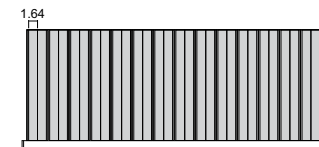

R\_\_KE-TW28\_\_  
28 GROOVE TRAYS

NOTES: <sup>1</sup> Two dividers included with each groove. <sup>2</sup> Available for 3"H and 4"H drawers. <sup>3</sup> Available for 12"H and 14"H drawers.

## 60"W x 27"D DRAWERS – CABINETS / MULTI-DRAWER

### PARTITIONS AND DIVIDERS

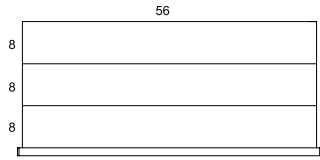

R\_\_KG-B0200\_\_

3 COMPARTMENTS

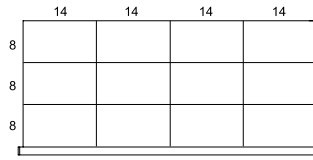

R\_\_KG-A0308\_\_

12 COMPARTMENTS

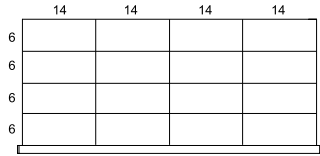

R\_\_KG-A0312\_\_

16 COMPARTMENTS

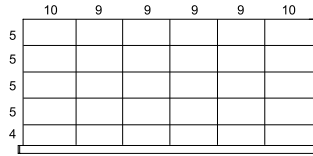

R\_\_KG-A0524\_\_

30 COMPARTMENTS

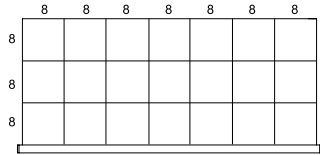

R\_\_KG-A0614\_\_

21 COMPARTMENTS

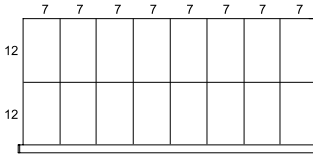

R\_\_KG-A0708\_\_

16 COMPARTMENTS

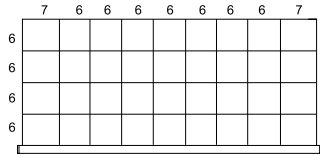

R\_\_KG-A0827\_\_

36 COMPARTMENTS

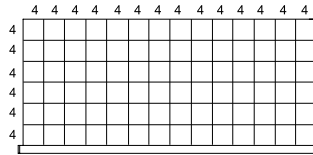

R\_\_KG-A1370\_\_

84 COMPARTMENTS

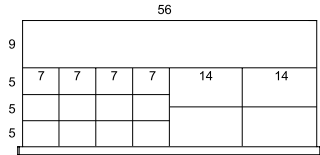

R\_\_KG-C0610\_\_

17 COMPARTMENTS

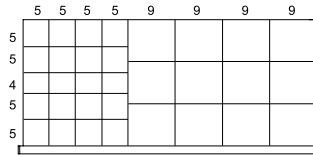

R\_\_KG-D0724\_\_

32 COMPARTMENTS

### PLASTIC BINS<sup>2</sup>

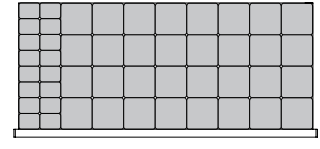

R\_\_KG-E048\_\_

48 BINS

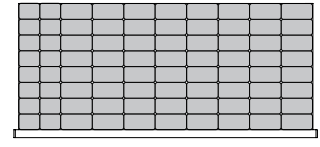

R\_\_KG-E080\_\_

80 BINS

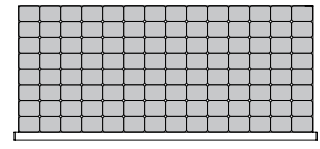

R\_\_KG-E112\_\_

112 BINS

### HANGING FILE BARS<sup>3</sup>

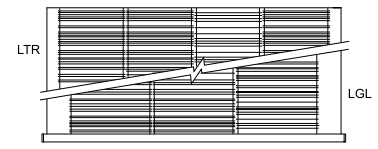

R\_\_KG-KFB\_\_

DEPTH

### FOAM<sup>2</sup>



R\_\_KG-J01\_\_

PROTECTIVE FOAM

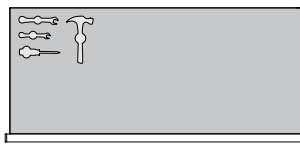

R\_\_KG-J02\_\_

TOOL FOAM



Sold without cut-outs

### GROOVE TRAYS<sup>1,2</sup>

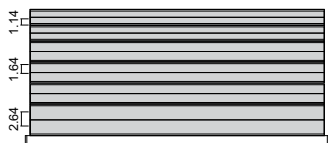

R\_\_KG-TD12\_\_

12 GROOVE TRAYS

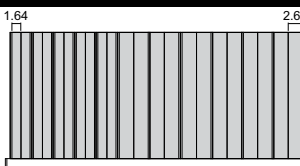

R\_\_KG-TW22\_\_

22 GROOVE TRAYS

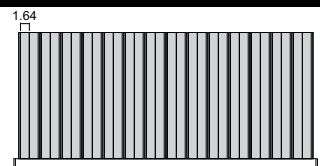

R\_\_KG-TW28\_\_

28 GROOVE TRAYS

NOTES: <sup>1</sup> Two dividers included with each groove. <sup>2</sup> Available for 3"H and 4"H drawers. <sup>3</sup> Available for 12"H and 14"H drawers.

## SUBDIVIDING ACCESSORIES



Our tool-free "clip-in" subdividing system keeps the dividers firmly in place and reduces noise caused by vibrations.

### FRONT TO BACK PARTITION

RG00



- Divides the drawer along its depth
- Clip-in system locks dividers in place
- Adjustable in 1" increments (c/c)
- Color: Light Gray (#071)
- Compatible with the following accessories: plastic bins (RG20/RG21), groove trays (RG35), hanging file bars (RG30/RG31) and PVC drawer liners (RG40)

NOMINAL CABINET DEPTH (ACTUAL)	DRAWER FACE HEIGHT (ACTUAL PARTITION HEIGHT)						
	3" (1 1/4"H)	4" (2 3/4"H)	5" (3 3/4"H)	6" AND 7" (4 3/4"H)	8" AND 9" (6 3/4"H)	10" (8 3/4"H)	12" AND 14" (10 3/4"H)
18" (15")	RG00-1803	RG00-1804	RG00-1805	RG00-1806	RG00-1808	RG00-1810	RG00-1812
21" (18")	RG00-2103	RG00-2104	RG00-2105	RG00-2106	RG00-2108	RG00-2110	RG00-2112
24" (21")	RG00-2403	RG00-2404	RG00-2405	RG00-2406	RG00-2408	RG00-2410	RG00-2412
27" (24")	RG00-2703	RG00-2704	RG00-2705	RG00-2706	RG00-2708	RG00-2710	RG00-2712

### LEFT TO RIGHT PARTITION

RG01



- Divides the drawer across its width
- Clip-in system locks dividers in place
- Adjustable in 1/2" increments (c/c)
- Color: Light Gray (#071)
- Compatible with the following accessories: plastic bins (RG20/RG21), groove trays (RG35), hanging file bars (RG30/RG31) and PVC drawer liners (RG40)

NOMINAL DRAWER WIDTH (ACTUAL)	DRAWER FACE HEIGHT (ACTUAL PARTITION HEIGHT)						
	3" (1 1/4"H)	4" (2 3/4"H)	5" (3 3/4"H)	6" AND 7" (4 3/4"H)	8" AND 9" (6 3/4"H)	10" (8 3/4"H)	12" AND 14" (10 3/4"H)
18" (14")	RG01-1803	RG01-1804	RG01-1805	RG01-1806	RG01-1808	RG01-1810	RG01-1812
24" (20")	RG01-2403	RG01-2404	RG01-2405	RG01-2406	RG01-2408	RG01-2410	RG01-2412
30" (26")	RG01-3003	RG01-3004	RG01-3005	RG01-3006	RG01-3008	RG01-3010	RG01-3012
36" (32")	RG01-3603	RG01-3604	RG01-3605	RG01-3606	RG01-3608	RG01-3610	RG01-3612
42" (38")	RG01-4203	RG01-4204	RG01-4205	RG01-4206	RG01-4208	RG01-4210	RG01-4212
48" (44")	RG01-4803	RG01-4804	RG01-4805	RG01-4806	RG01-4808	RG01-4810	RG01-4812
54" (50")	RG01-5403	RG01-5404	RG01-5405	RG01-5406	RG01-5408	RG01-5410	RG01-5412
60" (56")	RG01-6003	RG01-6004	RG01-6005	RG01-6006	RG01-6008	RG01-6010	RG01-6012

### DRAWER DIVIDER

RG10

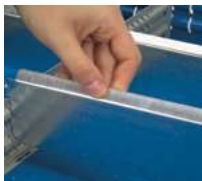

- Dividers clip in place
- 45° angled edge for easy identification of compartment contents
- Galvanized steel
- Adjustable in 1/2" increments (c/c)

ACTUAL DIVIDER WIDTH	DRAWER FACE HEIGHT (ACTUAL DIVIDER HEIGHT)						
	3" (1 1/4"H)	4" (2 3/4"H)	5" (3 3/4"H)	6" AND 7" (4 3/4"H)	8" AND 9" (6 3/4"H)	10" (8 3/4"H)	12" AND 14" (10 3/4"H)
3"	RG10-03003	RG10-03004	RG10-03005	RG10-03006	-	-	-
*3.5"	RG10-03503	RG10-03504	RG10-03505	RG10-03506	-	-	-
4"	RG10-04003	RG10-04004	RG10-04005	RG10-04006	-	-	-
5"	RG10-05003	RG10-05004	RG10-05005	RG10-05006	RG10-05008	RG10-05010	-
*5.5"	RG10-05503	RG10-05504	RG10-05505	RG10-05506	RG10-05508	RG10-05510	-
6"	RG10-06003	RG10-06004	RG10-06005	RG10-06006	RG10-06008	RG10-06010	RG10-06012
*6.5"	RG10-06503	RG10-06504	RG10-06505	RG10-06506	RG10-06508	RG10-06510	RG10-06512
7"	RG10-07003	RG10-07004	RG10-07005	RG10-07006	RG10-07008	RG10-07010	RG10-07012
8"	RG10-08003	RG10-08004	RG10-08005	RG10-08006	RG10-08008	RG10-08010	RG10-08012
9"	RG10-09003	RG10-09004	RG10-09005	RG10-09006	RG10-09008	RG10-09010	RG10-09012
*9.5"	RG10-09503	RG10-09504	RG10-09505	RG10-09506	RG10-09508	RG10-09510	RG10-09512
10"	RG10-10003	RG10-10004	RG10-10005	RG10-10006	RG10-10008	RG10-10010	RG10-10012
11"	RG10-11003	RG10-11004	RG10-11005	RG10-11006	RG10-11008	RG10-11010	RG10-11012
12"	RG10-12003	RG10-12004	RG10-12005	RG10-12006	RG10-12008	RG10-12010	RG10-12012
13"	RG10-13003	RG10-13004	RG10-13005	RG10-13006	RG10-13008	RG10-13010	RG10-13012
14"	RG10-14003	RG10-14004	RG10-14005	RG10-14006	RG10-14008	RG10-14010	RG10-14012
16"	RG10-16003	RG10-16004	RG10-16005	RG10-16006	RG10-16008	RG10-16010	RG10-16012

NOTE: \*These dimensions are not compatible with all drawer widths.

## LABEL HOLDERS AND HANDLE PROTECTOR

### 1" H LABEL HOLDER

RG51

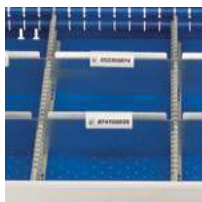

- Made of transparent, matte plastic that eliminates glare and makes labels easy to read
- Once clipped in place, the label holder is securely attached and does not come off when removing items
- Includes a flap to protect the label from damage
- Two standard widths available: 2" for all applications, and 2¾" for 3"W accessories and wider
- Can be attached to drawer partitions and dividers

PRODUCT NO.	W×H
RG51-200	2" × 1"
RG51-275	2¾" × 1"

NOTE: Cardboard labels are not included with label holders but are available in packs of 200.

### 1" H LABEL HOLDER WITH ADHESIVE STRIP FOR PLASTIC BINS

RG52



- Made of transparent, matte plastic that eliminates glare and makes labels easy to read
- Includes an adhesive strip for attaching to RG20 plastic bins. Also attaches to the back of the drawer for identification of the last compartment
- Includes a flap to protect the label from damage

PRODUCT NO.	W×H
RG52-200	2" × 1"

NOTE: Cardboard labels are not included with label holders but are available in packs of 200.

### CARDBOARD LABELS (PACKS OF 200)

RG53

PRODUCT NO.	W×H
RG53-275875	2¾" × ¾"

### 1 ¾" H LABEL HOLDER

RG54



- Made of transparent, matte plastic that eliminates glare and makes labels easy to read
- Once clipped in place, the label holder is securely attached and does not come off when removing items
- Includes a flap to protect the label from damage
- Two standard widths available: 2" and 4"
- Attaches to drawer dividers

PRODUCT NO.	W×H
RG54-200	2" × 1¾"
RG54-400	4" × 1¾"

NOTE: Cardboard labels are not included with label holders.

### 1 ¾" H LABEL HOLDER WITH ADHESIVE STRIP

RG55



- Made of transparent, matte plastic that eliminates glare and makes labels easy to read
- Includes an adhesive strip that attaches to the back of the drawer for identification of the last compartment
- Includes a flap to protect the label from damage
- Two standard widths available: 2" and 4"

PRODUCT NO.	W×H
RG55-200	2" × 1¾"
RG55-400	4" × 1¾"

NOTE: Cardboard labels are not included with label holders.

### HANDLE PROTECTOR

RF70



- Clips onto the handle of the drawer or roll-out shelf
- Made of transparent, matte plastic that eliminates glare and makes labels easy to read
- Protects identification labels from dust, grease and dirt
- Easy to remove

PRODUCT NO.	WIDTH
RF70-18	18"
RF70-24	24"
RF70-30	30"
RF70-36	36"
RF70-42	42"
RF70-48	48"
RF70-54	54"
RF70-60	60"

### HANDLE LABELS

RF71



- Labels to be attached to handles under the handle protector (RF70)
- 22 labels per page (10 pages)
- Print your own labels. A template is available on [www.rousseau-metal.com](http://www.rousseau-metal.com) under Information Center > Documents

PRODUCT NO.	W×H
RF71-425100	4½" × 1"

# ACCESSORIES

## DRAWER ACCESSORIES

### PVC DRAWER LINER

### RG40

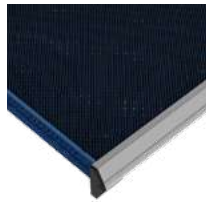

- Protects items stored in the drawer
- Non-slip material
- Can be installed under partitions and dividers
- Thickness: 3/32"

PRODUCT NO.	FOR DRAWER
RG40-1821-01	18"W x 21"D
RG40-1824-01	18"W x 24"D
RG40-1827-01	18"W x 27"D
RG40-2421-01	24"W x 21"D
RG40-2424-01	24"W x 24"D
RG40-2427-01	24"W x 27"D
RG40-3018-01	30"W x 18"D
RG40-3021-01	30"W x 21"D
RG40-3024-01	30"W x 24"D
RG40-3027-01	30"W x 27"D
RG40-3618-01	36"W x 18"D
RG40-3624-01	36"W x 24"D
RG40-3627-01	36"W x 27"D

NOTE: Do not use with ESD cabinets

### PROTECTIVE FOAM

### RG41

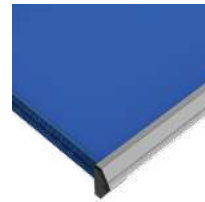

- Protects items stored in the drawer
- One piece of 1/4"-thick blue foam

PRODUCT NO.	FOR DRAWER
RG41-1821-01	18"W x 21"D
RG41-1824-01	18"W x 24"D
RG41-1827-01	18"W x 27"D
RG41-2421-01	24"W x 21"D
RG41-2424-01	24"W x 24"D
RG41-2427-01	24"W x 27"D
RG41-3018-01	30"W x 18"D
RG41-3021-01	30"W x 21"D
RG41-3024-01	30"W x 24"D
RG41-3027-01	30"W x 27"D
RG41-3618-01	36"W x 18"D
RG41-3624-01	36"W x 24"D
RG41-3627-01	36"W x 27"D

NOTE: Partitions and dividers cannot be installed in the same drawer as this foam.

### TOOL FOAM

### RG42

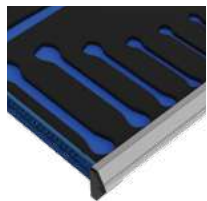

- Oil resistant and non-absorbent
- One piece of 1/4"-thick blue foam
- One piece of 1/2"-thick self-adhesive black foam
- Sold without cut-outs. Can be cut with a utility knife

PRODUCT NO.	FOR DRAWER
RG42-1821-01	18"W x 21"D
RG42-1824-01	18"W x 24"D
RG42-1827-01	18"W x 27"D
RG42-2421-01	24"W x 21"D
RG42-2424-01	24"W x 24"D
RG42-2427-01	24"W x 27"D
RG42-3018-01	30"W x 18"D
RG42-3021-01	30"W x 21"D
RG42-3024-01	30"W x 24"D
RG42-3027-01	30"W x 27"D
RG42-3618-01	36"W x 18"D
RG42-3624-01	36"W x 24"D
RG42-3627-01	36"W x 27"D

PRODUCT NO.	FOR DRAWER
RG42-4218-01	42"W x 18"D
RG42-4224-01	42"W x 24"D
RG42-4818-01	48"W x 18"D
RG42-4824-01	48"W x 24"D
RG42-4827-01	48"W x 27"D
RG42-5424-01	54"W x 24"D
RG42-5427-01	54"W x 27"D
RG42-6024-01	60"W x 24"D
RG42-6027-01	60"W x 27"D



### COLLET FOAM

### RG43

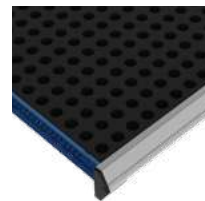

- Oil resistant and non-absorbent
- One piece of 1"-thick black foam
- Sold without cut-outs. Can be cut with a hole punch

PRODUCT NO.	FOR DRAWER
RG43-1821-01	18"W x 21"D
RG43-1824-01	18"W x 24"D
RG43-1827-01	18"W x 27"D
RG43-2421-01	24"W x 21"D
RG43-2424-01	24"W x 24"D
RG43-2427-01	24"W x 27"D
RG43-3018-01	30"W x 18"D
RG43-3021-01	30"W x 21"D
RG43-3024-01	30"W x 24"D
RG43-3027-01	30"W x 27"D
RG43-3618-01	36"W x 18"D
RG43-3624-01	36"W x 24"D

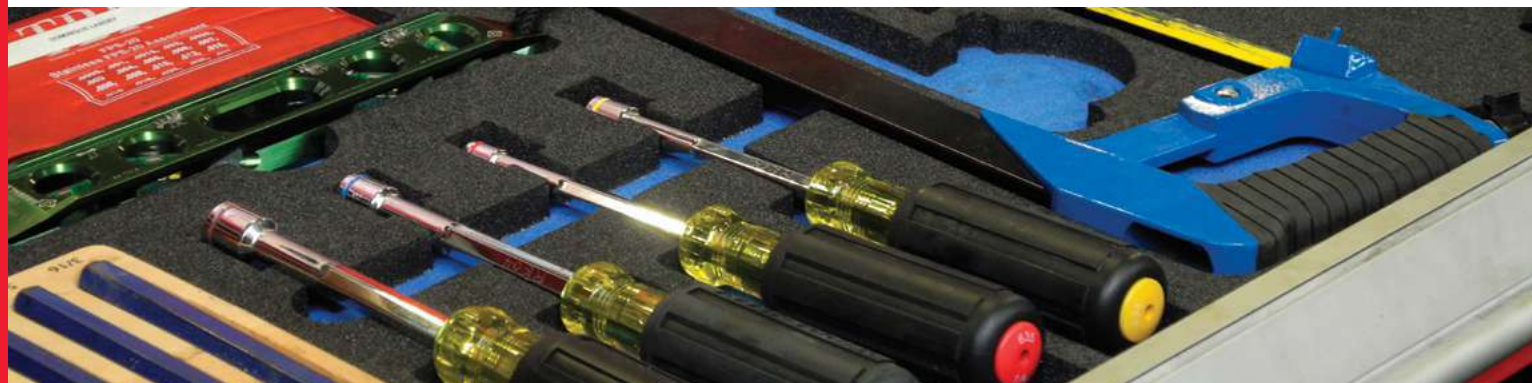



RG20

## PLASTIC BIN

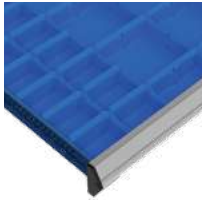

- For easier storing, moving and managing of small parts Lightweight and durable
- For 3"H and 4"H drawers
- 45° angled rim for easy identification of bin contents and removal of bins



- Compatible with the following accessories: partitions, dividers and groove trays
- 6" plastic bins can be subdivided

DIMENSIONS			PRODUCT NO.		
W	D	H	BIN	PARTITION	DIVIDER
3"	3"	2"	RG20-030302	-	-
4"	3"	2"	RG20-040302	-	-
6"	3"	2"	RG20-060302	RG22-0302	-
6"	6"	2"	RG20-060602	RG22-0602	RG24-0602
3"	3"	3"	RG20-030303	-	-
4"	3"	3"	RG20-040303	-	-
6"	3"	3"	RG20-060303	RG22-0303	-
6"	6"	3"	RG20-060603	RG22-0603	RG24-0603

NOTE: 2"H bins = 1½" actual height  
3"H bins = 2½" actual height



RG21

## CONDUCTIVE PLASTIC BIN



- Dissipates electrical charges that can damage electronic components
- For easier storing, moving and managing of small parts
- Lightweight and durable
- For 3"H and 4"H drawers



- 45° angled rim for easy identification of bin contents and removal of bins
- Color: black
- 6" plastic bins can be subdivided

DIMENSIONS			PRODUCT NO.		
W	D	H	BIN	PARTITION	DIVIDER
3"	3"	2"	RG21-030302	-	-
4"	3"	2"	RG21-040302	-	-
6"	3"	2"	RG21-060302	RG23-0302	-
6"	6"	2"	RG21-060602	RG23-0602	RG25-0602
3"	3"	3"	RG21-030303	-	-
4"	3"	3"	RG21-040303	-	-
6"	3"	3"	RG21-060303	RG23-0303	-
6"	6"	3"	RG21-060603	RG23-0603	RG25-0603

NOTE: 2"H bins = 1½" actual height  
3"H bins = 2½" actual height

## GROOVE TRAYS

RG35 / RG36

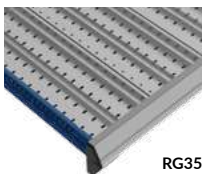

RG35



RG36

- For storing and protecting long objects such as drill bits, borers, sockets, lathe parts, files, tools, etc.
- Made of durable aluminum
- Vertical partitions for more storage space
- Wide compartment bottoms for easy cleaning
- Gray plastic divider with ¾" angled labeling area (to be ordered separately)
- For 3"H and 4"H drawers
- Compatible with the following accessories: partitions, dividers and plastic bins
- To order: Complete the product number with the depth required: 18", 21", 24", 27", or the width required 18", 24", 30", 36", 42", 48", 54", 60"

PRODUCT NO.		DIVIDER NO.
FRONT TO BACK	LEFT TO RIGHT	
RG35-03DD	RG36-03WW	RG39-03
RG35-04DD	RG36-04WW	RG39-04
RG35-06DD	RG36-06WW	RG39-06



RG39

NOTE: For drawer interior measurements, see pages 220-222

## HANGING FILE BARS

RG30 / RG31

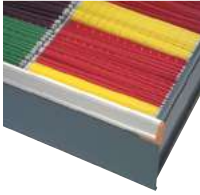

- For storing hanging files
- Fits both letter and legal sizes depending on the drawer dimensions
- For 12"H and 14"H drawers
- Compatible with partitions and dividers, see page 242

FRONT TO BACK BARS		LEFT TO RIGHT BARS	
PRODUCT NO.	NOMINAL DEPTH (ACTUAL)	PRODUCT NO.	NOMINAL WIDTH (ACTUAL)
RG30-18	18" (15")	RG31-18	18" (14")
RG30-21	21" (18")	RG31-24	24" (20")
RG30-24	24" (21")	RG31-30	30" (26")
RG30-27	27" (24")	RG31-36	36" (32")
		RG31-42	42" (38")
		RG31-48	48" (44")

## WASTE & RECYCLING DRAWER



- Used for sorting waste and items for recycling
- Includes a labeled drawer handle to facilitate sorting
- Drawer heights available: 17" and 26"
- The 17"H drawer includes two 14 $\frac{3}{8}$ "W x 10 $\frac{1}{4}$ "D x 15"H containers: a black container for waste and a blue container for recycling
- The 26"H drawer includes two 15 $\frac{3}{4}$ "W x 11"D x 20"H containers: a black container for waste and a blue container for recycling
- The drawer includes a divider which secures the containers and also allows items to be stored behind
- To add a locking or security mechanism, complete the product number with the locking mechanism product number required, e.g., R51CG-X1701A to add an integrated lock-in mechanism

PRODUCT NO.	W x D x H
R51CG-X1701	24" x 27" x 17"
R51CG-X2601	24" x 27" x 26"
R51DG-X1701	30" x 27" x 17"
R51DG-X2601	30" x 27" x 26"



R5XLG-3004





## LOCKING AND SECURITY MECHANISMS

### INTEGRATED LOCK-IN MECHANISM

A



- Integrated lock-in mechanism
- Automatically activated when lifting the handle up
- The drawer or roll-out shelf can be opened with one hand only
- Closes with a simple push
- Stops drawer or roll-out shelf from opening on their own
- Easy to retrofit
- To order: Add A to the product number for the drawer, preconfigured compartment layout or roll-out shelf, e.g., RF32-362406A
- For replacement parts or to retrofit this mechanism, order an RY08-WWA

PRODUCT NO.

A

### ECONO LOCK-IN MECHANISM

B



- Activated with the right hand by sliding the mechanism with thumb
- The drawer or roll-out shelf closes without having to reactivate the slide mechanism
- Stops drawer or roll-out shelf from opening on their own
- To order: Add B to the product number for the drawer, preconfigured compartment layout or roll-out shelf, e.g., RF32-362406B
- For replacement parts or to retrofit this mechanism, order an RY01-B

PRODUCT NO.

B

### LOCK-OUT MECHANISM

RF85

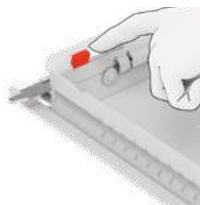

- For both drawers and roll-out shelves
- Locks drawers and roll-out shelves in an open position
- Activated manually, only when required
- Compatible with all drawer accessories
- Plastic bins in the back row may make it more difficult to activate the mechanism

PRODUCT NO.

RF85

### DRAWER LOCK

L3



- Compatible with all drawer dimensions
- Does not reduce the drawer's storage space
- Easy to retrofit
- To order: Add L3 to the product number for the drawer or preconfigured compartment layout, e.g., RF32-362406L3
- For replacement parts or to retrofit this mechanism, order an RY01-L3

PRODUCT NO.

L3





INDEX	PAGE(S)
Computer Station	248
Preconfigured Models . . .	249-253
Components . . . . .	254-259

## COMPUTER STATION

With our vast range of products and accessories, you can create a customized computer station tailored to your needs.

Whether you need a simple computer cabinet, look-up station or fully-equipped workstation with extra storage and accessories, we have the ideal solution.

Our products are designed for industrial use (production floor, packing, maintenance and repair, machine shops, etc.), but their attractive design also lends themselves to office environments (laboratories, electronics and IT environments, etc.).

## COMPUTER CABINET

Rousseau computer cabinets provide protection for computer equipment. The fan with filter help to remove heat from the unit.

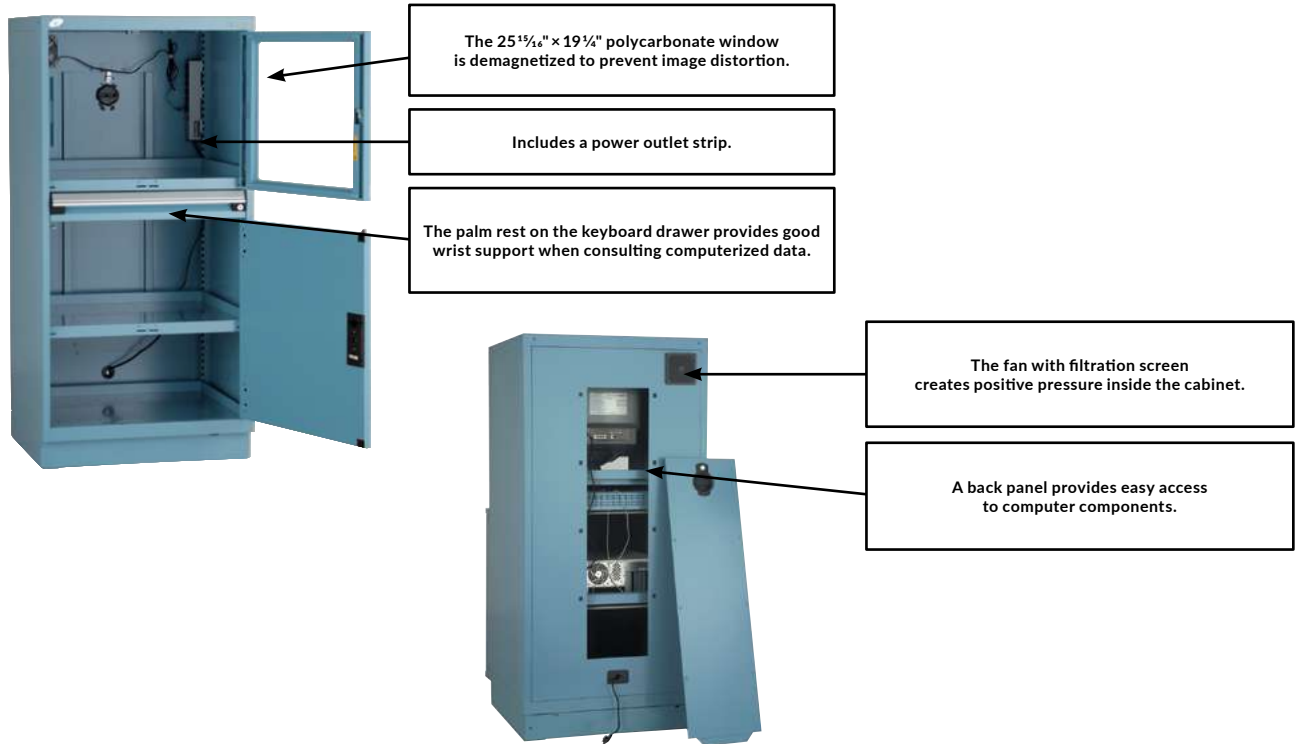

## COMPUTER CABINET WITH ADJUSTABLE SHELF

### Stationary



R5JDG-5801

- 1 computer cabinet housing with back access panel
- 1 adjustable shelf (for monitor)
- 1 keyboard drawer
- 1 keyboard riser
- 1 adjustable shelf (for printer)
- 1 bottom shelf (for computer)
- 1 polycarbonate door for monitor
- 1 single integrated door

#### Stationary cabinet includes:

- 1 recessed base (front access)
- 1 back kick plate

#### Mobile cabinet includes:

- 2 rigid casters, 4"
- 2 swivel casters with total-lock brake, 4"

MODEL	PRODUCT NO.	W x D x H
Stationary	R5JDG-5801	30" x 27" x 62"
Mobile	R5JDG-5821	30" x 27" x 63 <sup>1</sup> / <sub>4</sub> "

### Mobile



R5JDG-5821



# PRECONFIGURED MODELS

## COMPUTER CABINET WITH ROLL-OUT SHELF

### Stationary



R5JDG-5815

- 1 computer cabinet housing with back access panel
- 1 adjustable shelf (for monitor)
- 1 keyboard drawer
- 1 keyboard riser
- 1 front access roll-out shelf (for printer)
- 1 bottom shelf (for computer)
- 1 polycarbonate door for monitor
- 1 single integrated door

#### Stationary cabinet includes:

- 1 recessed base (front access)
- 1 back kick plate

#### Mobile cabinet includes:

- 2 rigid casters, 4"
- 2 swivel casters with total-lock brake, 4"

MODEL	PRODUCT NO.	W×D×H
Stationary	R5JDG-5815	30"×27"×62"
Mobile	R5JDG-5837	30"×27"×63¼"

### Mobile



R5JDG-5837



## COMPUTER CABINET WITH TWO ROLL-OUT SHELVES

### Stationary



R5JDG-5819

- 1 computer cabinet housing with back access panel
- 1 adjustable shelf (for monitor)
- 1 keyboard drawer
- 1 keyboard riser
- 1 front access roll-out shelf (for printer)
- 1 front access roll-out shelf (for computer)
- 1 polycarbonate door for monitor
- 1 single integrated door

#### Stationary cabinet includes:

- 1 recessed base (front access)
- 1 back kick plate

#### Mobile cabinet includes:

- 2 rigid casters, 4"
- 2 swivel casters with total-lock brake, 4"

MODEL	PRODUCT NO.	W×D×H
Stationary	R5JDG-5819	30"×27"×62"
Mobile	R5JDG-5839	30"×27"×63¼"

### Mobile



R5JDG-5839



## WALL-MOUNTED COMPUTER CABINET

Our wall-mounted computer cabinet is an interesting alternative to conventional computer cabinets. You can choose from various door and keyboard tray configurations to meet your specific requirements.

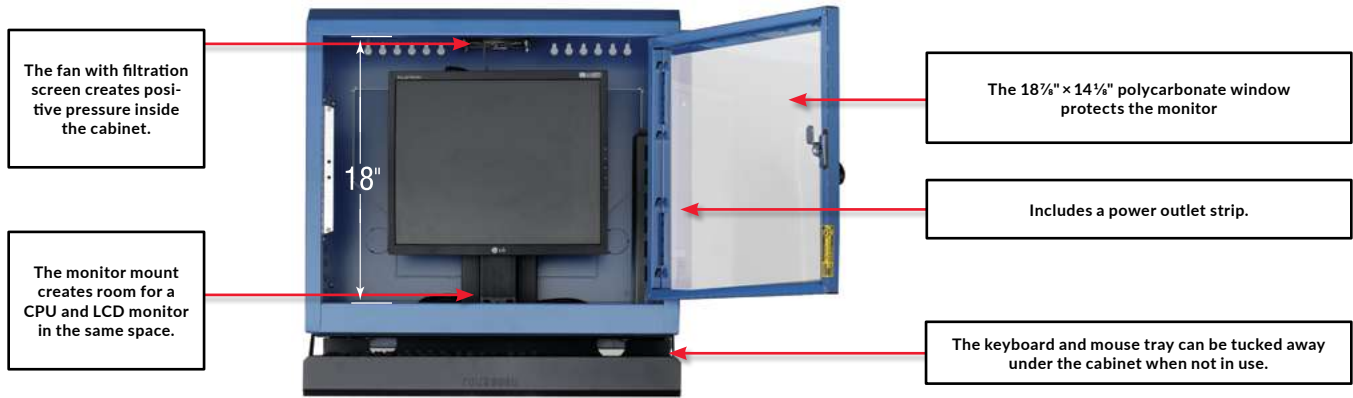

## WALL-MOUNTED COMPUTER CABINET WITH CHOICE OF CONFIGURATIONS

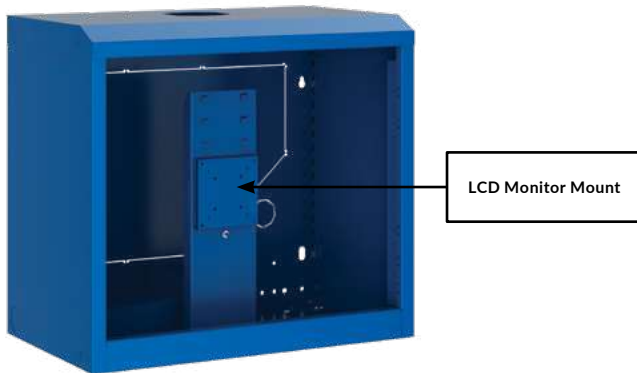

- Cabinet dimensions: 24"W × 14"D × 21"H
- Polycarbonate window dimensions: 18<sup>7</sup>/<sub>8</sub>"W × 14<sup>1</sup>/<sub>8</sub>"H
- Keyboard tray's usable area: 22<sup>1</sup>/<sub>2</sub>"W × 14<sup>1</sup>/<sub>2</sub>"D

PRODUCT NO.	TYPE
R5MCA-2450	Wall-mounted cabinet only
R5MCA-2451	Wall-mounted cabinet with polycarbonate door
R5MCA-2452	Wall-mounted cabinet with keyboard and mouse tray
R5MCA-2453	Wall-mounted cabinet with polycarbonate door, and keyboard and mouse tray
R5MCA-2454	Wall-mounted cabinet with flipper door and laptop tray

NOTES: Wall-mounted cabinets include an LCD monitor mount.  
Model R5MCA-2454 is sold without the fan and power outlet strip.

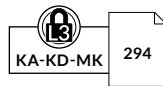

NOTE: A RD47 tray can also be installed under an RD02 cabinet to hold a laptop.

# PRECONFIGURED MODELS

## WORKSTATION

Some of our most popular computer workstations are shown below. Please refer to the Workcenters – WS/WM section for the various accessories and configurations available, [see pages 164-171](#).

### COMPUTER WORKSTATION WITH CPU HOLDER



LC3006C

PRODUCT NO.	W×D×H
LC3006C	60"×30"×58"

- 1 CPU holder
- 1 laminated hardwood top
- 1 open leg
- 1 L Compact Cabinet
- 3 multi-purpose uprights
- 2 upright crossmembers
- 1 adjustable keyboard tray
- 1 LCD monitor mount
- 1 power outlet module
- 1 tiltable shelf
- 2 plastic bin rails
- 8 plastic bins
- 2 partial dividers

### COMPUTER WORKSTATION WITH MONITOR AND KEYBOARD ARM



LC3005C

PRODUCT NO.	W×D×H
LC3005C	60"×30"×68"

- 1 double WM bench frame
- 1 LCD monitor and keyboard arm
- 1 tiltable shelf
- 3 partial dividers
- 1 plastic bin rail
- 4 plastic bins
- 1 power outlet module with three 12A outlets
- 1 tackboard / whiteboard
- 1 panel bracket kit
- 1 laminated hardwood top
- 1 open leg
- 1 L Compact Cabinet

### COMPUTER WORKSTATION WITH TABLET ARM



LC3123C

PRODUCT NO.	W×D×H
LC3123C	60"×30"×80"

- 1 double WM bench frame
- 1 tablet arm
- 2 tiltable shelves
- 4 partial dividers
- 2 plastic bin rails
- 6 plastic bins
- 1 power outlet channel with 3 power outlets (12A) and 2 USB ports
- 1 storage cabinet with door
- 1 overhead LED workstation light
- 1 pair of cantilever overhead supports
- 1 lamp with magnifier and LED light
- 1 plastic laminate top
- 1 open leg
- 1 L Compact Cabinet with 4"H base

## FREESTANDING STATIONS

Some popular freestanding station configurations are shown below. Please refer to the Freestanding Station section for the various accessories available, [see pages 164-171](#).

### OFF-CENTERED MODEL



WMA4061

PRODUCT NO.	W×D×H
WMA4061	32"×27"×85"

- 1 off-centered WM stand, 84"H
- 1 LCD monitor arm and keyboard & mouse tray
- 1 document holder with arm
- 1 tackboard / whiteboard
- 1 panel bracket kit
- 1 tiltable shelf
- 2 partial dividers
- 1 plastic bin rail
- 3 plastic bins
- 1 bottom shelf with ribbed mat

### CENTERED MODEL



WMA3051

PRODUCT NO.	W×D×H
WMA3051	32"×27"×85"

- 1 centered WM stand, 84"H
- 2 laptop trays
- 2 utility panels
- 1 panel bracket kit
- 1 document holder
- 2 plastic bin rails
- 6 plastic bins
- 2 tiltable shelves
- 1 pack of 10 double back single hooks
- 2 cantilever overhead supports
- 2 overhead LED workstation lights
- 1 bottom shelf with ribbed mat

# COMPONENTS

## COMPUTER CABINET

### COMPUTER CABINET HOUSING WITH BACK ACCESS PANEL

RD31



- Includes a fan with filtration screen
- Includes a power outlet strip
- Back panel provides easy access to computer components. Includes a lock
- Includes a grommet to run cables through

- Compatible with 4" and 6" casters
- Compatible with RA53 forklift bases, RA55 recessed bases and RB94/RB95 base risers

PRODUCT NO.	W×D×H
RD31-302758L3	30" × 27" × 58"



NOTE: Ordering a riser base (RA55, RB94 or RB95) is strongly recommended for using in a standing position or for taller people.

### RECESSED BASE

RA55



- Raises the height of a cabinet by 4"
- Can be used to move the cabinet from the front with a forklift or pallet truck
- Includes a removable kick plate at the front for a neater finish and for moving the cabinet from the front
- The front kick plate spans the full width for easier floor cleaning
- Compatible with an optional RA56 kick plate at the back (front kick plate is included)
- Compatible with RA74 leveling glides
- Designed so the cabinet can be anchored to the floor

PRODUCT NO.	W×D×H
RA55-302704	30" × 27" × 4"

NOTE: Not compatible with casters.

### RISER BASE

RB95



- Raises the height of a cabinet by 8"
- Provides improved ergonomics for taller people
- Installs directly under the cabinet
- Can be used for moving the cabinet from the front with a forklift
- Compatible with RA74 leveling glides
- Compatible with an optional RB98 kick plate at the back (front kick plate is included)

PRODUCT NO.	W×D×H
RB95-302708	30" × 27" × 8"

NOTE: Not compatible with casters.

### RISER BASE FOR MOBILE CABINET

RB94



- Raises the height of a mobile cabinet by 4"
- Provides improved ergonomics for taller people
- Installs directly under the cabinet
- Compatible with 4" and 6" casters

PRODUCT NO.	D×H
RB94-2704	27" × 4"

### KICK PLATE

RA56 / RB98

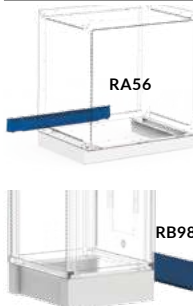

- RA56 Closes off the back of 4"H recessed bases (RA55)
- RB98 Closes off the back of riser bases (RB95)

PRODUCT NO.	W×H	FOR
RA56-3004	30" × 4"	RA55
RB98-3008	30" × 8"	RB95



## LEVELING GLIDE KIT

RA74



- Sold in kits of 4
- Adjusts the height of cabinets 1 1/8" to 2" on uneven floor surfaces
- Installs directly under a cabinet without base or under RB95 riser bases

PRODUCT NO.  
RA74-01

## ADJUSTABLE SHELF

RB21



- For storage of bulky items
- The back and side edges prevent objects from falling to the bottom of the cabinet
- Height can be adjusted in 1" increments c/c
- Load capacity of up to 400lb., evenly distributed

PRODUCT NO.      W x D  
RB21-3027            30" x 27"

## BOTTOM SHELF

RB25



- For storage of bulky items
- The back and side edges prevent objects from falling to the bottom of the cabinet
- Load capacity of up to 400lb., evenly distributed

PRODUCT NO.      W x D  
RB25-3027            30" x 27"

## CASTERS

RB81 / RB84



- Sold in pairs
- Three types of casters available: rigid, swivel and swivel with total-lock brake (on wheel and swivel)
- 4" caster: 5 1/4"H total
- 6" caster: 7 1/2"H total
- Heavy-duty, non-marking polyurethane casters; Superior industrial quality
- Casters are installed directly under a cabinet without base or under RB94 riser bases for mobile cabinets

PRODUCT NO.	HEIGHT	CASTER TYPE
RB81-01	4"	Rigid
RB81-02	4"	Swivel
RB81-03	4"	Swivel with total-lock brake
RB84-01	6"	Rigid
RB84-02	6"	Swivel
RB84-03	6"	Swivel with total-lock brake

## KEYBOARD RISER

RD40

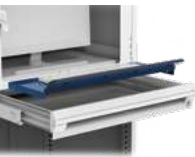

- Raises the keyboard and mouse into an ergonomic position
- Includes a palm rest
- Leaves room for a standard ring binder (12"D) to be stored behind the keyboard
- Leaves room for the drawer to be subdivided with partitions, dividers and plastic bins

PRODUCT NO.      W x D x H  
RD40-301204        30" x 12" x 4"

## KEYBOARD DRAWER

RF31



- A standard ring binder (12"D) can be stored behind the keyboard
- Can be subdivided with partitions, dividers and plastic bins [see pages 242-245](#)
- Standard lock included

PRODUCT NO.      W x D x H  
RF31-302704L3      30" x 27" x 4"

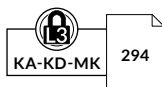

## ROLL-OUT SHELF FOR SINGLE INTEGRATED DOOR

RF55



- For storage of bulky items
- Compatible with RB62 integrated doors
- 65% extension
- Load capacity: 175lb.
- Painted steel with edges on the sides and back
- Full access to contents

PRODUCT NO.      W x D  
RF55-3027            30" x 27"

NOTE: To retrofit this product, order an RF56-3027.

NOTE: Ordering an RD40 keyboard riser is strongly recommended to place the keyboard and mouse in an ergonomic position.

# COMPONENTS

## FOLDAWAY SHELF

RC00



- Load capacity: 50lb. (evenly distributed)
- Includes a protective rubber surface
- Compatible with optional RCO1 side and back stops for foldaway shelf

PRODUCT NO.	W × D
RC00-152701	15" × 27"

## SIDE AND BACK STOPS FOR FOLDAWAY SHELF

RC01



- Use the 15" stop for front or back of shelf
- Use the 27" stop for the sides
- Height: 1"

PRODUCT NO.	WIDTH
RC01-15	15"
RC01-27	27"

## POLYCARBONATE DOOR FOR MONITOR

RD51



- The 24<sup>15</sup>/<sub>16</sub>"W × 19<sup>1</sup>/<sub>4</sub>"H polycarbonate window
- Factory installed on RD31 cabinet housings
- Standard lock included

PRODUCT NO.	W × H
RD51-3022L3	30" × 22"

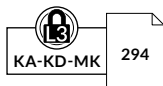

## SINGLE INTEGRATED DOOR, SOLID OR POLYCARBONATE

RB62 / RB61



- Integrated door: RB62
- Polycarbonate integrated door: RB61
- Compatible with RB25 bottom shelves, RB21 adjustable shelves and RF55 roll-out shelves
- Opens 180° for full access to items stored inside
- Factory installed on RD31 cabinet housings
- Add L3 to the product number for a standard lock, and L50 for an electronic lock

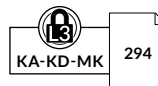

PRODUCT NO.	W × H
RB62-3028__	30" × 28"
RB61-3028__	30" × 28"

## ACCESSORIES UNDER THE WORK SURFACE

### SLIDING KEYBOARD TRAY

WS90



- Installs under all types of top
- Mouse tray slides to the left or right as required
- Usable surface area: 21 1/2"W × 11 3/16"D
- Mouse tray: 9 3/8"D × 9 3/8"W

PRODUCT NO.	COLOR
WS90-01	Black

### ADJUSTABLE KEYBOARD TRAY

WS90



- Mount with an articulating arm for working while sitting or standing
- Installs under all types of top
- Includes:
  - Mouse tray that slides to the left or right
  - Ergonomic palm wrist
- Usable surface area: 9 1/2"D × 20 1/2"W
- Mouse tray: 9 3/8"D × 9"W

PRODUCT NO.	COLOR
WS90-02	Black

### CPU HOLDER

WS92



- Installs under all types of top
- Includes a handle for adjusting the width of the plastic side support
- Adjustable to hold computer cases from 3 1/2"W to 9 1/4"W by 12 1/2"H to 22 1/2"H
- Width: 8 3/8" to 11 1/2"
- Depth: 6 3/4" (8 1/2" with handle)
- Height: 18" to 26"

PRODUCT NO.	COLOR
WS92-01	Black

COMPUTER MOUNTS FOR WORK SURFACES

All models featured here have the following characteristics:

- Installs on the work surface with an RC68 or RC69 cover panel for electronics mounts
- Compatible with the following work surfaces: RC35, RC37, WS08, WS14 and WS16
- Includes an 18"H pole for height adjustment to suit each user
- The work surface must extend beyond the rear by 1½"
- Articulating arms, adapters and trays are painted black
- Does not install directly on the housing
- Height can be easily adjusted, no tools required
- Optimum ergonomics

LCD MONITOR ARM



- Compatible with most LCD monitors (max. 21") on the market
- Complies with VESA 75 and 100 monitor mounting standards
- Includes one or two articulating arm(s) with two joints
- The articulating arm with two joints provides extra adjustment options
- Screen can be rotated and tilted
- Single and dual arm versions are available

PRODUCT NO.	FOR
RC59-03	Single Monitor
RC59-04	Two Monitors

LAPTOP ARM



- Holds a laptop, electronic device or any other object
- Tray's usable area: 14"W x 12"D
- Includes an articulating arm with two joints
- The articulating arm with two joints provides extra adjustment options
- Tray can be rotated and tilted

PRODUCT NO.
RC59-42

LCD MONITOR MOUNT AND KEYBOARD & MOUSE ARM



- Holds a computer monitor, keyboard and mouse
- Keyboard tray's usable area: 23¾"W x 8½"D
- Includes an articulating arm with a single joint
- Compatible with most LCD monitors (max. 21") on the market
- Complies with VESA 75 and 100 monitor mounting standards
- Screen and tray can be rotated and tilted

PRODUCT NO.
RC59-21

TABLET ARM



- Compatible with most tablets on the market
- The clamps and mount have a non-slip surface to keep the tablet stable
- Includes an articulating arm with two joints
- The articulating arm with two joints provides extra adjustment options
- Tablet can be rotated and tilted
- Compatible tablet sizes:
  - Small: 7¾"W to 10"W
  - Large: 9¾"W to 12¼"W

PRODUCT NO.	FOR
RC59-62-01	Small tablet
RC59-62-02	Large Tablet

# COMPONENTS

## COMPUTER MOUNTS FOR WM FRAMES AND WALL-MOUNTED APPLICATIONS

### IMPORTANT

All models featured below have the following characteristics:

- Color: black
- Superior durability
- Easy adjustment
- Anchoring hardware not included in the wall-mounted version



Wall-Mounted

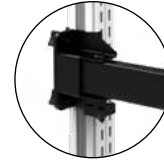

For WM11 Frame



Double Articulating Arm

### LAPTOP ARM



- Holds a laptop, electronic device or any other object
- Tray's usable area: 16"W x 13<sup>7</sup>/<sub>8</sub>"D
- Includes a heavy-duty articulating arm with one or two joints
- The heavy-duty articulating arm with two joints provides extra adjustment options
- The tray includes a non-slip rubber mat

JOINTS	FOR WM11 FRAME	WALL-MOUNTED
Single	WM62-01A	WM64-01A
Double	WM62-02A	WM64-02A

### LCD MONITOR ARM



- Compatible with most LCD monitors on the market
- Complies with VESA 75 and 100 monitor mounting standards
- Includes a heavy-duty articulating arm with one or two joints
- The heavy-duty articulating arm with two joints provides extra adjustment options
- Monitor can be rotated and tilted

JOINTS	FOR WM11 FRAME	WALL-MOUNTED
Single	WM65-01A	WM66-01A
Double	WM65-02A	WM66-02A

### LCD MONITOR ARM AND KEYBOARD & MOUSE TRAY



- Holds a computer monitor, keyboard and mouse
- Compatible with most LCD monitors on the market
- Complies with VESA 75 and 100 monitor mounting standards
- Keyboard tray's usable area: 23<sup>3</sup>/<sub>8</sub>"W x 8<sup>1</sup>/<sub>2</sub>"D
- Includes a heavy-duty articulating arm with one or two joints
- The heavy-duty articulating arm with two joints provides extra adjustment options
- Screen can be rotated and tilted

JOINTS	FOR WM11 FRAME	WALL-MOUNTED
Single	WM65-01B	WM66-01B
Double	WM65-02B	WM66-02B

### TABLET ARM



- Compatible with most tablets on the market
- The clamps and mount have a non-slip surface to keep the tablet stable
- Compatible tablet sizes:
  - Small: 7<sup>5</sup>/<sub>8</sub>"W to 10"W
  - Large: 9<sup>7</sup>/<sub>8</sub>"W to 12<sup>1</sup>/<sub>4</sub>"W
- Tablet can be rotated and tilted
- Includes a heavy-duty articulating arm with one or two joints

JOINTS	TABLET SIZE	FOR WM11 FRAME	WALL-MOUNTED
Single	Small	WM65-01C-01	WM66-01C-01
Single	Large	WM65-01C-02	WM66-01C-02
Double	Small	WM65-02C-01	WM66-02C-01
Double	Large	WM65-02C-02	WM66-02C-02

### IMPORTANT

All models featured below have the following characteristics:

- Color: black
- Height can be easily adjusted, no tools required
- Optimum ergonomics
- Anchoring hardware not included in the wall-mounted version

### LCD MONITOR ARM



- Compatible with most LCD monitors (max. 21") on the market
- Complies with VESA 75 and 100 monitor mounting standards
- Includes one or two articulating arm(s) with two joints
- The articulating arm with two joints provides extra adjustment options
- Monitor can be rotated and tilted

PRODUCT NO.	FOR
WM05-03	WM11 Bench Frame
WM06-03	Wall-Mounted

### LAPTOP ARM



- Holds a laptop, electronic device or any other object
- Tray's usable area: 14"W x 12"D
- Includes an articulating arm with two joints
- The articulating arm with two joints provides extra adjustment options
- Tray can be rotated and tilted

PRODUCT NO.	FOR
WM05-42	WM11 Bench Frame
WM06-42	Wall-Mounted

### TABLET ARM



- Compatible with most tablets on the market
- The clamps and mount have a non-slip surface to keep the tablet stable
- Includes an articulating arm with two joints
- The articulating arm with two joints provides extra adjustment options
- Tablet can be rotated and tilted
- Compatible tablet sizes:
  - Small: 7 $\frac{3}{8}$ "W to 10"W
  - Large: 9 $\frac{7}{8}$ "W to 12 $\frac{1}{4}$ "W

TABLET SIZE	FOR WM11 FRAME	WALL-MOUNTED
Small	WM05-62-01	WM06-62-01
Large	WM05-62-02	WM06-62-02

### LCD MONITOR ARM AND KEYBOARD & MOUSE ARM



- Holds a computer monitor, keyboard and mouse
- Keyboard tray's usable area: 23 $\frac{3}{8}$ "W x 8 $\frac{1}{2}$ "D
- Includes an articulating arm with a single joint and an articulating arm with two joints
- The articulating arm with two joints provides extra adjustment options
- Compatible with most LCD monitors (max. 21") on the market
- Complies with VESA 75 and 100 monitor mounting standards
- Screen and tray can be rotated and tilted

DESCRIPTION	FOR WM11 FRAME	WALL-MOUNTED
Complete kit	WM05-22	WM06-22
LCD Monitor Arm	WM05-02	WM06-02
Keyboard & Mouse Arm	WM05-32	WM06-32

### LCD MONITOR MOUNT AND KEYBOARD & MOUSE TRAY



- Holds a computer monitor, keyboard and mouse
- Keyboard tray's usable area: 23 $\frac{3}{8}$ "W x 8 $\frac{1}{2}$ "D
- Includes an articulating arm with a single joint
- Compatible with most LCD monitors (max. 21") on the market
- Complies with VESA 75 and 100 monitor mounting standards
- Screen and tray can be rotated and tilted

PRODUCT NO.	DESCRIPTION
WM06-21	Wall-Mounted Kit
WM06-01	LCD Monitor Mount
WM06-31	Keyboard & Mouse Arm





CDSA, City of Quebec



The unique and highly functional common post is the cornerstone of the structure. Its unique tubular T shape provides up to seven fixing zones for different applications. It also has a hollow center to prevent interference between sections.



Record storage units can be combined with the industrial Spider® Shelving System.

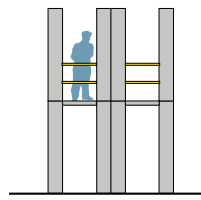

All vertical space can be put to use by combining the Spider® record storage system with two-level shelving.



Shelves are installed on the posts with compression clips. The beams hook onto the front of the post and can support steel, wood and wire mesh decking.

INDEX	PAGE(S)
Record Storage	260
Preconfigured Models . . . . .	261
Components . . . . .	262-263

## RECORD STORAGE

With a Rousseau record storage system, wasted space is no longer a problem. Our shelving system was specially designed to accommodate all popular sizes of record storage boxes. Thanks to the design of the system's unique post, our system is also fully compatible with all other industrial shelving accessories.

Do you need more storage space than you originally thought? With catwalk mezzanines and deck-over shelving, our multi-level shelving systems could be exactly what you're looking for. Talk to one of our specialists to find a solution tailored to your unique requirements.

NOTE: The unique design of the Spider® post is a trademark of Rousseau Metal Inc.

## SHELVING FOR RECORD STORAGE

- Capacity: up to 48 boxes (12"W×15"D×10¼"H each)
- Order double stacked models with four shelves (right) for light boxes, and single stacked models with eight shelves (left) for heavier boxes
- System has been designed for high-rise shelving
- Four or eight shelves depending on the model
- Boxes not included
- To order a back-to-back unit, add B to the product number

### DOUBLE STACKED

STARTER UNIT	ADD-ON UNIT	W×D×H	NO. OF BOXES/LEVEL	NO. OF SHELVES	TOTAL BOXES/UNIT	LOAD CAPACITY PER SHELF
SRD8050_	SRA8050_	42"×15"×75"	6	4	24	650 lb.
SRD8051_	SRA8051_	42"×30"×75"	12	4	48	600 lb.



### SINGLE STACKED

STARTER UNIT	ADD-ON UNIT	W×D×H	NO. OF BOXES/LEVEL	NO. OF SHELVES	TOTAL BOXES/UNIT	LOAD CAPACITY PER SHELF
SRD8052_	SRA8052_	42"×15"×87"	3	8	24	650 lb.
SRD8053_	SRA8053_	42"×30"×87"	6	8	48	600 lb.

## MINI-RACKING FOR RECORD STORAGE

- Capacity: up to 80 boxes (12"W×15"D×10¼"H each)
- Save between 10% and 15% of shelving space compared to similar products on the market
- Four levels with medium-duty beams
- Total height with boxes: 95", suitable for 8'H spaces Height without boxes: 75"
- Boxes not included
- To order a unit with steel decking, add S to the product number
- To order a unit without decking (e.g., for use with wood decking), leave the product number as is

STARTER UNIT	ADD-ON UNIT	W×D×H	NO. OF BOXES/LEVEL	NO. OF SHELVES	TOTAL BOXES/UNIT	LOAD CAPACITY PER SHELF
SRD8005_	SRA8005_	42"×16"×75"	6	4	24	1000 lb.
SRD8006_	SRA8006_	42"×32"×75"	12	4	48	1025 lb.
SRD8003_	SRA8003_	66"×15"×75"	10	4	40	725 lb.
SRD8007_	SRA8007_	66"×16"×75"	10	4	40	725 lb.
SRD8004_	SRA8004_	66"×30"×75"	20	4	80	700 lb.
SRD8008_	SRA8008_	66"×32"×75"	20	4	80	700 lb.



NOTE: \*Wood decking is not available from Rousseau.

# COMPONENTS

## POSTS, BRACES AND BOX SHELVES

### SHELVING AND MINI-RACKING POSTS SR10 / SH10



SH SR

- Tubular T shape
- provides up to seven fixing zones
- Includes perforations spaced 1" apart c/c on each side for easy adjustment of shelves
- 14ga steel
- Options:
  - SR10 universal post with perforated front surface for adding Mini-Racking or multi-level shelving
  - SH10 shelving post with smooth front surface for a neater finish

SR POST	SH POST	HEIGHT
SR10-075	SH10-075	75"
SR10-087	SH10-087	87"
SR10-099	SH10-099	99"
SR10-111	SH10-111	111"
SR10-123	SH10-123	123"

NOTES: Other sizes are available. Contact your customer service representative for more information.

SH posts are for shelving applications only.

The unique design of the Spider® post is a trademark of Rousseau Metal Inc.

### BACK SWAY BRACE SH33



- X-shaped factory-assembled brace
- Easy to install
- Recommendations:
  - For 99"H uprights and shorter: one brace
  - For uprights higher than 99"H: two braces

PRODUCT NO.	WIDTH
SH33-42	42"

NOTE: Please refer to technical guide S58 or contact your customer service representative for exact placement of the brace.

### MINI-RACKING LADDER BRACES SR30

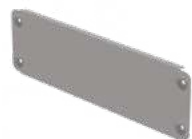

Single ladder brace for 15"D and 16"D units



Double interlocked ladder brace for 30"D and 32"D units

- Sold in pairs
- Recommendations:
  - One pair per 99"H upright and shorter
  - For uprights higher than 99"H, please contact your customer service representative
- For 30"D and 32"D units, the ladder braces interlock as shown. The pair of ladder braces supplied with these models are double ladder braces

PRODUCT NO.	DEPTH
SR30-15	15"
SR30-16	16"
SR30-30	30"
SR30-32	32"

### SIDE BRACES SH34

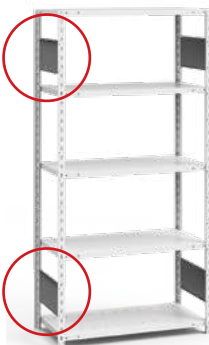

- Sold in pairs
- Enables uprights to be attached in a "ladder" for easier assembly
- Recommendations:
  - 99"H uprights or shorter: one pair of side braces
  - For uprights higher than 99"H: please refer to technical guide S58 or contact your customer service representative

PRODUCT NO.	DEPTH
SH34-15	15"
SH34-30	30"

### BOX SHELF SH20 / SH21



SH60

- BOX-type shelf with roll-formed and welded front and back edges
- 20ga steel Thickness: 1 1/4"
- Includes four sturdy and compact SH60 clips
- Includes perforations spaced 3" apart c/c for installing dividers

PRODUCT NO.	W x D	LOAD CAPACITY*
SH20-4215	42" x 15"	650 lb.
SH21-4230	42" x 30"	600 lb.

NOTE: \* Shelving load capacity tests are based on ANSI MH28.1 Shelving Manufacturer Association (SMA) standards. These load capacities include a safety factor and are valid for an evenly distributed load.

### BACK-TO-BACK SPACERS SR48



- Sold in pairs
- For joining two Mini-Racking sections back to back with a 1" space between posts for beam adjustment

PRODUCT NO.
SR48

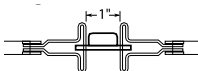

CDSA, City of Québec



## BEAMS, TIE BARS AND WOOD DECKING

### MEDIUM-DUTY BEAMS

SR21

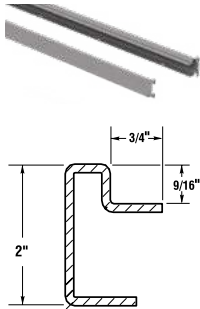

- Sold in pairs
- 14ga steel
- Install on the front of posts. Height can be adjusted in 2" increments c/c
- Held in place with two safety clips

PRODUCT NO.	W × H
SR21-42	42" × 2"
SR21-66	66" × 2"

### MEDIUM-DUTY TIE BAR

SR25 / SR26



- Hooks onto the inside of SR21 beams
- Galvanized steel

PRODUCT NO.	DEPTH
SR25-15	15"
SR25-16	16"
SR25-30	30"
SR25-32	32"

### WOOD DECKING DIMENSIONS AND LOAD CAPACITIES

Wood panels must be cut to the dimensions specified in this chart.

UPRIGHT ASSEMBLY DEPTH	BEAM WIDTH (LOAD CAP. IN LB.)*		NO. OF TIE BARS
	42"	66"	
15"	40 3/4" × 14 1/8" (1000)	64 3/4" × 14 1/8" (725)	1
16"	40 3/4" × 15 1/8" (1000)	64 3/4" × 15 1/8" (725)	1
30"	40 3/4" × 29 3/8" (1025)	64 3/4" × 29 3/8" (700)	2
32"	40 3/4" × 31 3/8" (1025)	64 3/4" × 31 3/8" (700)	2

Mini-Racking units in these sizes can be joined to back-to-back shelving units of the same depth.

Wood decking is not available from Rousseau. Our beams are designed to support plywood or particle board panels at least 5/8" thick.

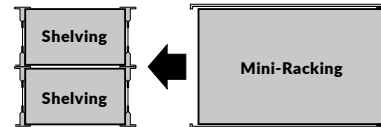

NOTE: \*Shelving load capacity tests are based on ANSI MH28.2 Shelving Manufacturer Association (SMA) standards. These load capacities include a safety factor and are valid for an evenly distributed load. The capacities specified are in pounds.

## INSTALLATION ACCESSORIES

### FLOOR ANCHOR PLATE

SH45



- Sold individually
- Attaches to the post for anchoring shelving sections to the ground. Distributes the load over a larger surface and protects the floor
- 12ga steel

PRODUCT NO.
SH45

### SHIM PLATE

SH46



- Sold individually
- Levels shelving units on uneven surfaces  
Slides under SH45 floor anchor plates
- 12ga or 16ga galvanized steel

PRODUCT NO.	THICKNESS
SH46-12	12 gauge (0.100")
SH46-16	16 gauge (0.060")

### FLOOR ANCHORING HARDWARE

SH47



- Anchors shelving to the ground
- Includes four bolts for concrete floors

PRODUCT NO.
SH47-04

### WALL SPACER

SR47



- Anchors shelving to the wall
- Adjusts from 3" to 4"
- Wall anchoring hardware not included (holes are 5/16" dia.)

PRODUCT NO.
SR47-0304



## MULTI-LEVEL SHELVING

Not enough space? Before you embark on an expansion project, consider Rousseau multi-level shelving, which makes efficient use of vertical space, as well as depth and width.

Our specialists will suggest solutions to work around all your building's obstacles: beams, columns, doors, air ducts, building structure, etc.

Rousseau multi-level shelving maximizes your storage potential by combining shelving, modular drawers and Mini-Racking, and adapting everything to your inventory. The system allows you to store more parts in less space, while also reducing trips back and forth and therefore wasted time.

Big challenges need big solutions!



## EXPERTISE THAT LEAVES NOTHING TO CHANCE

### IMPORTANT

Multi-level shelving systems are subject to standards and recommendations in earthquake-prone regions. Rousseau project managers are available to help you work out what shelving and sway bracing you need and help complete your multi-level shelving project. Call Rousseau's sales department and ask to speak to one of our project managers..

NOTE: For technical specifications, please refer to technical guide S05 Multi-Level Shelving.

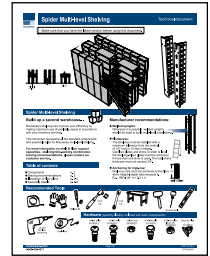

## SOLUTIONS

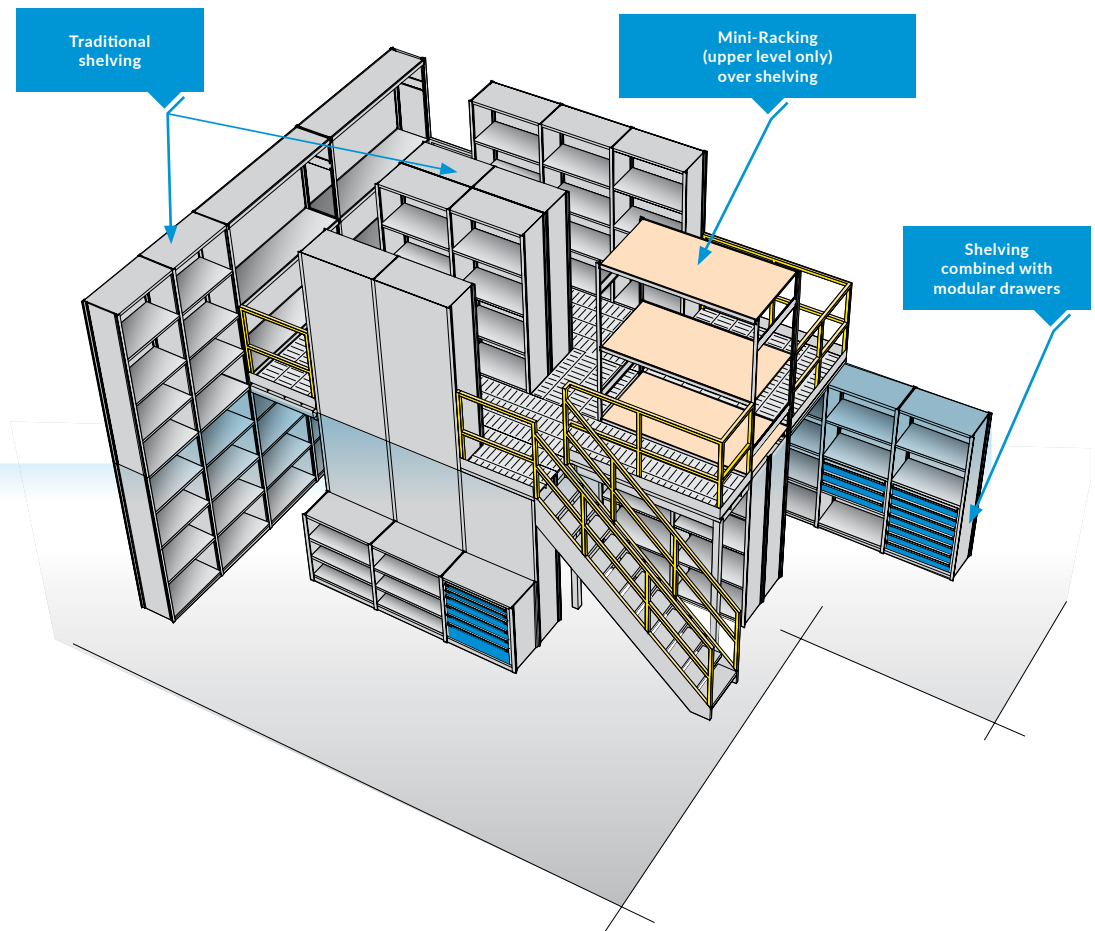
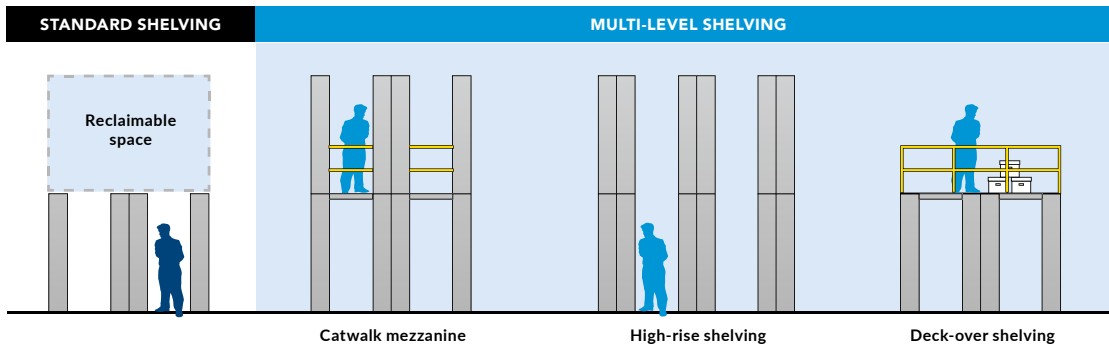

### UPPER LEVEL

Sturdy long-span or standard shelves for bulky material.

### LOWER LEVEL

Shelving with dividers and modular drawers for small or rapid turnover items.

NOTE: Stairs, guardrails and ramps are not supplied by Rousseau.

# STACK & STORE CABINET MEZZANINE

## MORE STORAGE, SAME FLOOR SPACE

Our Stack & Store Cabinet Mezzanine is a turnkey solution and includes: ground-level cabinets, stacked cabinets, floor panels, railing and stairs.

It provides easily accessible high-density storage on two levels.

It is quick and easy to install, and the ground-level cabinets are pre-drilled for easy installation of the railing and floor panels. It can also be moved or reconfigured as needed.



**UPPER LEVEL**  
Items with lower turnover and/or lighter

**LOWER LEVEL**  
Items with higher turnover and/or heavier

## CABINET HOUSING FOR MEZZANINE

RA38



- Compatible with modular drawers, roll-out shelves, adjustable shelves and bottom shelves
- Includes 8 holes on top for securing RA91 railing and RA93 floors, and for the option of stacking cabinets
- Includes a concrete-floor anchoring kit for cabinet housings and bases, and hardware for stacking cabinets
- An RA52 base is required, [see page 20](#)
- For factory installation of an electronic lock, order an RB00-DDHHL50, [see page 11](#)
- To order a One-Drawer-at-a-Time mechanism, add A to the product number



PRODUCT NO.	W×D×H	TYPE OF LOCK
RA38-302758L3_	30"×27"×58"	Keys
RA38-302758LP_	30"×27"×58"	Safety hasp

NOTES: The height specified refers to the height of the housing excluding the base.  
For RA30 housing units, [see page 19](#).  
30"D housing also available. Contact Customer Service.

## END RAILING

RA92



- The railing complies with 42"H safety standards

PRODUCT NO.	D×H
RA92-30	30"×42"

## FILLER

RA94



- Fills the space between back-to-back cabinets
- Two heights available: 58"H housings with 2" base (total 60"H) or 4" base (total 62"H)
- Installs at an aisle end without stairs (not compatible with stairs)

PRODUCT NO.	D×H
RA94-03060	3"×60"
RA94-03062	3"×62"

## CABINET SPACER

RA96



- Maintains a consistent space between back-to-back cabinets
- Order an RA96 for each cabinet under the floor
- Anchoring hardware included

PRODUCT NO.	DEPTH
RA96-03	3"

## STAIRS

RA90

- Includes six 9½"D treads
- Clear width of 26½"
- Galvanized steel treads with non-slip surface
- Two heights available: 58"H housings with 2" base (total 60"H) or 4" base (total 62"H)
- One or two handrails

PRODUCT NO.	W×D×H	NO. OF HANDRAILS
RA90-306060-01	30"×60"×60"	1
RA90-306060-02	30"×60"×60"	2
RA90-306062-01	30"×60"×62"	1
RA90-306062-02	30"×60"×62"	2



1 handrail



2 handrails

## AISLE RAILING

RA91



- The railing complies with 42"H safety standards
- Installs in the pre-drilled holes in RA38 housings

PRODUCT NO.	W×H
RA91-30	30"×42"
RA91-60	60"×42"

## FLOOR PANEL

RA93



- Heavy-duty wood fiber floor section
- Stain and scratch resistant
- Easy-to-clean, non-slip surface

PRODUCT NO.	W×D
RA93-3030	30"×30"
RA93-6030	60"×30"

## FLOOR ANCHOR AND SHIM PLATES

RA95 / RA97



- 12ga galvanized steel
- The RA95 floor anchor plate acts as a base for anchoring the stair to the ground
  - Sold in pairs
  - Includes floor anchoring hardware
- The RA97 shim plate is used to level the stairs. It slides under the floor anchoring plate
  - Sold individually

PRODUCT NO.	TYPE
RA95-01	Floor Anchor Plate
RA97-12	Shim Plate

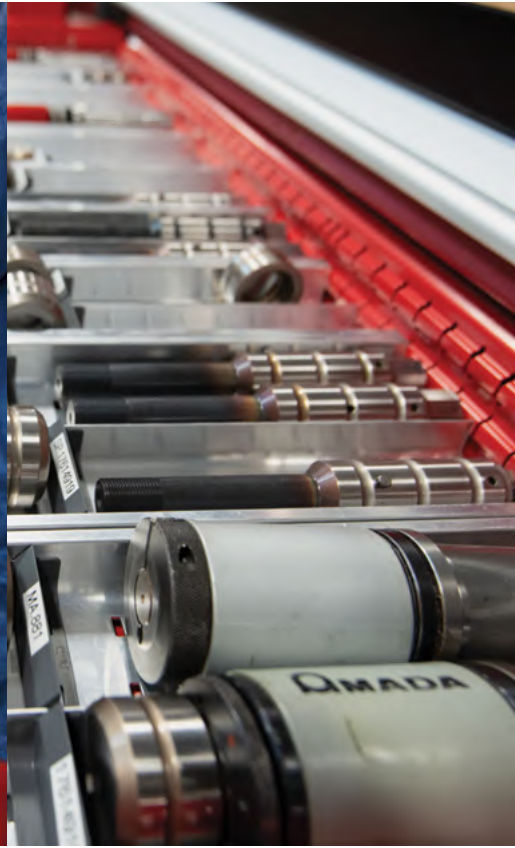

INDEX	PAGE(S)
<b>MANUFACTURING TOOL STORAGE</b>	<b>268-269</b>
<b>Machining Tool Storage</b>	<b>270</b>
Preconfigured Models . . .	271-273
Components . . . . .	274-279
<b>Punching Tool Storage</b>	<b>280</b>
Preconfigured Models . . .	281-284
Components . . . . .	283-284
<b>Bending Tool Storage</b>	<b>285</b>
Preconfigured Models . . .	286-289
Components . . . . .	290-291

## MANUFACTURING TOOL STORAGE SYSTEM

Manufacturing and processing steel (via machining, punching and bending) has been part of our business since 1950. Because of our vast experience in this sector, we fully understand the challenges associated with managing and storing the tools used.

These tools are a significant investment, so we have created a wide variety of storage solutions specially designed to provide maximum protection while optimizing and increasing the density of the storage.

We have leveraged our tool storage expertise to develop storage lines for punching and bending tools.

Whether you work with all these tools or specialize in just one of these areas, we are sure you will find a Rousseau storage solution that meets your needs.

## MACHINING TOOLS



## PUNCHING TOOLS



## BENDING TOOLS



# MACHINING TOOL STORAGE SOLUTIONS

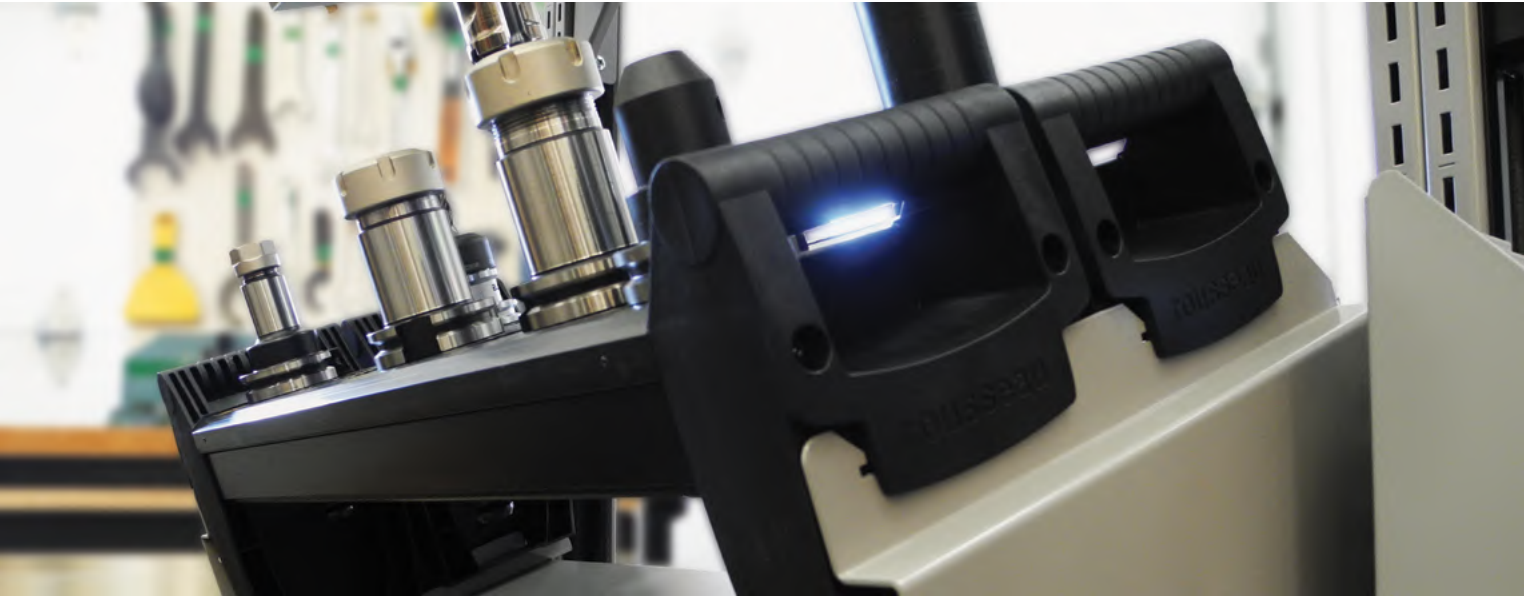

## MACHINING TOOL STORAGE

With the flexibility of our Machining Tool Storage line, your tools are always protected during regular handling, transportation and storage. Rousseau's CNC tool rack is unique in many ways, it is:

- **Modular:** It is compatible with the entire Rousseau product range
- **Adaptable:** Available blank or with perforations, it can be adapted to any type of tool
- **Sturdy:** Maximum support and stability prevents tools from falling, even when the rack is tilted

- **Ergonomic:** Practical, ergonomic handles make it easy to carry. The 20° angled adapters facilitate handling of parts in Spider® Shelving and on WM uprights
- **Secure:** With its resistant PVC extruded design, it can withstand blows and corrosion, and allows fluids to drain away, which prolongs the life of your tools

The racks also feature a tool identification zone for quick and easy tool retrieval.





**IMPORTANT**

CNC tool storage products include blank tool racks by default. To order models with perforated racks, contact Customer Service or consult the Price Tool on e-Rousseau

## 87"H SHELVING WITH MODULAR DRAWERS



NCS2392

PRODUCT NO.	W×D×H	NO. OF RACKS
NCS2392	30"×24"×87"	8

- 1 drawer, 3"H with groove trays
- 1 drawer, 4"H with foam for collets
- 1 drawer, 4"H with compartments
- 2 drawers, 7"H with adapters
- 5 shelves
- 1 set of 48"H mounting brackets
- 4 shelf dividers
- 2 welded closed uprights
- 1 front base
- 4 floor anchor plates
- 1 floor anchoring hardware kit
- 2 back panels
- 8 blank NC tool racks



Shelving with drawers must be anchored to the floor (anchor kit included).

## 75"H SHELVING WITH ADAPTERS



NCS4195



NCS4196

PRODUCT NO.	W×D×H	NO. OF RACKS
NCS4195	36"×18"×75"	9

- 3 shelves
- 3 pairs of tool rack adapters
- 2 shelf dividers
- 2 welded closed uprights
- 1 front base
- 4 floor anchor plates
- 1 floor anchoring hardware kit
- 2 back panels
- 9 blank NC tool racks

PRODUCT NO.	W×D×H	NO. OF RACKS
NCS4196	36"×18"×75"	9

- 3 shelves
- 3 pairs of tool rack adapters
- 2 shelf dividers
- 2 welded closed uprights
- 1 front base
- 4 floor anchor plates
- 1 floor anchoring hardware kit
- 2 back panels
- 9 blank NC tool racks
- Polycarbonate doors with frame and L3 lock



Multi-level shelving is not recommended if first-level shelving only contains tool racks and two shelves.

## MINI-RACKING



NCS6194

PRODUCT NO.	W×D×H
NCS6194	60"×24"×87"

- 5 pairs of heavy-duty beams
- 2 welded Mini-Racking uprights
- 5 heavy-duty tie bars
- 2 steel decking levels
- 3 blank PVC decking levels

NOTES: Load capacity per steel decking level: 1,925lb.  
Load capacity per PVC decking level: 1,000lb.

**IMPORTANT**

This CNC tool storage product includes NC33 blank tool decking by default. To order a model with NC34 perforated decking, contact Customer Service or consult the Price Tool on e-Rousseau.

# PRECONFIGURED MODELS

### IMPORTANT

CNC tool storage products include blank tool racks by default. To order models with perforated racks, contact Customer Service or consult the Price Tool on e-Rousseau

## MOBILE CABINET



NCM8195

PRODUCT NO.	W×D×H	NO. OF RACKS
NCM8195	36"×24"×61½"	2

- 1 cabinet with standard lock
- 1 laminated hardwood top
- 1 pair of 6" rigid casters
- 1 pair of 6" swivel casters with total-lock brake
- 1 side handle
- 5 drawers with integrated lock-in mechanism
  - 2 drawers, 4"H
  - 3 drawers, 6"H
- 1 single WM frame
- 1 foldaway shelf
- 2 standard WM tool rack adapters
- 2 blank NC tool racks

NOTE: Drawer compartments are not included and must be ordered separately, [see page 231](#).

## MODULAR CABINET



NCM0097

PRODUCT NO.	W×D×H	NO. OF RACKS
NCM0097	36"×24"×60"	12

- 1 cabinet with One-Drawer-at-a-Time system
- 1 forklift base, 2"H
- 3 drawers, 7"H with adapters
- 12 blank NC tool racks

## WORKSTATION WITH WM BENCH FRAME



NCW0598

PRODUCT NO.	W×D×H	NO. OF RACKS
NCW0598	60"×30"×80"	3

- 1 double WM bench frame
- 2 tiltable shelves
- 3 partial dividers
- 1 power outlet module
- 1 document holder with arm
- 1 utility panel
- 1 panel bracket kit
- 1 pack of 10 double back single hooks
- 1 overhead LED workstation light
- 1 WM tool holder
- 2 WM tool rack adapters:
  - 1 single
  - 1 double
- 1 pair of cantilever overhead supports
- 1 laminated hardwood top
- 1 closed leg, 27"D×32"H
- 1 side panel
- 1 L cabinet, 5 drawers with compartments
  - 2 drawers, 3"H
  - 3 drawers, 6"H
- 3 blank NC tool racks

### IMPORTANT

CNC tool storage products include blank tool racks by default. To order models with perforated racks, contact Customer Service or consult the Price Tool on e-Rousseau

## STATIONARY WM STAND



NCW0259

PRODUCT NO.	W×D×H	NO. OF RACKS
NCW0259	32" × 27" × 54"	8

- 1 WM stand with leveling glides kit
- 4 double WM tool rack adapters
- 2 plastic bin rails
- 2 tiltable shelves
- 6 partial dividers
- 8 blank NC tool racks

NOTE: Red plastic bins are not available from Rousseau.

## MOBILE CART



NCW0109

PRODUCT NO.	W×D×H	NO. OF RACKS
NCW0109	32" × 27" × 41¼"	8

- 1 mobile cart with 4" casters
- 1 shelf with handle
- 4 double WM tool rack adapters
- 8 blank NC tool racks

## R2V CABINET



NCLDG-380001L3A

PRODUCT NO.	W×D×H	NO. OF RACKS
NCLDG-380001L3A	30" × 27" × 38"	10

- 1 R2V cabinet with standard lock
- 2 vertical drawers (11"W)
- 1 vertical drawer (6"W)
- 10 blank NC tool racks



## VTZ CABINET



NCV-GH620001L3

PRODUCT NO.	W×D×H	NO. OF RACKS
NCV-GH620001L3	37½" × 44" × 62"	15

- 1 VTZ cabinet with standard locks
- 5 vertical drawers (7"W)
- 15 blank NC tool racks



## TOOL RACKS

### TOOL RACK FOR WM, DRAWERS AND SHELVING



NC10 / NC12



NC12



NC10

- Perforated or blank rack available
- Made of resistant PVC, the extruded part of the rack protects tools against impacts, corrosion and metal shards
- Widths available: 30" and 36"
- Includes an identification zone for quick and easy tool retrieval
- Compatible with 28"W and 34"W WM11 frames (or two WM10 uprights and a WM15 crossmember) and WMA units with NC50 adapters
- Compatible with WM35 wall-mounted frames with NC50 adapters
- Compatible with RF31, RF32, RF33, RF34, RF35 and RF36 drawers (with NC54 adapters) in the following sizes: 30"W x 21"D, 36"W x 18"D, 30"W x 24"D, 36"W x 24"D, 30"W x 27"D
- Compatible with Spider® shelving (with NC51 adapters) in the following sizes: 30"W x 24"D, 36"W x 18"D, 36"W x 24"D
- Color: black

### SHELVING - WM UPRIGHTS AND FRAMES - CABINETS

CNC tool storage products (see pages 271-273) include NC10 blank tool racks by default. To order models with NC12 perforated racks, contact Customer Service or consult the Price Tool on e-Rousseau.

The following table specifies the product number corresponding to your tool type.

TOOL RACK C/C DIMENSIONS	30"W TOOL RACK 28" C/C		36"W TOOL RACK 34" C/C	
	25 1/4"W x 5"D x 7 1/4"H		31 1/4"W x 5"D x 7 1/4"H	
	ACTUAL DIMENSIONS	25 1/4"W x 5"D x 7 1/4"H	31 1/4"W x 5"D x 7 1/4"H	31 1/4"W x 5"D x 7 1/4"H
TOOL TYPE	PRODUCT NO.	NO. OF HOLES	PRODUCT NO.	NO. OF HOLES
Blank rack	NC10-3000	–	NC10-3600	–
Taper 30	NC12-3001	10	NC12-3601	12
Taper 40	NC12-3003	7	NC12-3603	9
Taper 45	NC12-3004	6	NC12-3604	7
Taper 50	NC12-3005	5	NC12-3605	6
3/4" Straight	NC12-3010	20	NC12-3610	26
1" Straight	NC12-3011	20	NC12-3611	26
1 1/4" Straight	NC12-3013	20	NC12-3613	26
1 1/2" Straight	NC12-3015	8	NC12-3615	10
1 3/4" Straight	NC12-3016	8	NC12-3616	10
2" Straight	NC12-3018	6	NC12-3618	7
2 1/4" Straight	NC12-3019	6	NC12-3619	7
2 1/2" Straight	NC12-3021	6	NC12-3621	7
C3 Sandvik Capto	NC12-3030	22	NC12-3630	26
C4 Sandvik Capto	NC12-3031	22	NC12-3631	26
C5 Sandvik Capto	NC12-3032	10	NC12-3632	12
C6 Sandvik Capto	NC12-3033	7	NC12-3633	9
C8 Sandvik Capto	NC12-3034	6	NC12-3634	7
HSK 25 (A-C-E)	NC12-3040	22	NC12-3640	26
HSK 32 (A-C-E)	NC12-3041	22	NC12-3641	26
HSK 40 (A-C-E)	NC12-3042	22	NC12-3642	26
HSK 50 (A-C-E)	NC12-3043	10	NC12-3643	12
HSK 63 (A-C-E)	NC12-3044	7	NC12-3644	9
HSK 80 (A-C-E)	NC12-3045	5	NC12-3645	6
HSK 100 (A-C-E)	NC12-3046	4	NC12-3646	5
32 KM	NC12-3050	22	NC12-3650	26
40 KM	NC12-3051	22	NC12-3651	26
50 KM	NC12-3052	10	NC12-3652	12
63 KM	NC12-3053	7	NC12-3653	9
80 KM	NC12-3054	5	NC12-3654	6
VDI 30 mm	NC12-3060	6	NC12-3660	7
VDI 40 mm	NC12-3061	5	NC12-3661	6
VDI 50 mm	NC12-3062	4	NC12-3662	5



The rack can support a load of 150lb., but we recommend staying under 50lb. so the rack can be lifted safely

NOTE: The number of tools that a tool rack can hold varies according to tool diameter and the length of extruded surfaces. The number of holes specified in the table indicates the number of perforations per extruded surface.

## TOOL RACK FOR TEKZONE HUTCH

NC14 / NC15



NC15

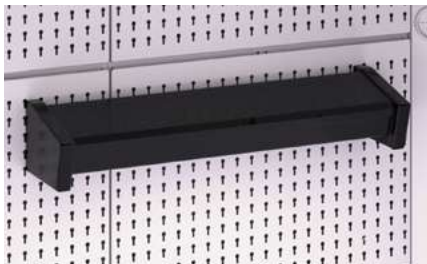

NC14

- Perforated or blank rack available
- Made of resistant PVC, the extruded part of the rack protects tools against impacts, corrosion and metal shards
- Widths available: 23" and 29"
- Includes an identification zone for quick and easy tool retrieval
- Attaches to TekZone Hutch rear utility panels at the desired height
- Color: black

### TEKZONE HUTCH

The following table specifies the product number corresponding to your tool type.

TOOL RACK	23"W TOOL RACK		29"W TOOL RACK	
	23"W x 5"D x 4"H		29"W x 5"D x 4"H	
ACTUAL DIMENSIONS	PRODUCT NO.	NO. OF HOLES	PRODUCT NO.	NO. OF HOLES
Blank rack	NC14-2300	—	NC14-2900	—
Taper 30	NC15-2301	10	NC15-2901	12
Taper 40	NC15-2303	7	NC15-2903	9
Taper 45	NC15-2304	6	NC15-2904	7
Taper 50	NC15-2305	5	NC15-2905	6
¾" Straight	NC15-2310	20	NC15-2910	26
1" Straight	NC15-2311	20	NC15-2911	26
1¼" Straight	NC15-2313	20	NC15-2913	26
1½" Straight	NC15-2315	8	NC15-2915	10
1¾" Straight	NC15-2316	8	NC15-2916	10
2" Straight	NC15-2318	6	NC15-2918	7
2¼" Straight	NC15-2319	6	NC15-2919	7
2½" Straight	NC15-2321	6	NC15-2921	7
C3 Sandvik Capto	NC15-2330	22	NC15-2930	26
C4 Sandvik Capto	NC15-2331	22	NC15-2931	26
C5 Sandvik Capto	NC15-2332	10	NC15-2932	12
C6 Sandvik Capto	NC15-2333	7	NC15-2933	9
C8 Sandvik Capto	NC15-2334	6	NC15-2934	7
HSK 25 (A-C-E)	NC15-2340	22	NC15-2940	26
HSK 32 (A-C-E)	NC15-2341	22	NC15-2941	26
HSK 40 (A-C-E)	NC15-2342	22	NC15-2942	26
HSK 50 (A-C-E)	NC15-2343	10	NC15-2943	12
HSK 63 (A-C-E)	NC15-2344	7	NC15-2944	9
HSK 80 (A-C-E)	NC15-2345	5	NC15-2945	6
HSK 100 (A-C-E)	NC15-2346	4	NC15-2946	5
32 KM	NC15-2350	22	NC15-2950	26
40 KM	NC15-2351	22	NC15-2951	26
50 KM	NC15-2352	10	NC15-2952	12
63 KM	NC15-2353	7	NC15-2953	9
80 KM	NC15-2354	5	NC15-2954	6
VDI 30 mm	NC15-2360	6	NC15-2960	7
VDI 40 mm	NC15-2361	5	NC15-2961	6
VDI 50 mm	NC15-2362	4	NC15-2962	5

NOTE: The number of tools that a tool rack can hold varies according to tool diameter and the length of extruded surfaces. The number of holes specified in the table indicates the number of perforations per extruded surface.

## TOOL RACKS FOR R2V CABINETS

## NC73 / NC74

- Perforated or blank rack available
- Made of resistant PVC, the extruded part of the rack protects tools against impacts, corrosion and metal shards
- Depths available: 24" and 27"
- Includes an identification zone for quick and easy tool retrieval
- Capacity: 50lb
- Color: black

## TOOL RACKS FOR VTZ CABINETS



## NC64

- Perforated or blank rack available
- Made of resistant PVC, the extruded part of the rack protects tools against impacts, corrosion and metal shards
- Depth available: 44"
- Includes an identification zone for quick and easy tool retrieval
- Capacity: 250lb
- Color: black

DIMENSIONS	R2V CABINET				VTZ CABINET	
	24"D TOOL RACK		27"D TOOL RACK		44"D TOOL RACK	
	5"W x 19"D x 2½"H		5"W x 22"D x 2½"H		5½"W x 30"D x 3½"H	
TOOL TYPE	PRODUCT NO.	NO. OF HOLES	PRODUCT NO.	NO. OF HOLES	PRODUCT NO.	NO. OF HOLES
Blank rack	NC73-2400	—	NC73-2700	—	NC64-0704400	—
Taper 30	NC74-2401	8	NC74-2701	10	NC64-0704401	15
Taper 40	NC74-2403	6	NC74-2703	7	NC64-0704403	11
Taper 45	NC74-2404	5	NC74-2704	6	NC64-0704404	9
Taper 50	NC74-2405	4	NC74-2705	5	NC64-0704405	7
¾" Straight	NC74-2410	18	NC74-2710	20	NC64-0704410	32
1" Straight	NC74-2411	18	NC74-2711	20	NC64-0704411	32
1½" Straight	NC74-2413	18	NC74-2713	20	NC64-0704413	32
1½" Straight	NC74-2415	7	NC74-2715	8	NC64-0704415	13
1¾" Straight	NC74-2416	7	NC74-2716	8	NC64-0704416	13
2" Straight	NC74-2418	5	NC74-2718	6	NC64-0704418	9
2½" Straight	NC74-2419	5	NC74-2719	6	NC64-0704419	9
2½" Straight	NC74-2421	5	NC74-2721	6	NC64-0704421	9
C3 Sandvik Capto	NC74-2430	18	NC74-2730	20	NC64-0704430	32
C4 Sandvik Capto	NC74-2431	18	NC74-2731	20	NC64-0704431	32
C5 Sandvik Capto	NC74-2432	8	NC74-2732	10	NC64-0704432	15
C6 Sandvik Capto	NC74-2433	6	NC74-2733	7	NC64-0704433	11
C8 Sandvik Capto	NC74-2434	5	NC74-2734	6	NC64-0704434	9
HSK 25 (A-C-E)	NC74-2440	18	NC74-2740	20	NC64-0704440	32
HSK 32 (A-C-E)	NC74-2441	18	NC74-2741	20	NC64-0704441	32
HSK 40 (A-C-E)	NC74-2442	18	NC74-2742	20	NC64-0704442	32
HSK 50 (A-C-E)	NC74-2443	8	NC74-2743	10	NC64-0704443	15
HSK 63 (A-C-E)	NC74-2444	6	NC74-2744	7	NC64-0704444	11
HSK 80 (A-C-E)	NC74-2445	4	NC74-2745	5	NC64-0704445	7
HSK 100 (A-C-E)	NC74-2446	3	NC74-2746	4	NC64-0704446	6
32 KM	NC74-2450	18	NC74-2750	20	NC64-0704450	32
40 KM	NC74-2451	18	NC74-2751	20	NC64-0704451	32
50 KM	NC74-2452	8	NC74-2752	9	NC64-0704452	15
63 KM	NC74-2453	6	NC74-2753	7	NC64-0704453	11
80 KM	NC74-2454	4	NC74-2754	5	NC64-0704454	7
VDI 30 mm	NC74-2460	5	NC74-2760	6	NC64-0704460	9
VDI 40 mm	NC74-2461	4	NC74-2761	5	NC64-0704461	8
VDI 50 mm	NC74-2462	3	NC74-2762	4	NC64-0704462	6



NC73



NC64



**IMPORTANT**  
Refer to technical guide N50 for recommended layouts based on tool height and intended use.

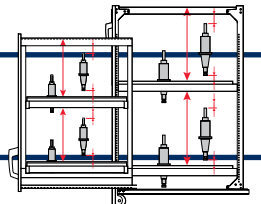

## TOOL RACK ADAPTERS

### WM ADAPTER

NC50



- Adapters for installing NC10 and NC12 tool racks in WM11 frames with uprights spaced 28" and 34" apart c/c (or two WM10 uprights and one WM15 crossmember) or in WMA stands, [see pages 163 and 211](#);
- For installing NC10 and NC12 tool racks in WM35 wall-mounted multi-purpose frames, [see page 213](#);
- Side security notches in the WM adapter ensure tool rack stability
- Angled forward 20° for easy access to tools
- Single and double models in two widths available for one or two racks respectively, 30" (for 28" c/c widths) and 36" (for 34" c/c widths)
- Easy assembly, no tools required

PRODUCT NO.	TYPE	WIDTH	CAPACITY
NC50-2801	Single	28" c/c	150lb
NC50-2802	Double	28" c/c	300lb
NC50-3401	Single	34" c/c	150lb
NC50-3402	Double	34" c/c	300lb

### TOOL RACK SHELVING ADAPTERS

NC54



- Sold in pairs
- Adapters for installing NC10 and NC12 tool racks in 7"H heavy-duty drawers (RF31 / RF32 / RF35 / RF36) or in 10"H, 12"H or 14"H drawers for CNC tools (RF33 / RF34), [see page 220](#)
- Compatible with modular drawers of the following sizes: 30"W x 21"D, 30"W x 24"D, 30"W x 27"D, 36"W x 18"D and 36"W x 24"D
- The adapters prevent the tool racks from tipping when door is opened or closed
- Supports three or four NC10 or NC12 tool racks
- Galvanized steel
- Easy assembly, no tools required

PRODUCT NO.	DEPTH	NO. OF RACKS	CAPACITY
NC54-1801	18"	3	400lb
NC54-2101	21"	3	
NC54-2401	24"	4	
NC54-2701	27"	4	

### TOOL RACK SHELVING ADAPTERS

NC51

- Sold in pairs
- Adapters for installing NC10 and NC12 tool racks in 30"W x 24"D, 36"W x 18"D and 36"W x 24"D Spider® Shelving, [see page 88](#)
- Angled forward 20° for easy access to tools
- Supports three or four NC10 or NC12 tool racks
- Compatible with Spider® shelving only
- Galvanized steel
- Easy assembly, no tools required

PRODUCT NO.	DEPTH	NO. OF RACKS	CAPACITY
NC51-1801	18"	3	450lb
NC51-2401	24"	4	600lb



### HEAVY-DUTY DRAWER FOR CNC TOOLS

RF33 / RF34



- Heavy-duty drawer for cabinets: RF33
- Heavy-duty drawer for shelving: RF34
- Closed front and open sides for easy insertion and removal of NC10 and NC12 tool racks
- Heights available: 10", 12" and 14"
- To order: Add the drawer height required to the product number, e.g., RF33-302714.

PRODUCT NO.	W x D	APPLICATION
RF33-3021__	30" x 21"	cabinet
RF33-3027__	30" x 27"	cabinet
RF33-3618__	36" x 18"	cabinet
RF33-3624__	36" x 24"	cabinet
RF34-3024__	30" x 24"	shelving*
RF34-3618__	36" x 18"	shelving*
RF34-3624__	36" x 24"	shelving*

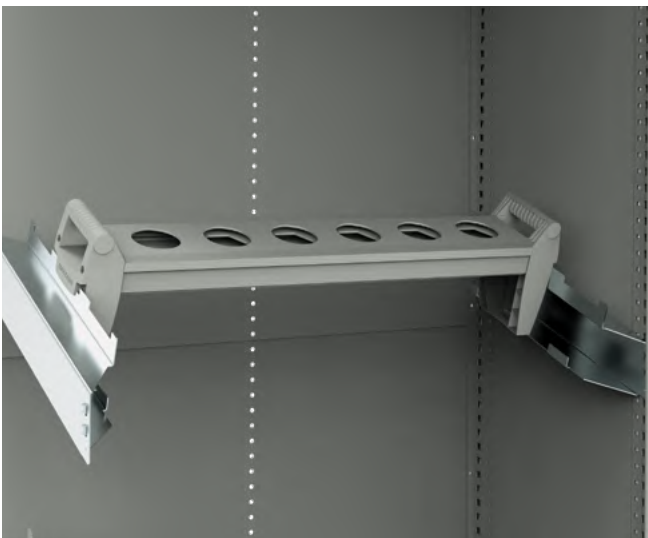

NOTES: \*Mounting brackets are required to install drawers in shelving, [see page 135](#).  
NC54 Adapters must be ordered separately.



NCS6024

PVC deck sections for Mini-Racking must be ordered separately from preconfigured models. The following table specifies the product number corresponding to your tool type.

Made of resistant PVC, the extruded part of the deck section protects tools against impacts, corrosion and metal shards.

The number of tools a PVC deck can hold varies according to tool diameter and the extruded surface length. The number of holes specified in the table indicates the number of perforations per extruded surface.

- Deck section with blank (NC30) or perforated (NC31) surfaces available
- 6"W sections
- Load capacity for an 18"D PVC deck Section: 75lb.
- Load capacity for a 24"D PVC deck Section: 100lb.
- PVC deck sections can be combined with SR40 steel decking on the same level
- 6"W deck Section do not include label holders

**IMPORTANT**  
Refer to technical guide N50 for recommended layouts based on tool height and intended use.

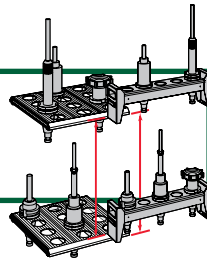

NC30



NC31

## 6"W DECK SECTIONS

TOOL TYPE	TOOL CODE	18"D PVC DECK SECTION		24"D PVC DECK SECTION	
		PRODUCT NO.	NO. OF HOLES	PRODUCT NO.	NO. OF HOLES
Blank rack	00	NC30-1800	—	NC30-2400	—
Taper 30	01	NC31-1801	8	NC31-2401	10
Taper 40	03	NC31-1803	7	NC31-2403	9
Taper 45	04	NC31-1804	4	NC31-2404	5
Taper 50	05	NC31-1805	4	NC31-2405	5
¾" Straight	10	NC31-1810	14	NC31-2410	18
1" Straight	11	NC31-1811	14	NC31-2411	18
1¼" Straight	13	NC31-1813	14	NC31-2413	18
1½" Straight	15	NC31-1815	5	NC31-2415	7
1¾" Straight	16	NC31-1816	5	NC31-2416	7
2" Straight	18	NC31-1818	4	NC31-2418	5
2¼" Straight	19	NC31-1819	4	NC31-2419	5
2½" Straight	21	NC31-1821	4	NC31-2421	5
C3 Sandvik Capto	30	NC31-1830	18	NC31-2430	24
C4 Sandvik Capto	31	NC31-1831	18	NC31-2431	24
C5 Sandvik Capto	32	NC31-1832	7	NC31-2432	9
C6 Sandvik Capto	33	NC31-1833	7	NC31-2433	9
C8 Sandvik Capto	34	NC31-1834	4	NC31-2434	5
HSK 25 (A-C-E)	40	NC31-1840	18	NC31-2440	24
HSK 32 (A-C-E)	41	NC31-1841	18	NC31-2441	24
HSK 40 (A-C-E)	42	NC31-1842	18	NC31-2442	24
HSK 50 (A-C-E)	43	NC31-1843	8	NC31-2443	10
HSK 63 (A-C-E)	44	NC31-1844	5	NC31-2444	7
HSK 80 (A-C-E)	45	NC31-1845	4	NC31-2445	5
HSK 100 (A-C-E)	46	NC31-1846	3	NC31-2446	4
32 KM	50	NC31-1850	18	NC31-2450	24
40 KM	51	NC31-1851	18	NC31-2451	24
50 KM	52	NC31-1852	8	NC31-2452	10
63 KM	53	NC31-1853	5	NC31-2453	7
80 KM	54	NC31-1854	4	NC31-2454	5
VDI 30 mm	60	NC31-1860	7	NC31-2460	9
VDI 40 mm	61	NC31-1861	4	NC31-2461	5
VDI 50 mm	62	NC31-1862	3	NC31-2462	4



PVC decking for Mini-Racking must be ordered separately from preconfigured models. Made of resistant PVC, the extruded part of the decking protects tools against impacts, corrosion and metal shards.

To find out the number of tools you can store in perforated decking, multiply the number of perforated deck sections in your decking by the number of holes in an NC31 deck section, see page 278.

- Decking with perforated (NC33) or blank (NC34) surfaces available
- Models for 48"W, 60"W and 72"W Mini-Racking levels available. Perforated model numbers must be completed with the tool code
- Load capacity for an 18"D PVC deck section: 75lb.
- Load capacity for a 24"D PVC deck section: 100lb.
- PVC decking can be combined with SR40 steel decking on the same level
- The decking includes an NC32 label holder
- To order NC34 decking, complete the product number with the tool code, see page 278, e.g., NC34-602405 for 60"W×24"D decking for Taper 50 tools



NC33



NC34

### DECKING COMPOSED OF INDIVIDUAL 6"W DECK SECTIONS

BEAM WIDTH	DECK SECTION DEPTH	BLANK SURFACE (NC30 DECK SECTION)	PERFORATED SURFACE (NC31 SDECK SECTION)	NO. OF DECK SECTIONS
48"	18"	NC33-481800	NC34-4818_ _	8
	24"	NC33-482400	NC34-4824_ _	
60"	18"	NC33-601800	NC34-6018_ _	10
	24"	NC33-602400	NC34-6024_ _	
72"	18"	NC33-721800	NC34-7218_ _	12
	24"	NC33-722400	NC34-7224_ _	



# PUNCHING TOOL STORAGE SOLUTIONS



## PUNCHING TOOL STORAGE

Rousseau's storage system for punching tools has been specially designed to provide efficient and organized storage for type A, B, C, D and E (thick turret) tools.

Whether you need to store your tools close to your machines, transport them for maintaining them (sharpening and lubrication),

inspect them before using them, or perform quality control on manufactured parts, we have a solution for you.

To optimize and increase the density of your tool storage, we recommend three solutions depending on the type of punch and die you use.

STORAGE TYPE	TOOL POSITION	TOOLS ASSEMBLED	
Storage trays	Tools lie flat	Assembled or non-assembled	
Partitions and dividers	Tools upright	Non-assembled	
Punching tool racks	Dies lie flat or upright and punches are upright <sup>1</sup>	Non-assembled but grouped together	



NOTE: <sup>1</sup> See page 284, for more details.



The drawer interior layouts included in the preconfigured cabinet models are labeled 1 to 8 and can be found on [pages 283-284](#).

## 32" HIGH (W x D x H)

Width  
30" 36"



Width  
30" 36"  
4" 1 5  
4" 2 6  
4" 3 7  
7" 4 8  
7" 4 8

5 DRAWERS

N5PADG-3001L3	30" x 27" x 32"	1 2 4
N5PAEG-3001L3	36" x 27" x 32"	5 6 8



Width  
30" 36"  
4" 1 5  
4" 3 7  
7" 4 8  
11"

4 DRAWERS

N5PADG-3002L3	30" x 27" x 32"	1 3 4
N5PAEG-3002L3	36" x 27" x 32"	5 7 8



Width  
30" 36"  
4" 2 6  
7" 4 8  
11"

4 DRAWERS

N5PADG-3003L3	30" x 27" x 32"	2 4
N5PAEG-3003L3	36" x 27" x 32"	4 8

## 40" HIGH (W x D x H)



Width  
30" 36"  
3" 1 5  
3" 1 5  
3" 1 5  
4" 3 7  
4" 3 7  
7" 4 8  
7" 4 8

8 DRAWERS

N5PADG-3801L3	30" x 27" x 40"	1 3 4
N5PAEG-3801L3	36" x 27" x 40"	5 7 8



Width  
30" 36"  
3" 1 5  
3" 1 5  
4" 3 7  
4" 3 7  
7" 4 8  
10"

7 DRAWERS

N5PADG-3802L3	30" x 27" x 40"	1 3 4
N5PAEG-3802L3	36" x 27" x 40"	5 7 8



Width  
30" 36"  
3" 1 5  
4" 3 7  
7" 4 8  
10"  
10"

5 DRAWERS

N5PADG-3803L3	30" x 27" x 40"	1 3 4
N5PAEG-3803L3	36" x 27" x 40"	5 7 8

## 60" HIGH (W x D x H)



Width  
30" 36"  
4" 1 5  
3" 1 5  
4" 1 5  
4" 3 7  
4" 3 7  
4" 3 7  
4" 3 7  
7" 4 8  
7" 4 8  
7" 4 8  
7" 4 8

11 DRAWERS

N5PADG-5801L3	30" x 27" x 60"	1 3 4
N5PAEG-5801L3	36" x 27" x 60"	5 7 8

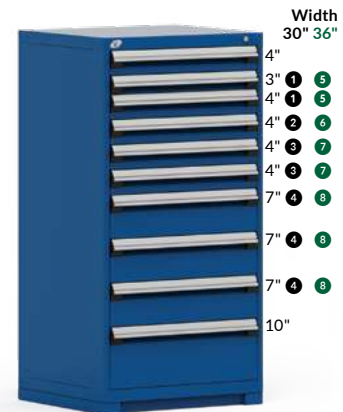

Width  
30" 36"  
4" 1 5  
4" 1 5  
4" 2 6  
4" 3 7  
4" 3 7  
7" 4 8  
7" 4 8  
7" 4 8  
10"

10 DRAWERS

N5PADG-5802L3	30" x 27" x 60"	1 2 3 4
N5PAEG-5802L3	36" x 27" x 60"	5 6 7 8

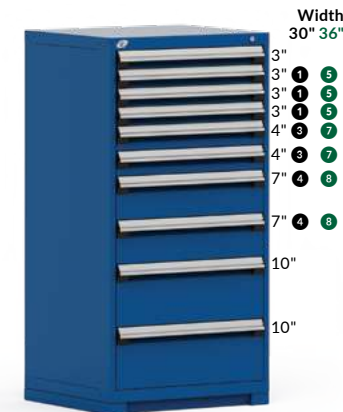

Width  
30" 36"  
3" 1 5  
3" 1 5  
3" 1 5  
4" 3 7  
4" 3 7  
7" 4 8  
7" 4 8  
10"  
10"

10 DRAWERS

N5PADG-5803L3	30" x 27" x 60"	1 3 4
N5PAEG-5803L3	36" x 27" x 60"	5 7 8

# PRECONFIGURED MODELS



The drawer interior layouts included in the preconfigured cabinet models are labeled 1 to 8 and can be found on [pages 283-284](#).

## 37 1/2" HIGH (W x D x H)



Width  
30" 36"

4" 1 5  
4" 3 7  
7" 4 8  
7" 4 8

### 5 DRAWERS

N5PBDG-3001L3A	30" x 27" x 37 1/2"	1 3 4
N5PBEG-3001L3A	36" x 27" x 37 1/2"	5 7 8



Width  
30" 36"

4" 1 5  
4" 3 7  
7" 4 8  
11"

### 4 DRAWERS

N5PBDG-3002L3A	30" x 27" x 37 1/2"	1 3 4
N5PBEG-3002L3A	36" x 27" x 37 1/2"	5 7 8



Width  
30" 36"

4" 2 6  
4" 3 7  
7" 4 8  
11"

### 4 DRAWERS

N5PBDG-3003L3A	30" x 27" x 37 1/2"	2 4
N5PBEG-3003L3A	36" x 27" x 37 1/2"	6 8

## 41 1/2" HIGH (W x D x H)



Width  
30" 36"

4" 1 5  
4" 2 6  
4" 3 7  
4" 5 7  
7" 4 8  
7" 4 8

### 6 DRAWERS

N5PBDG-3401L3A	30" x 27" x 41 1/2"	1 3 4
N5PBEG-3401L3A	36" x 27" x 41 1/2"	5 6 7 8



Width  
30" 36"

3" 1 5  
3" 3 6  
3" 4 7  
4" 5 8  
7" 4 8  
10"

### 6 DRAWERS

N5PBDG-3402L3A	30" x 27" x 41 1/2"	1 3 4
N5PBEG-3402L3A	36" x 27" x 41 1/2"	5 7 8



Width  
30" 36"

3" 1 5  
3" 3 7  
4" 5 8  
10"

### 5 DRAWERS

N5PBDG-3403L3A	30" x 27" x 41 1/2"	1 3
N5PBEG-3403L3A	36" x 27" x 41 1/2"	5 7





The drawer interior layouts included in the preconfigured cabinet models on pages 281-282 are labeled 1 to 8.

You can choose other drawer interiors, including tool racks, see pages 283-284.

**MODEL ORDERS MUST BE COMPLETED AS FOLLOWS :**

00 for subdividing only  
51 for a subdivided drawer

Drawer height in inches

e.g., R\_\_EG-A042604

**Locking mechanism :**

L3: Lock on the drawer

A: Integrated Lock-In Mechanism (prevents the drawer from opening on its own when cabinet is moved)

L3A: Lock on the drawer and Integrated Lock-In Mechanism (prevents the drawer from opening on its own when cabinet is moved)

e.g., R51EG-TW1604A  
For a 36"W x 27"D subdivided drawer and Integrated Lock-In Mechanism.

**IMPORTANT**

1.64"W storage trays can only store type A tools.

2.64"W storage trays can store type A and type B tools.

**IMPORTANT**

Models with partitions and dividers are designed to store disassembled tools. We do not recommend storing assembled tools in them.

**IMPORTANT**

The quantities shown in the models with storage trays or with partitions and dividers are for illustrative purposes only. The number of punches and dies stored will vary based on the client's specific situation.

## 30"W x 27"D DRAWERS

### PUNCH AND DIE RACKS



N00DG-P0100  
N51DG-P0110\_\_  
N51DG-P0111\_\_

Tools	Punch	Dies
B	4	12
C	4	8
D	2	4



N00DG-P0200  
N51DG-P0210\_\_  
N51DG-P0211\_\_

Tools	Punch	Dies
C	12	24



N00DG-P0300  
N51DG-P0310\_\_  
N51DG-P0311\_\_

Tools	Punch	Dies
C	4	8
D	2	4
E	2	4

### RACKS AND DIVIDERS

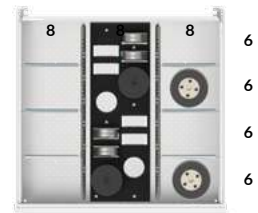

N00DG-P0400  
N51DG-P0410\_\_  
N51DG-P0411\_\_

Tools	Punch	Dies
C	4	8
C D E	8	

### STORAGE TRAYS

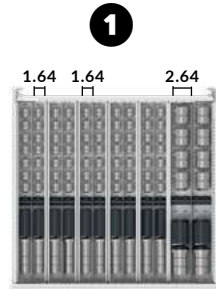

R\_\_DG-TW1203\_\_  
R\_\_DG-TW1204\_\_

Tools	Punch	Dies
A	12	60

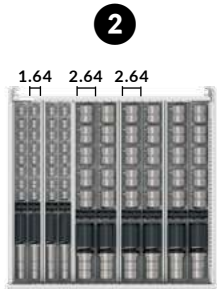

R\_\_DG-TW1004\_\_

Tools	Punch	Dies
A	4	20
B	6	18

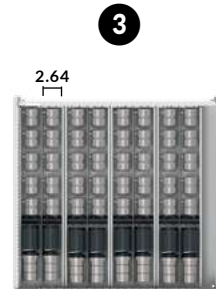

R\_\_DG-TW0804\_\_

Tools	Punch	Dies
B	8	24

### PARTITIONS AND DIVIDERS

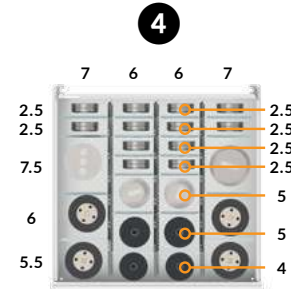

N\_\_DG-A032007\_\_

Tools	Punch	Dies
C D E	12	12

# PRECONFIGURED MODELS / COMPONENTS



## 36"W x 27"D DRAWERS

### PUNCH AND DIE RACKS

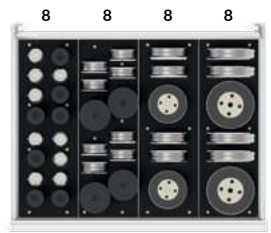

N00EG-P0100  
N51EG-P0110\_\_  
N51EG-P0111\_\_

Tools	Punch	Dies
B	4	12
C	4	8
D	2	4
E	2	4



N00EG-P0200  
N51EG-P0210\_\_  
N51EG-P0211\_\_

Tools	Punch	Dies
C	12	24
D	2	4



N00EG-P0300  
N51EG-P0310\_\_  
N51EG-P0311\_\_

Tools	Punch	Dies
C	8	16
D	2	4
E	2	4

### RACKS AND DIVIDERS

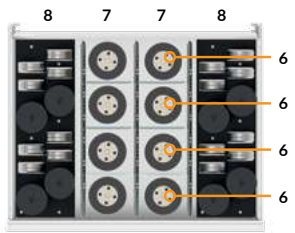

N00EG-P0400  
N51EG-P0410\_\_  
N51EG-P0411\_\_

Tools	Punch	Dies
C	8	16
C D E	8	

### STORAGE TRAYS

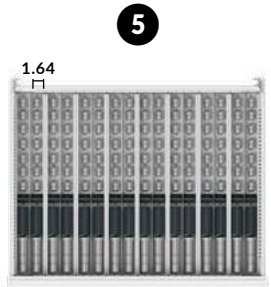

R\_\_EG-TW1603\_\_  
R\_\_EG-TW1604\_\_

Tools	Punch	Dies
A	16	80

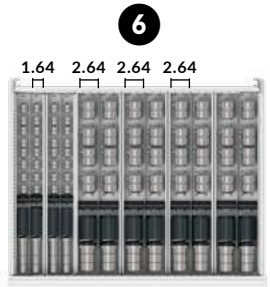

R\_\_EG-TW1204\_\_

Tools	Punch	Dies
A	4	20
B	8	24



R\_\_EG-TW1004\_\_

Tools	Punch	Dies
B	10	30

### PARTITIONS AND DIVIDERS

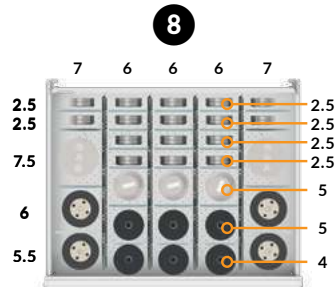

N\_\_EG-A042607\_\_

Tools	Punch	Dies
C D E	14	16

## PUNCHING TOOL RACKS

These tools racks are made of galvanized steel and protected with a 1/4" thick durable PVC plate. Punches are supported by their shoulders and do not rest directly on the drawer bottom. The racks spread the load and prevent buckling of the drawer bottom.

- Trays A and B store 3 dies (lying flat) for every punch
- Trays C, D and E store 2 dies (upright) for every punch
- Versions C, D and E include a second level to stabilize the position of the tools
- Recommended for maximum 36"W housings
- Designed to be installed in a 10"H or 11"H (9" usable height) drawer, 27" deep.
- Width: 8"



NC83-082701 8" x 27" x 9"

Tools	Punch	Dies
A	12	36



NC83-082702 8" x 27" x 9"

Tools	Punch	Dies
B	4	12



NC83-082703 8" x 27" x 9"

Tools	Punch	Dies
C	4	8



NC83-082704 8" x 27" x 9"

Tools	Punch	Dies
D	2	4



NC83-082705 8" x 27" x 9"

Tools	Punch	Dies
E	2	4



## BENDING TOOL STORAGE SYSTEM

Rousseau's bending tool storage system has been designed to provide maximum protection for your punches and dies while offering optimal and ergonomic storage.

Our storage solutions have been engineered for the tools you use, and they take into account the management methods available for storing and transporting them within your company. Our range of solutions are compatible with multiple tool styles: American, European, Wilson WT, Wila NS, Trumpf and more.

Whether you use a system where the tools are stored in a central store then allocated based on the daily production schedule, or each press brake has a toolbox containing the punches and dies needed for specific tasks, we are sure you will find a Rousseau storage solution that meets your needs.

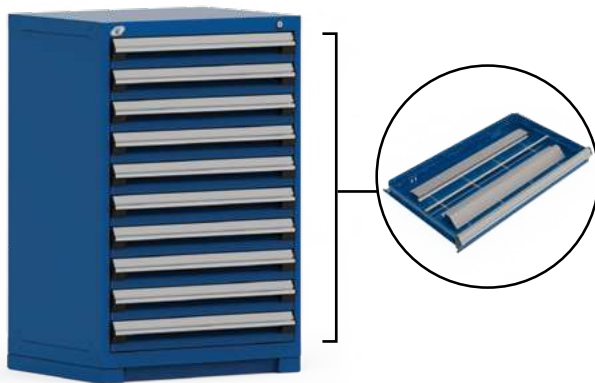



### STATIONARY CABINETS

The tools used for bending sheet metal are heavy and come in many different shapes. To store them regardless of their shape, size or weight, we offer a reinforced RF62 tool drawer fitted with a RG07

structural partition. Extra structural partitions can be added as needed to increase the number of subdivisions inside the drawer. [See page 291.](#)



W x D	DRAWER HEIGHT AND LAYOUT																							
	36"								40"															
	RF62		RF31		RF62		RF31		RF62		RF31		RF62		RF31									
	H	QTY	H	QTY	H	QTY	H	QTY	H	QTY	H	QTY	H	QTY	H	QTY								
	4"	5	5"	2	-	-	4"	5	-	-	10"	1	4"	6	5"	2	-	-	4"	6	-	-	10"	1
30" x 24"	N5BADE-3401L3				N5BADE-3402L3				N5BADE-3801L3				N5BADE-3802L3											
30" x 27"	N5BADG-3401L3				N5BADG-3402L3				N5BADG-3801L3				N5BADG-3802L3											
36" x 24"	N5BAEE-3401L3				N5BAEE-3402L3				N5BAEE-3801L3				N5BAEE-3802L3											
36" x 27"	N5BAEG-3401L3				N5BAEG-3402L3				N5BAEG-3801L3				N5BAEG-3802L3											
42" x 24"	N5BAGE-3401L3				N5BAGE-3402L3				N5BAGE-3801L3				N5BAGE-3802L3											
42" x 27"	N5BAGG-3401L3				N5BAGG-3402L3				N5BAGG-3801L3				N5BAGG-3802L3											
48" x 24"	N5BAHE-3401L3				N5BAHE-3402L3				N5BAHE-3801L3				N5BAHE-3802L3											
48" x 27"	N5BAHG-3401L3				N5BAHG-3402L3				N5BAHG-3801L3				N5BAHG-3802L3											
54" x 24"	N5BAJE-3401L3				N5BAJE-3402L3				N5BAJE-3801L3				N5BAJE-3802L3											
54" x 27"	N5BAJG-3401L3				N5BAJG-3402L3				N5BAJG-3801L3				N5BAJG-3802L3											



W x D	DRAWER HEIGHT AND LAYOUT																					
	46"								60"													
	RF62		RF31		RF62		RF31		RF62		RF31		RF62		RF31							
	H	QTY	H	QTY	H	QTY	H	QTY	H	QTY	H	QTY	H	QTY	H	QTY						
	4"	10	-	-	4"	8	-	-	8"	1	4"	11	5"	2	-	-	4"	11	-	-	10"	1
30" x 24"	N5BADE-4401L3				N5BADE-4402L3				N5BADE-5801L3				N5BADE-5802L3									
30" x 27"	N5BADG-4401L3				N5BADG-4402L3				N5BADG-5801L3				N5BADG-5802L3									
36" x 24"	N5BAEE-4401L3				N5BAEE-4402L3				N5BAEE-5801L3				N5BAEE-5802L3									
36" x 27"	N5BAEG-4401L3				N5BAEG-4402L3				N5BAEG-5801L3				N5BAEG-5802L3									
42" x 24"	N5BAGE-4401L3				N5BAGE-4402L3				N5BAGE-5801L3				N5BAGE-5802L3									
42" x 27"	N5BAGG-4401L3				N5BAGG-4402L3				N5BAGG-5801L3				N5BAGG-5802L3									
48" x 24"	N5BAHE-4401L3				N5BAHE-4402L3				N5BAHE-5801L3				N5BAHE-5802L3									
48" x 27"	N5BAHG-4401L3				N5BAHG-4402L3				N5BAHG-5801L3				N5BAHG-5802L3									
54" x 24"	N5BAJE-4401L3				N5BAJE-4402L3				N5BAJE-5801L3				N5BAJE-5802L3									
54" x 27"	N5BAJG-4401L3				N5BAJG-4402L3				N5BAJG-5801L3				N5BAJG-5802L3									





## MOBILE CABINETS



W x D		DRAWER HEIGHT AND LAYOUT																							
		37½"								41½"															
		RF62				RF31				RF62				RF31				RF62				RF31			
		H	QTY	H	QTY	H	QTY	H	QTY	H	QTY	H	QTY	H	QTY	H	QTY	H	QTY	H	QTY	H	QTY	H	QTY
30" x 24"	N5BBDE-3001L3A				N5BBDE-3002L3A				N5BBDE-3401L3A				N5BBDE-3402L3A												
30" x 27"	N5BBDG-3001L3A				N5BBDG-3002L3A				N5BBDG-3401L3A				N5BBDG-3402L3A												
36" x 24"	N5BBEE-3001L3A				N5BBEE-3002L3A				N5BBEE-3401L3A				N5BBEE-3402L3A												
36" x 27"	N5BBEG-3001L3A				N5BBEG-3002L3A				N5BBEG-3401L3A				N5BBEG-3402L3A												
42" x 24"	N5BBGE-3001L3A				N5BBGE-3002L3A				N5BBGE-3401L3A				N5BBGE-3402L3A												
42" x 27"	N5BBGG-3001L3A				N5BBGG-3002L3A				N5BBGG-3401L3A				N5BBGG-3402L3A												
48" x 24"	N5BBHE-3001L3A				N5BBHE-3002L3A				N5BBHE-3401L3A				N5BBHE-3402L3A												
48" x 27"	N5BBHG-3001L3A				N5BBHG-3002L3A				N5BBHG-3401L3A				N5BBHG-3402L3A												
54" x 24"	N5BBJE-3001L3A				N5BBJE-3002L3A				N5BBJE-3401L3A				N5BBJE-3402L3A												
54" x 27"	N5BBJG-3001L3A				N5BBJG-3002L3A				N5BBJG-3401L3A				N5BBJG-3402L3A												





## CHANGE CART

Change carts are used for a specific purpose. They are the link between the central store and tool cabinets, which are located next to press brakes, so the cabinets can be filled and emptied on a daily basis.

They have a wider wheelbase at the front of the cart to ensure perfect stability. The cart top has an adjustable tool tray and laminated hardwood top for easy tool preparation.

- Preconfigured cart models have 6" casters, including two rigid and two swivel casters with total-lock brakes, as well as an integrated lock-in mechanism (A)
- All cabinets are fitted with a True One-Drawer-at-a-Time System
- 4 RF62 drawers (4"H) with RG07 partition
- 1 roll-out shelf (6"H)
- All cabinets include a standard cabinet lock
- To add an L50 electronic lock, [see page 45](#)
- Two versions of adjustable tool tray:
  - o 02 (1.0" / 10): recommended for American-type tools. Hollow depth: 1.030"
  - o 01 (1.5" / 15): recommended for European, Wilson WT, Wila NS, Trumpf type tools. Hollow depth: 1.468"

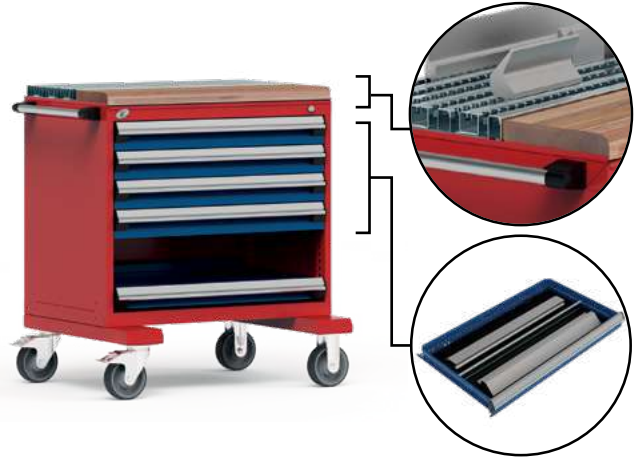

W×D×H	TRAY	PRODUCT NO.
36" 24" 41 1/4"	15	N5CBEE-3001L3A
	10	N5CBEE-3002L3A
42" 24" 41 1/4"	15	N5CBGE-3001L3A
	10	N5CBGE-3002L3A

**NOTES:** Refer to technical guide N55 to determine the tray best suited to your tool type.  
 The usable height of each drawer is 1" inch less than its nominal height. Refer to the usable width to determine the usable dimensions you will have for your tools.  
 Leave sufficient space for gripping your tools. We recommend 1 1/2" on either side of the tool.



Always distribute the load evenly to prevent the change cart from tipping.





## VTZ CABINETS FOR BENDING TOOLS

With VTZ (Vertical Tool Zone) Vertical Storage, you can store many different tools in a relatively small floor area.

The shelves can be adjusted vertically in 3/4" increments c/c to accommodate the height of your tools. They can also support a load of 250lb. Each of the drawers features a floor rolling system that supports a 1,000lb. load in total.

For tool storage, the drawers include universal shelves (flat) and/or adjustable shelves (upright). Extra shelves can be added as needed.

- Two versions of adjustable tool tray:
  - o 1.0": recommended for American-type tools. Hollow depth: 1.030"
  - o 1.5": recommended for European, Wilson WT, Wila NS, Trumpf type tools. Hollow depth: 1.468"
- To order a drawer lock, add L3 to the product number
- To order a drawer locking system with latch, add LC to the product number



NO. OF DRAWERS	W	D	H	TRAY	LINEAR FEET	PRODUCT NO.
3	23 1/2"	44"	62"	Universal	40.25'	NCB-AH620001__
			62"	1,0"	40.25'	NCB-AH621001__
			62"	1,5"	40.25'	NCB-AH621501__
		48"	62"	Without	40.25'	NCV-AH629901__
			62"	Universal	44.25'	NCB-AI620001__
			62"	1,0"	44.25'	NCB-AI621001__
4	30 1/2"	44"	62"	1,5"	44.25'	NCB-AI621501__
			62"	Without	44.25'	NCV-AI629901__
			62"	Universal	53'	NCB-DH620001__
		48"	62"	1,0"	53'	NCB-DH621001__
			62"	1,5"	53'	NCB-DH621501__
			62"	Sans	53'	NCV-DH629901__
5	37 1/2"	44"	62"	Universal	59'	NCB-DI620001__
			62"	1,0"	59'	NCB-DI621001__
			62"	1,5"	59'	NCB-DI621501__
		48"	62"	Without	59'	NCV-DI629901__
			62"	Universal	67'	NCB-GH620001__
			62"	1,0"	67'	NCB-GH621001__
6	44 1/2"	44"	62"	1,5"	67'	NCB-GH621501__
			62"	Without	67'	NCV-GH629901__
			62"	Universal	74'	NCB-GI620001__
		48"	62"	1,0"	74'	NCB-GI621001__
			62"	1,5"	74'	NCB-GI621501__
			62"	Without	74'	NCV-GI629901__
6	44 1/2"	44"	62"	Universal	80.5'	NCB-JH620001__
			62"	1,0"	80.5'	NCB-JH621001__
			62"	1,5"	80.5'	NCB-JH621501__
		48"	62"	Without	80.5'	NCV-JH629901__
			62"	Universal	88.5'	NCB-JI620001__
			62"	1,0"	88.5'	NCB-JI621001__
			62"	1,5"	88.5'	NCB-JI621501__
			62"	Without	88.5'	NCV-JI629901__



L3 Lock



LC Latch

NOTES: The width of your tools determines the depth of the VTZ cabinet to choose. Leave sufficient space for gripping your tools. We recommend 1 1/2" on either side of the tool.



NCB-GI621001L3



# COMPONENTS



## BENDING TOOL SHELVES AND TRAYS

### UNIVERSAL SHELF FOR VTZ CABINETS

- For storing punches and dies flat
- 4 3/16" W surface in the center for storing tools
- Can be used to store a variety of items

DEPTH	USABLE DEPTH	PRODUCT NO.
44"	40 1/4"	NC62-0704400
48"	44 1/4"	NC62-0704800

### ADJUSTABLE SHELVES FOR VTZ CABINETS

- For storing punches and dies upright
- Can be adjusted to accommodate most tool tangs
- Includes a fixed central part and two adjustable parts on the sides. The position of the adjustable parts can be adjusted along the width (0.500" to 0.787") based on the tools stored by loosening the screws
- Includes perforations in the center where the tool's middle section can be clipped in if needed
- Two versions available:
  - o 10 (1.0"): recommended for American-type tools. Hollow depth: 1.030"
  - o 15 (1.5"): recommended for European, Wilson WT, Wila NS, Trumpf type tools. Hollow depth: 1.468"

DEPTH	USABLE DEPTH	TRAY	PRODUCT NO.
44"	40 1/4"	10	NC62-0704410
		15	NC62-0704415
48"	44 1/4"	10	NC62-0704810
		15	NC62-0704815

NOTE: Refer to technical guide N55 to determine the shelf best suited to your tool type.

#### Shelves for VTZ cabinets

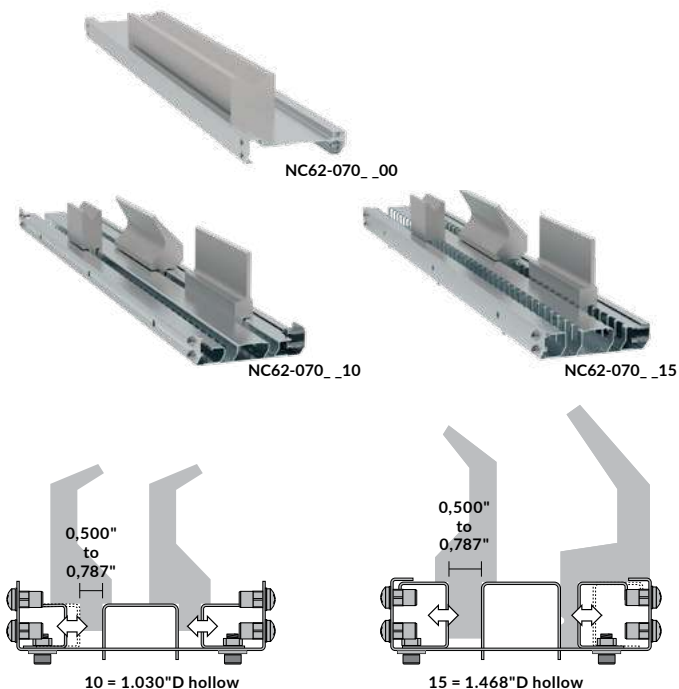

### ADJUSTABLE TRAY FOR R DRAWERS

- Sits in the bottom of Rousseau heavy-duty drawers (RF31 and RF62).
- Multiple widths and depths are available so trays can be added to an existing Rousseau cabinet

NOTES: Refer to technical guide N55 to determine the tray best suited to your tool type. The usable height of each drawer is 1" inch less than its nominal height. Refer to the usable width to determine the usable dimensions you will have for your tools. Leave sufficient space for gripping your tools. We recommend 1 1/2" on either side of the tool.

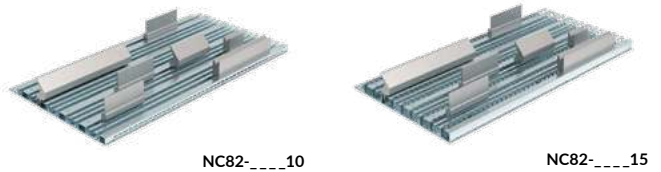

#### Trays for R drawers

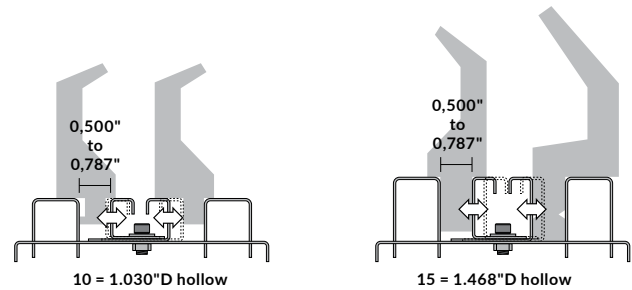

WIDTH	USABLE WIDTH	DEPTH	NO. OF HOLLOW	PRODUCT NO.
30"	25 1/2"	21"	6	NC82-302110
			6	NC82-302115
		27"	9	NC82-302710
			9	NC82-302715
36"	31 1/2"	21"	6	NC82-362110
			6	NC82-362115
		24"	8	NC82-362410
			8	NC82-362415
		27"	9	NC82-362710
			9	NC82-362715
42"	37 1/2"	24"	8	NC82-422410
			8	NC82-422415
		27"	9	NC82-422710
			9	NC82-422715
48"	43 1/2"	24"	8	NC82-482410
			8	NC82-482415
		27"	9	NC82-482710
			9	NC82-482715
		24"	8	NC82-542410
			8	NC82-542415
54"	49 1/2"	27"	9	NC82-542710
			9	NC82-542715



## DRAWER COMPONENTS

### HEAVY-DUTY TOOL DRAWER

RF62

- Compatible with RG07 heavy-duty partitions
- 400lb. load capacity, 100% extension
- Heavy-duty construction
- Easy to install
- Maximizes use of space and limits wasted storage space
- Drawer heights available: 3", 4" and 5".
- To order: Specify the desired height (03", 04" or 05") and the lock-in mechanism if required, e.g., RF62-302403A

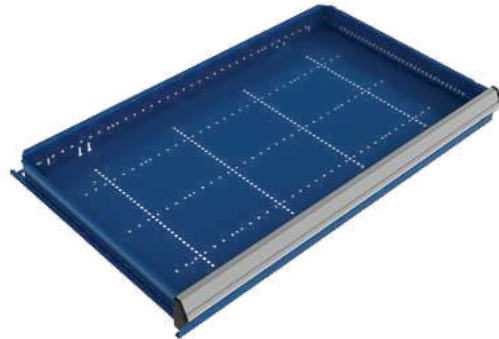

WIDTH	DEPTH	PRODUCT NO.
30"	24"	RF62-3024_
	27"	RF62-3027_
36"	24"	RF62-3624_
	27"	RF62-3627_
42"	24"	RF62-4224_
	27"	RF62-4227_
48"	24"	RF62-4824_
	27"	RF62-4827_
54"	24"	RF62-5424_
	27"	RF62-5427_

### HEAVY-DUTY PARTITION FOR RF62 DRAWER

RG07

- For storing punches and dies flat
- Heavy-duty partitions (RG07) are used to separate tools and provide reinforcement at the bottom of the drawer to prevent it from buckling under a concentrated load
- Specially designed for tool drawers (RF62)
- Screws in from underneath and to one end of the drawer



WIDTH	USABLE WIDTH	PRODUCT NO.
30"	25½"	RG07-3003
36"	31½"	RG07-3603
42"	37½"	RG07-4203
48"	43½"	RG07-4803
54"	49½"	RG07-5403

### RUBBER MAT

RG58

- ½" black neoprene mat for RF31 and RF62 drawers for protecting tools and items stored at the bottom of the drawer
- Installs between partitions (RG07)
- Installs underneath bending tool trays (NC82)

WIDTH	DEPTH	PRODUCT NO.
30"	24"	RG58-3024
	27"	RG58-3027
36"	24"	RG58-3624
	27"	RG58-3627
42"	24"	RG58-4224
	27"	RG58-4227
48"	24"	RG58-4824
	27"	RG58-4827
54"	24"	RG58-5424
	27"	RG58-5427

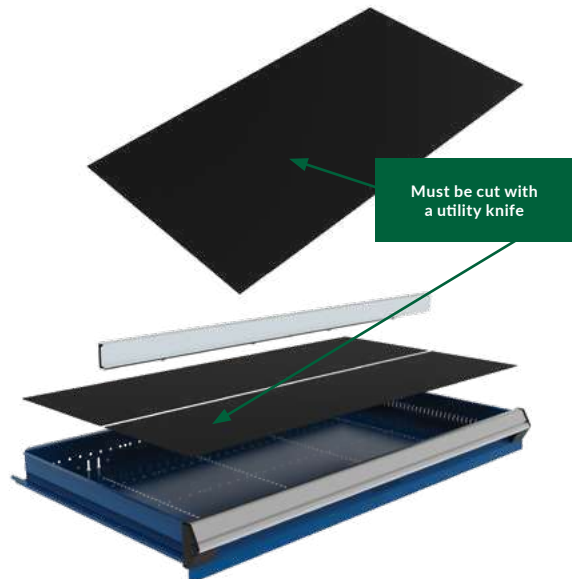

# CABINET FOR TWO USERS

## DISTINCTIVE FEATURES

- The two-user option lets you create separate access for individual users within the same cabinet
- Designed for Multi-Drawer Cabinets and R2V Vertical Drawer Cabinets
- Separate locks so each employee can lock their own bank of drawers
- Available with key locks, safety hasps or electronic locks
- Widths available: 48" and 60"



L3 Lock



LP Lock



L50 Lock



### INDIVIDUAL LOCK FOR USER 1 AND 2

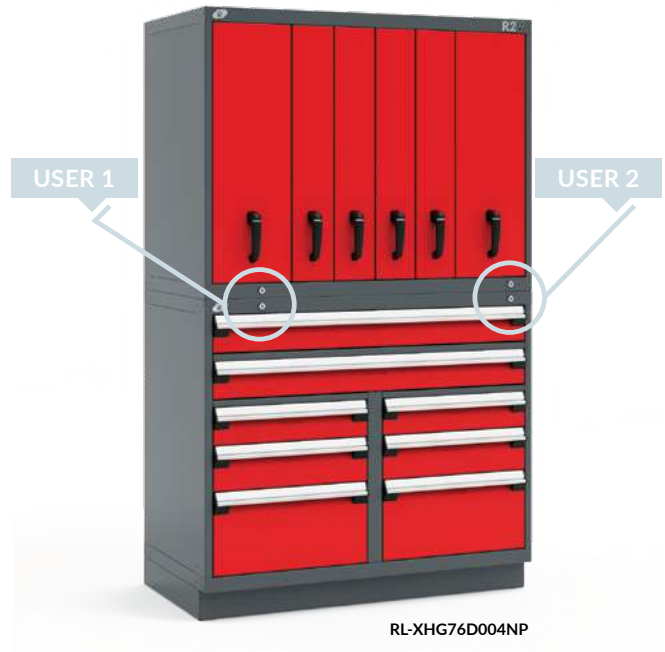

### CHOOSE A CABINET FOR TWO USERS WHEN:

- Multiple shifts work with the same workstations
- Floor space is limited and two people need to use the same cabinets

BEFORE  
TOTAL  
WIDTH: 18'



AFTER  
TOTAL  
WIDTH: 14'



## MAIN COMPONENTS

### MULTI-DRAWER CABINET



Multi-Drawer Housing for Two Users (RA34, RA45+RA46)



Heavy-Duty Drawer (RF31)



Security Panels (RF91/RF92)

### R2V VERTICAL DRAWER CABINET



R2V Housing for Two Users (RL29)



Vertical Drawer (RL31)



Security Panel (RL91)

## PRECONFIGURED MODELS



PRODUCT NO.	W × D × H
R6KHG-3802S	48" × 27" × 42"



PRODUCT NO.	W × D × H
RL-XHG76D002NS	48" × 27" × 76"

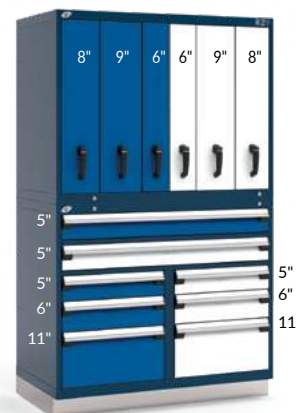

PRODUCT NO.	W × D × H
RL-XHG76D004NS	48" × 27" × 76"

NOTE: The use of the blue and white colors is to simulate user 1 and user 2 and is for illustrative purposes only.

# KEY TYPES - L3

## FEATURES AND BENEFITS

To ensure your work tools remain safe and secure, it's important to be able to lock your storage solutions when required. We have several key management options for different scenarios. For example, for ease of use, you may want the same key to open any unit; or perhaps, for extra security, you require different

keys for each unit; or maybe you want different access levels based on seniority. For our L3 lock and key system we have three management types: identical keys (KA), different keys (KD) and a master key system (MK).



**FOR ALL PRODUCTS AND COMPONENTS WITH LOCKS, SPECIFY THE TYPE OF KEY REQUIRED: KA, KD OR MK.**

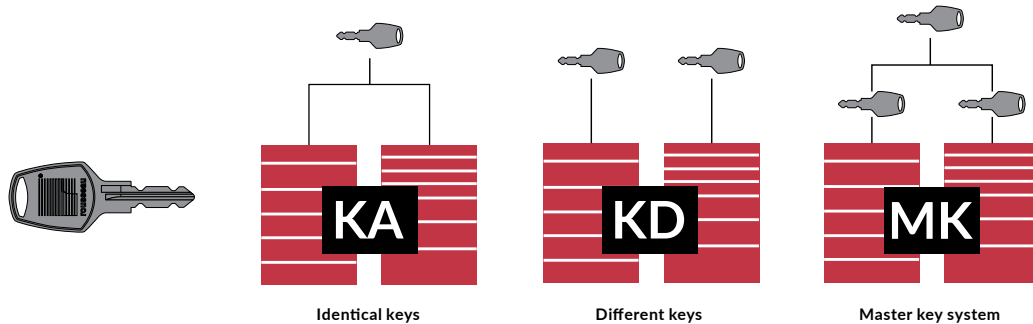

**YOU MUST SPECIFY THE TYPE OF KEY REQUIRED FOR THE PRODUCTS BELOW**

### PRECONFIGURED MODELS

- R Heavy-Duty Stationary Cabinet (N5B, N5P and R5A)
- R Heavy-Duty Mobile Cabinet (N5B, N5C, R5B and R5D)
- Stacking Cabinet (R5H)
- Sink Cabinet (R5T)
- L Compact Stationary Cabinet (L3A)
- L Compact Mobile Cabinet (L3B)
- Hanging Side Cabinet (R5Q)
- R Multi-Drawer Stationary Cabinet (R5K)
- R Multi-Drawer Mobile Cabinet (R5G)
- Drawer Unit (LD75, LD77 and RD77)
- TekZone Hutch (TZ)
- Corner Workstation (RS)
- Wall-Mounted Computer Cabinet and Housing (R5M)
- Computer Cabinet (R5J)
- MultiTek Cart (RV)
- R2V Cabinet (RL)
- VTZ Cabinet (NCB and NCV)

### COMPONENTS AND ACCESSORIES

- Integrated Sliding Door or with Frame, Solid or Polycarbonate (RB50, RB51, RB55, RB56, WS60 and WS61)
- Single Integrated Door or with Frame, Solid or Polycarbonate (RB61, RB62, RD12, RD13 and RD51)
- Double Integrated Door or with Frame, Solid or Polycarbonate (RB66, RB67, RB75, RB76, RD17, RD18, SH41, SH43, SH91 and SH93)
- Door for L Cabinet (LB30)
- Flipper Door (RD20 and SH85)
- Vertical Security Bar (RB10, RE80 and LB10)
- Compact Drawer (LF31)
- Cabinet Locking System (L3)
- Heavy-Duty Modular Drawer and Roll-Out Shelf (RF31, RF32, RF35, RF36, RF40, RF41, RF44 and RF45)
- Heavy-Duty Cabinet and Stacking Cabinet Housing (RA30)
- Storage Cabinet (WM75)
- Sloped Top (RC30)
- L Compact Cabinet (LA30)
- R2V Vertical Housing (RL30)
- R2V Vertical Housing for Two Users (RL29)
- Multi-drawer Housing for Two Users (RA34)
- VTZ Vertical Housing (NC55)

NOTES: Please contact your customer service representative for questions about the different key types. They will be happy to assist you. All products with a lock need to have a key code, the list above is for reference purposes only.



## L50 ELECTRONIC LOCK FOR CABINET WITH DRAWERS

- Electronically locks all drawers in the cabinet at the same time
- No key required
- Up to 20 different users can be programmed
- 4- to 8-digit access codes
- Simplifies access management to drawers

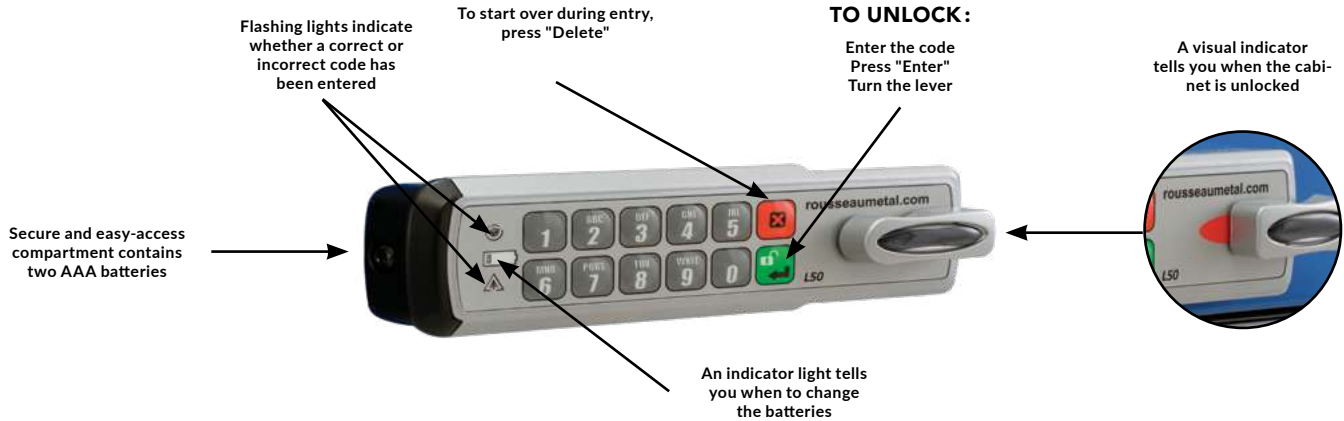

## VARIOUS WAYS TO MANAGE ACCESS

### "OWNER" USER (UNIQUE CODE)

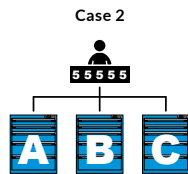
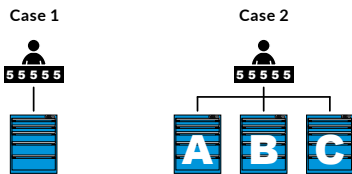

### SUPERVISOR (UNIQUE CODE) WITH USERS (SAME CODE)

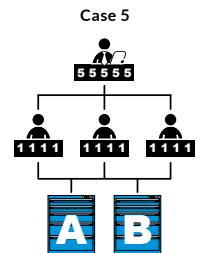
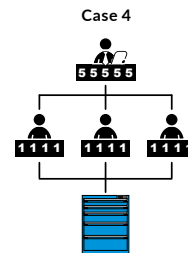

### SUPERVISOR (UNIQUE CODE) WITH USERS (DIFFERENT CODES)

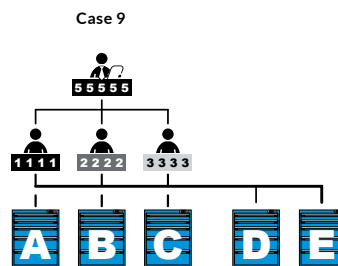
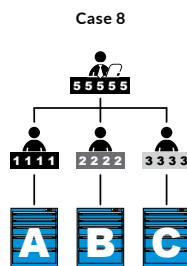
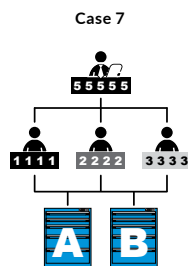
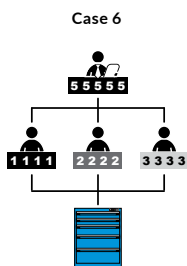

## HOW TO ORDER

### To order the complete mechanism with a drawer cabinet, order:

- RB00-DD HHL50 for an R cabinet (RA30)
- RB01-WW DD HHL50 for a multi-drawer cabinet (RA35), contact Customer Service
- LB00-DD HHL50 for an L cabinet (LA30)
- RB03-DD HHL50 for a multi-drawer cabinet for two users (RA34)

### To order as a replacement lock, order:

- HA48-L50 for an R cabinet with drawers or multi-drawer cabinet (RA30 / RA35)
- HA52-L50 for an L cabinet with drawers (LA30)
- HA48-L50 (x2) for a multi-drawer cabinet for two users (RA34)
- HA52-L50 for an RL cabinet with vertical drawers (RL30)

NOTE: The L50 Electronic Lock interferes with RB92 front handles. Please contact Customer Service for more details.

# KEY TYPES - L50

## L50 ELECTRONIC LOCK FOR DOORS

- Electronically locks doors of Rousseau products
- No key required
- Up to 20 different users can be programmed
- 4-8 digit access codes
- Compatible with L, R and SH swing doors, single or double, solid or polycarbonate, with or without frame (LB30, RB61/RB62, RB67/RB66, RD12/RD13, RD17/RD18, RB75/RB76, SH41/SH43 and SH91/SH93)
- Compatible with RD20, SH85 and WM76 flipper doors and RH06 pull-down doors
- Not compatible with sliding doors (RB50/RB51, RB55/RB56 and WS60/WS61)



## VARIOUS WAYS TO MANAGE ACCESS

### "OWNER" USER (UNIQUE CODE)

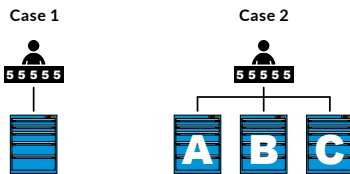

### SUPERVISOR (UNIQUE CODE) WITH USERS (SAME CODE)

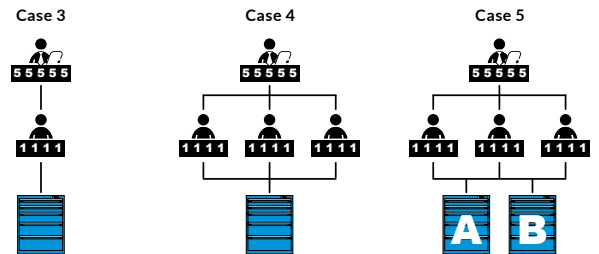

### SUPERVISOR (UNIQUE CODE) WITH USERS (DIFFERENT CODES)

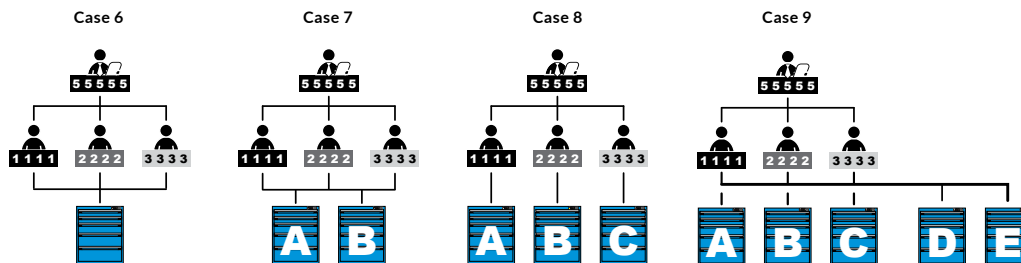

### HOW TO ORDER

#### To order an L50 lock for an existing door:

- RY50-L50 for an RB61 and RB62 door
- RY51-L50 for an RB66 and RB67 door
- RY52-L50 for an RB75 and RB76 door
- RY56-L50 for an RD12 and RD13 door
- RY57-L50 for an RD17 and RD18 door
- SY50-L50 for an SH door manufactured after March 2019
- RY63-L50 for an RH06 door manufactured before October 2018
- HA72-L50 for an RH06 door manufactured after October 2018

NOTE: Not compatible with SH doors manufactured before March 2019.



## ROUSSEAU'S COMMITMENT TO THE ENVIRONMENT

Rousseau is constantly seeking to minimize its environmental footprint. We have taken various measures over the years to meet this goal, such as using paint that produces no volatile organic compounds (VOCs), and recycling cardboard and scrap metal. These initiatives help users of Rousseau products to qualify for LEED® certification. By choosing Rousseau, you are choosing a responsible and environmentally conscious manufacturer.

### HERE'S WHY

#### USING POWDER PAINT

For several years now, Rousseau has been using powder paint instead of liquid paint for all products manufactured. This significantly reduces emissions of CO2 and eliminates several tons of hazardous materials. It is now the only type of paint used in the plant.

#### RECYCLING CARDBOARD AND SCRAP METAL

To do our part for the environment, Rousseau recycles all scrap steel and aluminum. It is sent to a processing facility and melted down for use elsewhere. Boxes and pallets are also sent out to be used for heating, among other uses.

Plastics are sent to a collection center.

#### OPTIMIZING VENTILATION SYSTEMS

Our ventilation systems have gradually been updated with automated controllers that reduce the amount of fresh air and heating needed.

#### REDUCING WATER CONSUMPTION

The plant has also reduced its water consumption by 90% thanks to an ingenious water cooling system.

#### USING PAPER SOURCED FROM RESPONSIBLY MANAGED FORESTS

As part of our commitment to sustainable development, we prioritize the use of paper from responsibly managed forests and other controlled sources.

Rousseau is confirming its status as an industry leader by implementing these environmentally conscious initiatives

## ROUSSEAU AND LEED®

LEED® (Leadership in Energy and Environmental Design) is an international green standard of certification created in 1998 by the USGBC (U.S. Green Building Council). Projects can obtain LEED® certification through a points-based system, which means the certified building or project excels in environmental compliance.

Rousseau can help customers obtain this certification because its environmentally-friendly processes can contribute toward earning LEED® points.

## ROUSSEAU PRODUCTS CONTRIBUTE TO THE FOLLOWING LEED CRITERIA

### SUSTAINABLE SITES CATEGORY

5.2 Reduced Site Disturbance: Development footprint

### MATERIALS & RESOURCES CATEGORY

2.1 Construction Waste Management: Divert 50% from landfill

2.2 Construction Waste Management: Divert 75% from landfill

3.1 Resource Reuse: 5%

3.2 Resource Reuse: 10%

4.1 Recycled Content: 7.5% CAN and 10% USA

4.2 Recycled Content: 15% CAN and 20% USA

5.1 Regional Materials: 10%

5.2 Regional Materials: 20%

### INDOOR ENVIRONMENTAL QUALITY CATEGORY

4.2 Low-Emitting Materials: Paints and coatings

4.4 Low-Emitting Materials: Composite wood and laminate adhesives

For more details about the solutions that Rousseau Metal Inc. has implemented to meet LEED criteria®, visit [rousseaumetal.com](http://rousseaumetal.com).

NOTES: For more details about the solutions that Rousseau Metal Inc. has implemented to meet LEED® criteria, visit [rousseaumetal.com](http://rousseaumetal.com).

This information was updated in June 2009. For more details, contact us

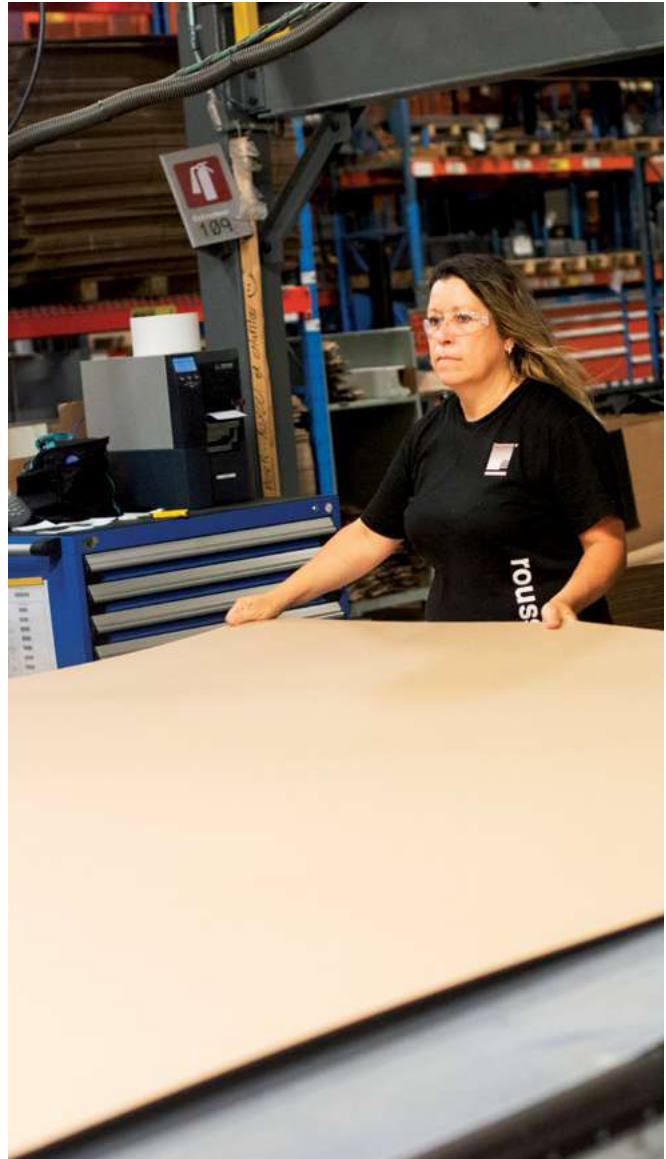

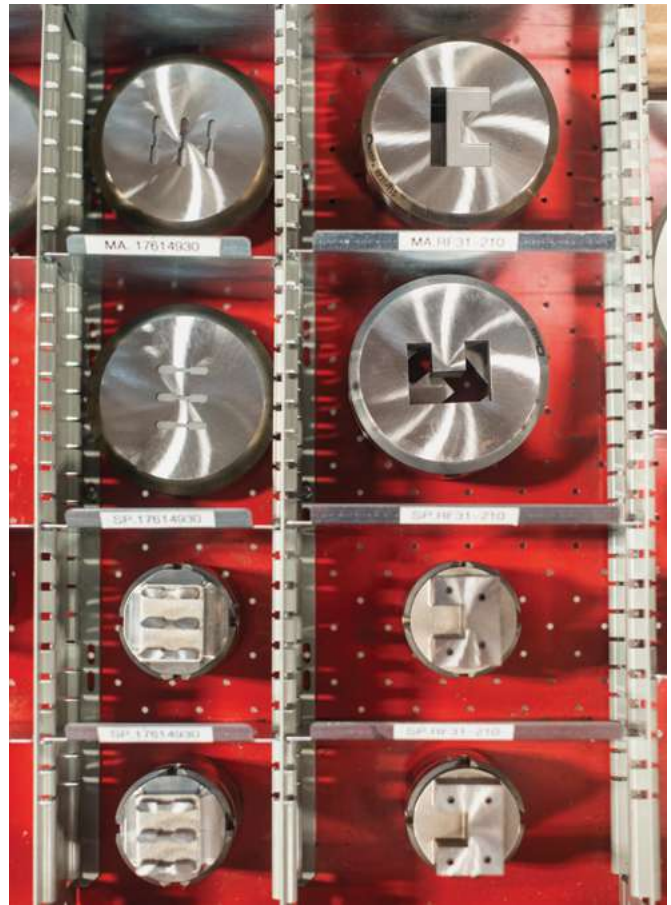

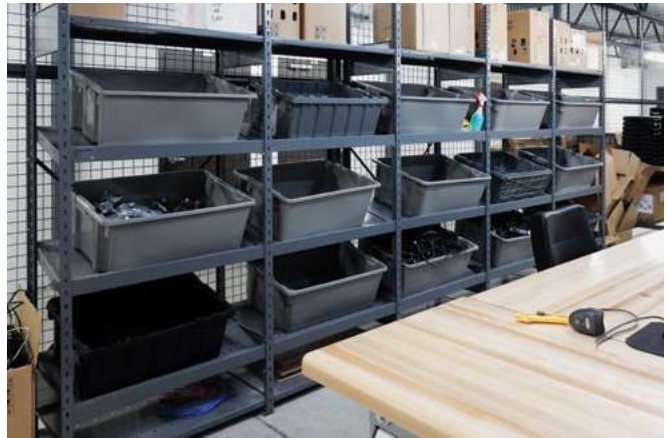
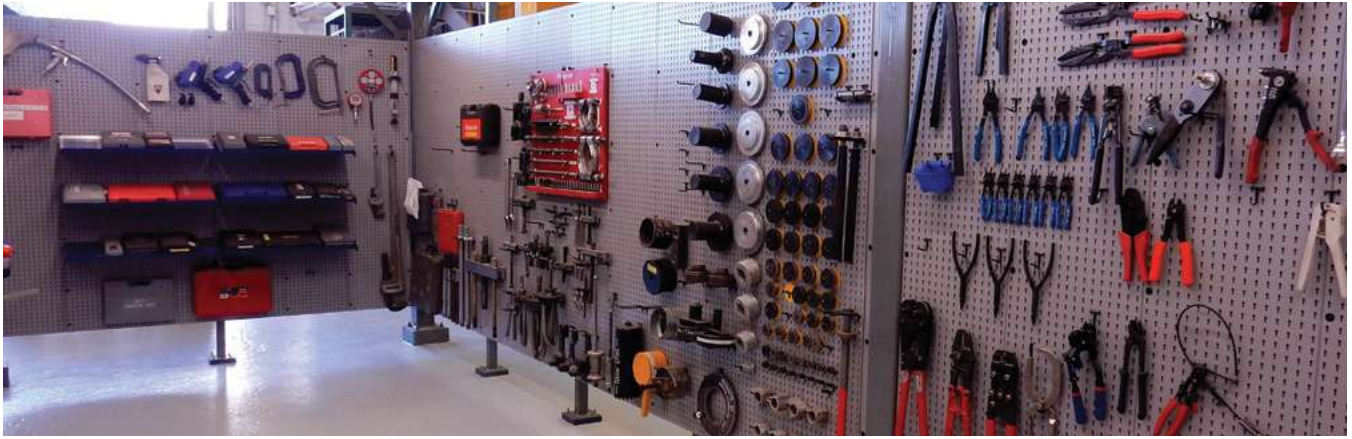



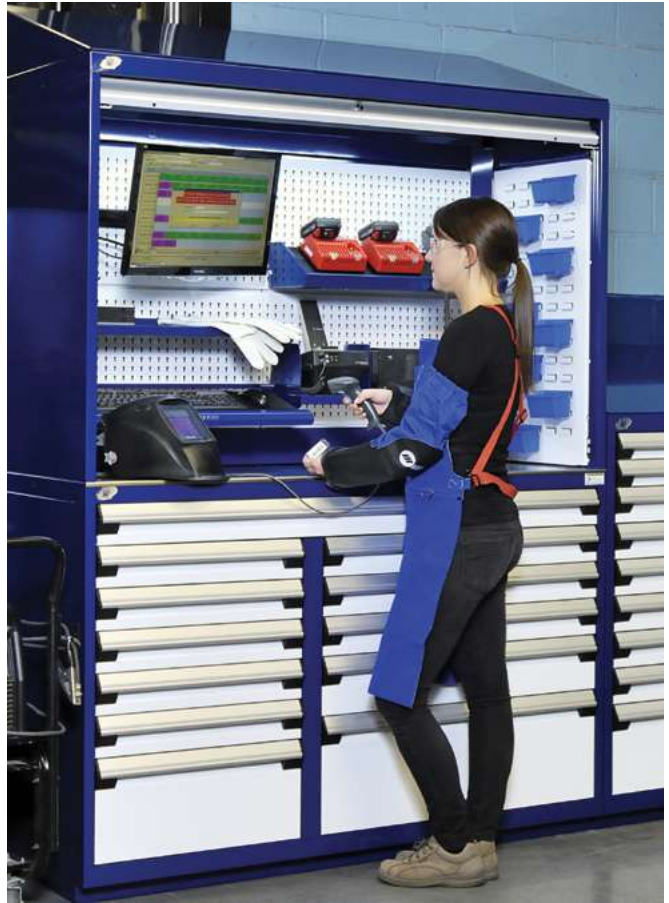







# STANDARD COLORS

HAVING THE ABILITY TO CUSTOMIZE YOUR ROUSSEAU PRODUCT WITH ANY OF OUR 20 STANDARD COLORS IS ALSO DISTINCTIVELY ROUSSEAU!



Everest Blue  
051



Classic Blue  
052



Avalanche Blue  
055



Midnight Blue  
057



Glossy Sapphire Blue  
560

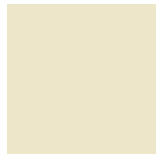

Beige  
041

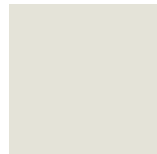

Frost White  
061



Light Gray  
071



Modern Gray  
745



Charcoal Gray  
072



Glossy Carbon Black  
741



White  
616



Glossy EverGreen  
1025



Glossy Yellow  
208



Sienna Orange  
085



Flame Red  
081



Glossy Carmine Red  
806



Glossy Cranberry Red  
815



Black  
091



Glossy Black  
902

FOR PRODUCTS THAT REALLY POP, YOU CAN EVEN COMBINE COLORS. HERE ARE SOME EXAMPLES:



Classic Blue / Frost White  
052/061



Glossy Yellow / Glossy Black  
208/902



Avalanche Blue / Charcoal Gray  
055/072



Glossy Carmine Red / Charcoal Gray  
806/072



Glossy EverGreen / Charcoal Gray  
1025/072



Glossy Cranberry Red / Frost White  
815/061

HANDLE END CAPS:



Black  
031



Orange  
021



Ocean Blue  
011



**CAN'T FIND THE COLOR YOU WANT?**

CONTACT OUR CUSTOMER SERVICE.

\*Colors may differ slightly from those shown.



**THINK  
INNOVATION  
DURABILITY  
QUALITY**

**HERE ARE SOME EXAMPLE MARKETS WHERE ROUSSEAU HAS ALREADY ESTABLISHED ITS REPUTATION:**



**ROUSSEAU METAL INC.**

Since 1950 Rousseau has been designing, engineering and manufacturing modular storage systems for a variety of markets. Our 254,000-square-foot facility, a sign of our growth and vitality, is equipped with cutting-edge technology.

We offer complete and integrated solutions for all your storage needs: drawers for shelving and cabinets, industrial shelving, mini-racking, toolbox systems, workstations and much more.

Visit us at [rousseau.com](http://rousseau.com) for all the details.

For more information, please contact your local distributor:

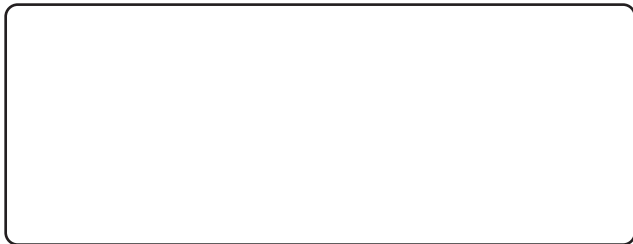

**STANDARD COLORS**

Colors may vary slightly from those shown.

Avalanche Blue <b>055</b>	Everest Blue <b>051</b>	Classic Blue <b>052</b>	Midnight Blue <b>057</b>	Glossy Sapphire Blue <b>560</b>	Glossy EverGreen <b>1025</b>	Black <b>091</b>
Beige <b>041</b>	Frost White <b>061</b>	Light Gray <b>071</b>	Modern Gray <b>745</b>	Charcoal Gray <b>072</b>	Glossy Carbon Black <b>741</b>	White <b>616</b>
Sienna Orange <b>085</b>	Flame Red <b>081</b>	Glossy Carmine Red <b>806</b>	Glossy Cranberry Red <b>815</b>	Glossy Yellow <b>208</b>	Glossy Black <b>902</b>	

Rousseau is continuously improving its products and reserves the right to make any modifications judged necessary.

Product numbers on the cover: RS-C110S, RV-NH37A2U006L3B, RL-XEG76S002NS, R5WH5-2066, R5GHE-3025, TZ-C080S, SXX9001 and NCV-AH620001L3.

**ROUSSEAU METAL INC.**

105, avenue de Gaspé Ouest  
Saint-Jean-Port-Joli (Québec)  
GOR 3G0 CANADA

**DISTRIBUTORS**  
1.800.463.4271

**END USERS**  
1.866.463.4270

**WEBSITE**  
[rousseau.com](http://rousseau.com)

**DISTRIBUTORS ACCESS**  
[e-rousseau.com](mailto:e-rousseau.com)

**CONFIGURATOR**  
[MyModel-r.com](http://MyModel-r.com)

**EMAIL**  
[info@rousseau.com](mailto:info@rousseau.com)



Printed in Canada

# STANDARD COLORS

HAVING THE ABILITY TO CUSTOMIZE YOUR ROUSSEAU PRODUCT WITH ANY OF OUR 20 STANDARD COLORS IS ALSO DISTINCTIVELY ROUSSEAU!



Everest Blue  
051



Classic Blue  
052



Avalanche Blue  
055



Midnight Blue  
057



Glossy Sapphire Blue  
560

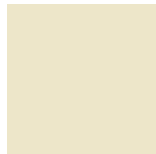

Beige  
041

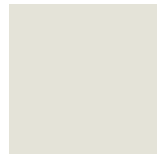

Frost White  
061



Light Gray  
071



Modern Gray  
745



Charcoal Gray  
072



Glossy Carbon Black  
741



White  
616



Glossy EverGreen  
1025



Glossy Yellow  
208



Sienna Orange  
085



Flame Red  
081



Glossy Carmine Red  
806



Glossy Cranberry Red  
815



Black  
091



Glossy Black  
902

FOR PRODUCTS THAT REALLY POP, YOU CAN EVEN COMBINE COLORS. HERE ARE SOME EXAMPLES:



Classic Blue / Frost White  
052/061



Glossy Yellow / Glossy Black  
208/902



Avalanche Blue / Charcoal Gray  
055/072



Glossy Carmine Red / Charcoal Gray  
806/072



Glossy EverGreen / Charcoal Gray  
1025/072



Glossy Cranberry Red / Frost White  
815/061

HANDLE END CAPS:



Black  
031



Orange  
021



Ocean Blue  
011



**CAN'T FIND  
THE COLOR YOU WANT?**

CONTACT OUR CUSTOMER SERVICE.

\*Colors may differ slightly from those shown.



**THINK  
INNOVATION  
DURABILITY  
QUALITY**

**HERE ARE SOME EXAMPLE MARKETS WHERE ROUSSEAU HAS ALREADY ESTABLISHED ITS REPUTATION:**



**ROUSSEAU METAL INC.**

Since 1950 Rousseau has been designing, engineering and manufacturing modular storage systems for a variety of markets. Our 254,000-square-foot facility, a sign of our growth and vitality, is equipped with cutting-edge technology.

We offer complete and integrated solutions for all your storage needs: drawers for shelving and cabinets, industrial shelving, mini-racking, toolbox systems, workstations and much more.

Visit us at [rousseau.com](http://rousseau.com) for all the details.

For more information, please contact your local distributor:



**STANDARD COLORS**

Colors may vary slightly from those shown.

Avalanche Blue <b>055</b>	Everest Blue <b>051</b>	Classic Blue <b>052</b>	Midnight Blue <b>057</b>	Glossy Sapphire Blue <b>560</b>	Glossy EverGreen <b>1025</b>	Black <b>091</b>
Beige <b>041</b>	Frost White <b>061</b>	Light Gray <b>071</b>	Modern Gray <b>745</b>	Charcoal Gray <b>072</b>	Glossy Carbon Black <b>741</b>	White <b>616</b>
Sienna Orange <b>085</b>	Flame Red <b>081</b>	Glossy Carmine Red <b>806</b>	Glossy Cranberry Red <b>815</b>	Glossy Yellow <b>208</b>	Glossy Black <b>902</b>	

Rousseau is continuously improving its products and reserves the right to make any modifications judged necessary.

Product numbers on the cover: RS-C110S, RV-NH37A2U006L3B, RL-XEG76S002NS, R5WH5-2066, R5GHE-3025, TZ-C080S, SXX9001 and NCV-AH620001L3.

**ROUSSEAU METAL INC.**

105, avenue de Gaspé Ouest  
Saint-Jean-Port-Joli (Québec)  
GOR 3G0 CANADA

**DISTRIBUTORS**  
1.800.463.4271

**END USERS**  
1.866.463.4270

**WEBSITE**  
[rousseau.com](http://rousseau.com)

**DISTRIBUTORS ACCESS**  
[e-rousseau.com](mailto:e-rousseau.com)

**CONFIGURATOR**  
[MyModel-r.com](http://MyModel-r.com)

**EMAIL**  
[info@rousseau.com](mailto:info@rousseau.com)



Printed in Canada